

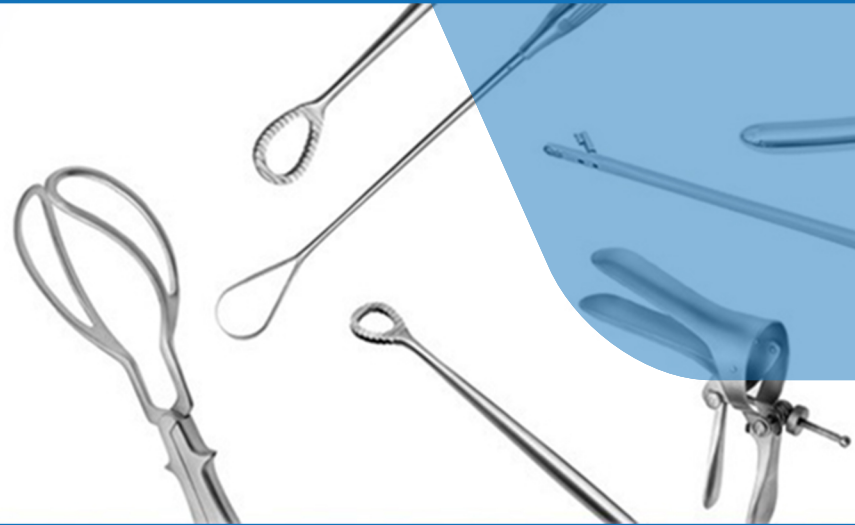

**Hospita
Surgical
Instruments**

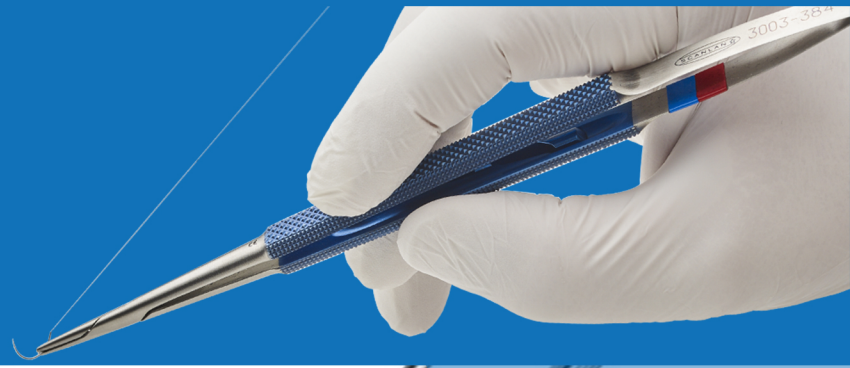

**General Surgical
Instruments**

HOSPITA[®]
ALWAYS THE BEST

GENERAL SURGICAL INSTRUMENT SETS AND RETRACTORS

**ENT, CARDIOVASCULAR, OBGYN, ORTHOPEDIC, PLASTIC SURGERY,
OPHTHALMIC, NEUROSURGERY, DENTAL AND OTHER SURGICAL SETS.**

General Instruments



+44 20 3432 6757



info@hospita.co
www.hospita.co



UK Office: 34-35 Hatton Garden, Holborn, London, United Kingdom.

HOSPITA[®]

Surgical Instruments ▪ Chirurgische Instrumente ▪ Instrumentos para quirúrgicos
Instruments de chirurgie ▪ Strumenti chirurgici

CODE, PAGE & LOGO GUIDE

Company Name & Logo
Firmenname und Logo
Nombre y logotipo de la compañía
Nom et logo de l'entreprise
Nome e il logo

HOSPITA® ALWAYS THE BEST

Operating Scissors
Chirurgische Scheren
Tijeras quirúrgicas
Ciseaux chirurgicaux
Forbici per chirurgia

SS

SCISSORS

Product Sub Group
Produkt-Untergruppe
Producto Sub Grupo
Produit Sous-groupe
Prodotto Sub Gruppo

Product Group
Produktgruppe
Grupo de productos
Groupe de produits
Gruppo prodotti

Product Picture & Profile
Produkt Bild und Profil
Cuadro del producto y Perfil
Image de produit et de profil
Immagine del prodotto e il profilo

Operating Scissors
Straight, Sharp/Blunt

Catalog #	Size
SS-004-13 SC	13 cm (5")
SS-004-14 SC	14.5 cm (5 ¾")

Operating Scissors
Curved, Sharp/Blunt

Catalog #	Size
SS-005-11	12 cm (4 ¾")
SS-005-13	13 cm (5")
SS-005-14	14.5 cm (5 ¾")
SS-005-16	16.5 cm (6 ½")
SS-005-18	18.5 cm (7 ¼")
SS-005-20	20.5 cm (8")

Operating Scissors
Curved, Sharp/Blunt,

Catalog #	Size
SS-005-13 SC	13 cm (5")
SS-005-14 SC	14.5 cm (5 ¾")

Operating Scissors
Straight, Sharp/Sharp

Catalog #	Size
SS-006-11	12 cm (4 ¾")
SS-006-13	13 cm (5")
SS-006-14	14.5 cm (5 ¾")
SS-006-16	16.5 cm (6 ½")
SS-006-18	18.5 cm (7 ¼")
SS-006-20	20.5 cm (8")

Web: www.surtex-instruments.co.uk E-mail: sales@surtex-instruments.co.uk

28

Author /
Product Information
Autor /
Produktinformationen
Autor /
Información de producto
Auteur /
Information produit
Autore /
Informazioni sul prodotto

SS-006-11

SS Product group of discipline

006 Consecutive number within the group or discipline

11 Size/shaped of the product

SS Artikelgruppe oder Disziplin

006 Laufende Nummer innerhalb der Gruppe oder Disziplin

11 Größe/Figur des Instruments

SS Grupo de artículos o especialidad

006 Número corrido dentro del grupo o especialidad

11 Tamaño/forma del instrumento

SS Groupe d'articles ou discipline

006 Numéro courant au sein du groupe ou de la discipline

11 taille/forme de l'instrument

SS Gruppo di articoli o, disciplina

006 Numero progressivo all'interno del gruppo o della disciplina

11 Dimensioni/forma dello strumento

TECHNICAL TERMS TRANSLATION TABLE

English	German	French	Italian	Spanish
Accessories	Zubehör	Accessoires	Accessori	Accesorios
Adjustable	Verstellbar	Réglable	Adeguabile	Ajustable
Adult size	Erwachsengröße	Taille adulte	Misura Adulto	Tamaño adulto
Angled	Gewinkelt	Coudé	Piegato	Acodado
Arm	Arm	Bras	Braccio	Braso
Articulation	Gelenkverbindung	Articulation	Articolazione	Articulación
Atrauma	Atraumatisch	Atraumatique	Atraumatico	Atraumático
Ball Type	Kugelende	Embout sphérique	Puntale A Palla	Punta con bola
Blade	Blatt, Valve	Valve	Valva	Valva
Blunt	Stumpf	Mousse	Smusso	Romo
Bone	Knochen	Os	Ossa	Hueso
Bone rongeur	Knochenzange	Gouge	Sgorbia	Gubia
Child size	Kindergröße	Taille enfant	Misura Pediatrica	Tamaño niño
Circumflex	Zirkumflex	Circonflexe	Circonflesso	Circunflejo
Counterbalanced	Gegengewichtig	Contre poids	Contropeso	Contra peso
Curved	Gebogen	Courbe	Curvo	Curvo
Delicate	Ampfindlich	Délicat	Delicato	Delicado
Depth	Tiefe	Profondeur	Profondità	Profundidad
Dissecting	Sezierung	Dissection	Dissezione	Dissección
Dissector	Dissektor	Dissecteur	Dissettore	Dissector
External	Aussen Liegend	Externe	Esterno	Externo
Fine	Dünn, Fein	Fin	Fino	Fino
Fingerplate	Fingerplatte	Contrôle au doigt	Controllo Digitale	Control digital
Flat	Flach, Eben	Plat	Piatto	Plano
Forceps	Pinzette	Pince	Pinza	Pinza
Hand retractor	Handretraktor	Valve à main	Divaricatore A Mano	Separador a mano
Handle	Griff, Stiel	Manche	Manico	Mango
Height	Höhe	Hauteur	Altezza	Altura
Hook	Haken	Crochet	Gancio	Gancho
Infant	Kleinkind	Nourisson	Bambino	Niño de pecho
Jaws	Kinnbacken	Mors	Morso	Boca
Knot pusher	Schlingengabel	Pousse noeud	Stringinodo	Empujador de nudo
Large	Gross	Grand	Grande	Alto
Left	Links	Gauche	Sinistro	A la izquierda
Length	Länge	Longueur	Lunghezza	Longitud
Ligature	Unterbindung	Ligature	Ligatura	Ligatura
Lung	Lunge	Poumon	Polmone	Pulmón
Medium	Mittel	Moyen	Medio	Medio
Multipurpose	Mehrzweck	Multi-fonctions	Funzione Multipla	Multi-función
Needle holder	Nadelhalter	Porte aiguille	Portaghi	Porta agujas
Needle pulling	Nadelaufnehmer	À saisir les aiguilles	Pinza Stringi Ago	Para coger las agujas
Newborn	Neugeborenen	Nouveau né	Neonato	Recién nacido
On Flat	Flach	Sur le plat	Piatto En	En el plano
Opening	Öffnung	Ouverture	Apertura	Apertura
Pair	Paar	Paire	Paia	Pár
Prong	Zinke	Griffe	Denti	Dientes
Rack	Gestell	Crémaillère	Cremagliera	Cremallera
Raspatory	Schabeisen	Rugine	Raschiatoio	Raspador
Ratchet	Sperre	Crémaillère	Cremagliera	Cremallera
Retractor	Retraktor	Ecarteur	Divaricatore	Separador
Rib contractor	Rippenschliesser	Rapprocheur de côtes	Appaltatore DI Costole	Aproximador costal
Right	Rechts	Droite	Destra	A la derecha
Ring Handle	Ringgriff	A anneaux	Ad Anelli	Con anillos
Ring Tip	Ringspitze	Embout en anneau	Punta Ad Anelli	Punta con anillo
Rongeur	Knochenzange	Gouge	Sgorbia	Gubia
Round	Rund	Rond	Ton Do	Redondo
Scissors	Schere	Ciseaux	Forbici	Tijeras
Serrated	Gezähnt	Strié	Striato	Estriado
Shanks	Schenkel	Branches	Rarno	Mango
Sharp	Scharf	Acéré	Acute	Acerado
Small	Klein	Petit	Piccolo	Pequeño
Smooth	glatt	Lisse	Liscio	Liso
Spatula	Spatel	Spatule	Spatula	Espátula
Straight	Gerade	Droit	Dritto	Recto
Suction tube	Saugrohr	Canule d'aspiration	Canula DI Aspiraione	Cánula de aspiración
Suture passer	Suture passer	Tire-Fil	Passa-fili	Pasa-hilo
Teeth	Zähne	Dents	Denti	Dientes
Thermic purge	Thermische	Purgeur	Purgatore	Purgador
Thin	Dünn	Etroit	Ristretto	Estrecho
Thread	Faden, Zwirn	Torsade	Filo	Hilo
Tip	Spitze	Bout	Estremità	Punta
Tissue seizing	Gewebegrasse	Préhension	Presca	Presión
Twister	Dreher	Pince à torsader	Cerchiatura	Pinza para retorcer
Tying forceps	Binden	Dissection	Dissezione	Dissección
Vessel	Gefäß	Vaisselleau	Vaso	Vaso
Width	Breite / Weite	Largeur	Larghezza	Anchura
Wire Cutter	Drahtschneider	Coupe-Fils	Taglia Cavo	Alicata para cortar alambre
With / Without	Mit / Ohne	Avec / Sans	Con / Senza	Con / Sin

TABLE OF CONTENTS









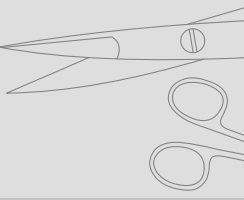
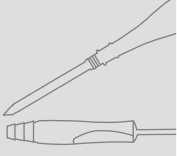

<p>SL</p> <p>Scalpel Skalpelle Bisturies Bistouris Bisturi</p>  <p>• Page • Seite • página • page • pagina 1 - 25</p>	<p>DI</p> <p>Diagnostics Diagnostik Diagnóstico Diagnostic Diagnostica</p>  <p>• Page • Seite • página • page • pagina 387 - 397</p>
<p>SS</p> <p>Scissors Scheren Tijeras Ciseaux Forbici</p>  <p>• Page • Seite • página • page • pagina 26 - 140</p>	<p>TR</p> <p>Trocars, Suction Tubes, Cannulas Trokare, Sauger, Kanülen Trócares, Tubos de Aspiración, Cánulas Trocarts, Tubes d'aspiration, Canules Trequarti, Tubi d'aspirazione, Cannule</p>  <p>• Page • Seite • página • page • pagina 398 - 416</p>
<p>FR</p> <p>Forceps Pinzetten Pinzas Pinces Pinze</p>  <p>• Page • Seite • página • page • pagina 141 - 214</p>	<p>AN</p> <p>Anesthesia Narkose Anestesia Anesthésie Anestesia</p>  <p>• Page • Seite • página • page • pagina 417 - 426</p>
<p>AF</p> <p>Artery Forceps Arterienklemmen Pinzas hemostáticas Pinces hémostatiques Pinze emostatiche</p>  <p>• Page • Seite • página • page • pagina 215 - 279</p>	<p>SU</p> <p>Suture Naht Sutura Suture Sutura</p>  <p>• Page • Seite • página • page • pagina 427 - 483</p>
<p>SF</p> <p>Cotton Swap Forceps Tupfer- und Korzangen Pinzas para tapones y curaciones Pinces á tampons et á pansements Pinze per tamponi e per medicazione</p>  <p>• Page • Seite • página • page • pagina 280 - 287</p>	<p>DR</p> <p>Dressings Verband Vendajes Pansements Bendaggi</p>  <p>• Page • Seite • página • page • pagina 484 - 488</p>
<p>RT</p> <p>Retractor Wundhaken Separdores Ecarteurs Divaricatori</p>  <p>• Page • Seite • página • page • pagina 288 - 375</p>	<p>OR</p> <p>Bone Surgery Knochenchirurgie Cirugía ósea Chirurgie osseuse Chirurgia ossea</p>  <p>• Page • Seite • página • page • pagina 489 - 599</p>
<p>PR</p> <p>Probes, Applicators, Spatulas Sonden, Watteträger, Spatel Sondas, Porta-algodones, Espátulas Sondes, porte-cotons, spatules Sonde, Portacotoni, Spatole</p>  <p>• Page • Seite • página • page • pagina 376 - 386</p>	<p>DM</p> <p>Dermatology Dermatologie Dermatología Dermatologie Dermatologia</p>  <p>• Page • Seite • página • page • pagina 600 - 604</p>

TABLE OF CONTENTS

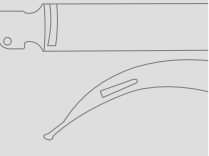
<p>SI</p> <p>Stomach, Intestine & Rectum Magen, Darm, Rektum Estómago, Intestinos, Recto Estomac, Intestins, Rectum Stomaco, Intestini, Retto</p> 	<p>HW</p> <p>Holloware Hohlwaren Holloware Platerie Holloware</p> 
<p>• Page • Seite • página • page • pagina 605 - 633</p>	<p>• Page • Seite • página • page • pagina 647 - 657</p>
<p>UR</p> <p>Liver, Gall Bladder, Kidney & Urology Leber, Galle, Niere, Urologie Higado, Biliares, Renales, Urología Foie, Biliaire, Rénaux, Urologie Fegato, Biliari, Renali, Urologia</p> 	
<p>• Page • Seite • página • page • pagina 634 - 646</p>	

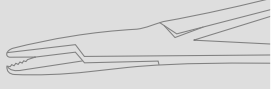

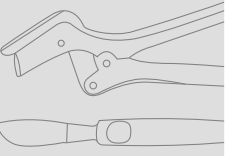
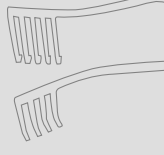
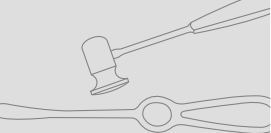
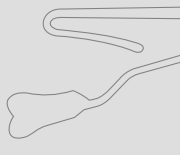
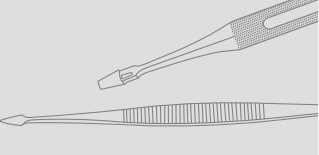
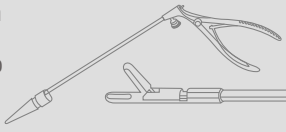
HOSPITA®

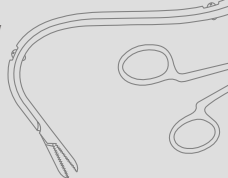
ALWAYS THE BEST



SL

SCALPELS, KNIVES

Hospita scalpel handles and blades are set apart due to their precision, consistency and reliability. A preferred choice of health care professionals worldwide, the brand offers a comprehensive range that caters to all surgical disciplines



Skalpelle, Messer

Bisturís, Cuchillos

Bistouris, Couteaux

Bisturi, Coltelli

Scalpel Handles
 Skalpellgriffe
 Mangos de bisturíes
 Manches pour bistouris
 Manici per bisturi

Scalpel Handle # 3
 Solid



Catalog #	Size
SL-010-03	12 cm (4 3/4")

Scalpel Handle # 4
 Solid



Catalog #	Size
SL-010-04	13.5 cm (5 1/4")

Scalpel Handle # 3 & 4
 Solid, Double Ended



Catalog #	Size
SL-010-34	16 cm (6 1/4")

Scalpel Handle # 3
 Solid, CM Graduation



Catalog #	Size
SL-012-03	12 cm (4 3/4")

Scalpel Handle # 3L
 Solid, Long



Catalog #	Size
SL-020-13	21.5 cm (8 1/2")

Scalpel Handles
 Skalpellgriffe
 Mangos de bisturios
 Manches pour bistouris
 Manici per bisturi

Scalpel Handle # 4L
 Solid, Long



Catalog #	Size
SL-020-14	21 cm (8 1/4")

Scalpel Handle # 3L
 Solid, Angled, Long

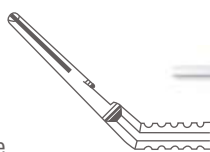

Catalog #	Size
SL-021-13	21 cm (8 1/4")

Scalpel Handle # 4L
 Solid, Angled, Long

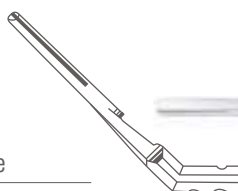

Catalog #	Size
SL-021-14	21 cm (8 1/4")

Scalpel Handle # 7
 Solid



Catalog #	Size
SL-030-07	16 cm (6 1/4")

Scalpel Handle # 7K
 Solid, Short



Catalog #	Size
SL-030-17	12.5 cm (5")

Scalpel Handles
 Skalpellgriffe
 Mangos de bisturíes
 Manches pour bistouris
 Manici per bisturi

Collin Scalpel Handle # 8
 With Hollow Handle



Catalog #	Size
SL-032-08	13.5 cm (5 1/4")

Collin Scalpel Handle # 9
 With Hollow Handle



Catalog #	Size
SL-032-09	14.5 cm (5 3/4")

Scalpel Handle # 3
 With Round Hollow Handle



Catalog #	Size
SL-050-03	15.5 cm (6")

Scalpel Handle # 3
 Solid, Round Handle



Catalog #	Size
SL-052-03	14.5 cm (5 3/4")

Scalpel Handle # 3
 Solid, Round Handle, Angled



Catalog #	Size
SL-053-03	14 cm (5 1/2")

Scalpel Blades
Skalpellklingen
Hojas de bisturios
Lames pour bistouris
Lame per bisturi

Kaye Scalpel Handle # 3
Solid, Round Handle



Catalog #	Size
SL-056-03	15 cm (6")

Scalpel Blade # 10
Pack of 100

Catalog #	Shape
SL-100-10	Fig. 10



Scalpel Blade # 11
Pack of 100

Catalog #	Shape
SL-100-11	Fig. 11



Scalpel Blade # 12
Pack of 100

Catalog #	Shape
SL-100-12	Fig. 12

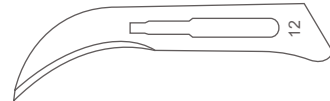

Scalpel Blade # 13
Pack of 100

Catalog #	Shape
SL-100-13	Fig. 13



Scalpel Blades
 Skalpellklingen
 Hojas de bisturios
 Lames pour bistouris
 Lame per bisturi

Scalpel Blade # 15
 Pack of 100

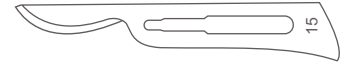

Catalog #	Shape
SL-100-15	Fig. 15

Scalpel Blade # 16
 Pack of 100

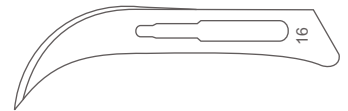

Catalog #	Shape
SL-100-16	Fig. 16

Scalpel Blade # 17
 Pack of 100



Catalog #	Shape
SL-100-17	Fig. 17

Scalpel Blade # 18
 Pack of 100



Catalog #	Shape
SL-100-18	Fig. 18

Scalpel Blade # 19
 Pack of 100

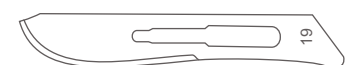

Catalog #	Shape
SL-100-19	Fig. 19



Scalpel Blades
Skalpellklingen
Hojas de bisturios
Lames pour bistouris
Lame per bisturi

Scalpel Blade # 20
Pack of 100

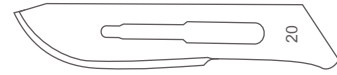

Catalog #	Shape
SL-100-20	Fig. 20

Scalpel Blade # 21
Pack of 100



Catalog #	Shape
SL-100-21	Fig. 21

Scalpel Blade # 22
Pack of 100



Catalog #	Shape
SL-100-22	Fig. 22

Scalpel Blade # 23
Pack of 100



Catalog #	Shape
SL-100-23	Fig. 23

Scalpel Blade # 24
Pack of 100



Catalog #	Shape
SL-100-24	Fig. 24

Scalpel Blades
 Skalpelling
 Hojas de bisturíes
 Lames pour bistouris
 Lame per bisturi

Scalpel Blade # 34
 Pack of 100

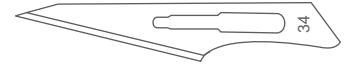

Catalog #	Shape
SL-100-34	Fig. 34

Scalpel Blade # 12D
 Pack of 100

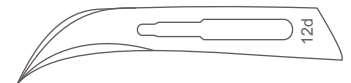

Catalog #	Shape
SL-101-12	Fig. 12D

Scalpel Blade # 15C
 Pack of 100

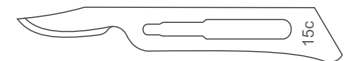

Catalog #	Shape
SL-101-15	Fig. 15C

Scalpel Blade # 36
 Pack of 100



Catalog #	Shape
SL-100-36	Fig. 36

Scalpel Blade Remover



Catalog #	Size
SL-150-00	Standard



Scalpel Blades
 Skalpellklingen
 Hojas de bisturios
 Lames pour bistouris
 Lame per bisturi

Scalpel Handle

For Micro Scalpel Blades, Titanium



Catalog #	Size
SL-200-00	13.5 cm (5 1/4")

Scalpel Handle

For Micro Scalpel Blades, Stainless Steel



Catalog #	Size
SL-202-00	13.5 cm (5 1/4")

Caspar Scalpel Handle



Catalog #	Size
SL-204-00	18 cm (7")

Scalpel Handle

For Micro Scalpel Blades



Catalog #	Size
SL-206-10	10 cm (4")
SL-206-13	13 cm (5")
SL-206-15	15 cm (6")

Landolt Scalpel Handle

Bayonet Shaped, Round Handle



Catalog #	Size
SL-207-00	25 cm (10")

Scalpel Blades
 Skalpellingin
 Hojas de bisturios
 Lames pour bistouris
 Lame per bisturi

Landolt Scalpel Handle
 Bayonet Shaped, Square Handle



Catalog #	Size
SL-209-00	21 cm (8 1/4")

Micro Scalpel Blade # 61
 Pack of 25



Catalog #	Shape
SL-210-61	Fig. 61

Micro Scalpel Blade # 62
 Pack of 25



Catalog #	Shape
SL-210-62	Fig. 62

Micro Scalpel Blade # 63
 Pack of 25



Catalog #	Shape
SL-210-63	Fig. 63

Micro Scalpel Blade # 64
 Pack of 25



Catalog #	Shape
SL-210-64	Fig. 64



Scalpel Blades
 Skalpellklingen
 Hojas de bisturios
 Lames pour bistouris
 Lame per bisturi

Micro Scalpel Blade # 65
 Pack of 25

Catalog #	Shape
SL-210-65	Fig. 65



Micro Scalpel Blade # 66
 Pack of 25

Catalog #	Shape
SL-210-66	Fig. 66



Micro Scalpel Blade # 67
 Pack of 25

Catalog #	Shape
SL-210-67	Fig. 67



Micro Scalpel Blade # 68
 Pack of 25

Catalog #	Shape
SL-210-68	Fig. 68

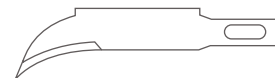

Micro Scalpel Blade # 69
 Pack of 25

Catalog #	Shape
SL-210-69	Fig. 69



Operating Knives
 Operating Skalpelle
 Bisturíes para operaciones
 Bistouris pour opérations
 Bisturi per interventi

Operating Knife

With Metal Handle, Blade Size 35 mm



Catalog #	Size
SL-300-07	15 cm (6")

Operating Knife

With Metal Handle, Blade Size 40 mm



Catalog #	Size
SL-300-08	16 cm (6 1/4")

Operating Knife

With Metal Handle, Blade Size 30 mm



Catalog #	Size
SL-300-01	15 cm (6")

Operating Knife

With Metal Handle, Blade Size 36 mm



Catalog #	Size
SL-300-02	15 cm (6")

Operating Knife

With Metal Handle, Blade Size 40 mm



Catalog #	Size
SL-300-03	15.5 cm (6")

INCHES
MILLIMETERS

Operating Knives
 Operating Skalpelle
 Bisturios para operaciones
 Bistouris pour opérations
 Bisturi per interventi

Operating Knife

With Metal Handle, Blade Size 45 mm



Catalog #	Size
SL-300-04	16 cm (6 1/4")

Operating Knife

With Metal Handle, Blade Size 50 mm



Catalog #	Size
SL-300-05	16 cm (6 1/4")

Operating Knife

With Metal Handle, Blade Size 27 mm



Catalog #	Size
SL-300-06	15 cm (6")

Operating Knife

With Metal Handle, Blade Size 47 mm



Catalog #	Size
SL-300-09	16 cm (6 1/4")

Operating Knife

With Metal Handle, Blade Size 50 mm



Catalog #	Size
SL-300-10	17 cm (6 3/4")

Operating Knives
 Operating Skalpelle
 Bisturíes para operaciones
 Bistouris pour opérations
 Bisturi per interventi

Dieffenbach Operating Knife
 With Metal Handle



Catalog #	Size
SL-310-01	17 cm (6 3/4")

Dieffenbach Operating Knife
 With Metal Handle



Catalog #	Size
SL-310-02	17 cm (6 3/4")

Dieffenbach Operating Knife
 With Metal Handle



Catalog #	Size
SL-310-03	17 cm (6 3/4")

Dieffenbach Operating Knife
 With Metal Handle



Catalog #	Size
SL-310-04	17 cm (6 3/4")

Dieffenbach Operating Knife
 With Metal Handle



Catalog #	Size
SL-310-05	17 cm (6 3/4")

INCHES
 MILLIMETERS

Operating Knives
 Operating Skalpelle
 Bisturios para operaciones
 Bistouris pour opérations
 Bisturi per interventi

Dieffenbach Operating Knife
 With Metal Handle



Catalog #	Size
SL-310-06	17 cm (6 3/4")

Dieffenbach Operating Knife
 With Metal Handle



Catalog #	Size
SL-310-07	17 cm (6 3/4")

Dieffenbach Operating Knife
 With Metal Handle



Catalog #	Size
SL-310-08	17 cm (6 3/4")

Dieffenbach Operating Knife
 With Metal Handle



Catalog #	Size
SL-310-09	17 cm (6 3/4")

Dieffenbach Operating Knife
 With Metal Handle

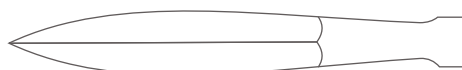

Catalog #	Size
SL-310-15	17 cm (6 3/4")

Operating Knives
 Operating Skalpelle
 Bisturíes para operaciones
 Bistouris pour opérations
 Bisturi per interventi

Dieffenbach Operating Knife
 With Metal Handle



Catalog #	Size
SL-310-16	17 cm (6 3/4")

Bergmann Operating Knife
 With Metal Handle



Catalog #	Size
SL-320-14	14 cm (5 1/2")

Operating Knife
 Bellied Blade, Fig. 1



Catalog #	Size
SL-350-01	14 cm (5 1/2")

Operating Knife
 Bellied Blade, Fig. 3



Catalog #	Size
SL-350-03	14 cm (5 1/2")

Operating Knife
 Bellied Blade, Fig. 4



Catalog #	Size
SL-350-04	14 cm (5 1/2")

INCHES
 MILLIMETERS

Operating Knives
 Operating Skalpelle
 Bisturios para operaciones
 Bistouris pour opérations
 Bisturi per interventi

Operating Knife
 Bellied Blade, Fig. 6



Catalog #	Size
SL-350-06	14 cm (5 1/2")

Operating Knife
 Bellied Blade, Fig. 7



Catalog #	Size
SL-350-07	14 cm (5 1/2")

Operating Knife
 Bellied Blade, Fig. 8



Catalog #	Size
SL-350-08	14 cm (5 1/2")

Operating Knife
 Bellied Blade, Fig. 9



Catalog #	Size
SL-350-09	14 cm (5 1/2")

Operating Knife
 Sharp Pointed Blade, Fig. 14



Catalog #	Size
SL-350-14	14 cm (5 1/2")

Operating Knives, Post Mortem Knives
 Operating Skalpelle, Organmesser
 Bisturíes para operaciones, Cuchillos para órganos
 Bistouris pour opérations, Couteaux à autopsie
 Bisturi per interventi, Coltelli per autopsia

Operating Knife

Sickle Shaped Blade, Fig. 46



Catalog #	Size
SL-361-46	14 cm (5 1/2")



Operating Knife

Tenotome, Fig. 63



Catalog #	Size
SL-363-63	14 cm (5 1/2")



Virchow Autopsy Knife

With Wooden Handle, Blade Size 100 mm



Catalog #	Size
SL-400-10	25.5 cm (10")

Virchow Cartilage Knife

With Wooden Handle, Blade Size 80 mm



Catalog #	Size
SL-402-08	21 cm (8 1/4")

Post Mortem Knives, Brain Knives, Amputation Knives
Organmesser, Hirnmesser, Amputationsmesser
Cuchillos para órganos, Cuchillos para cerebro, Cuchillos para amputación
Couteaux à autopsie, Couteaux à cerveaux, Couteaux à amputation
Coltelli per autopsia, Coltelli per cervello, Coltelli per amputazione

Walb Post Mortem Knife With Wooden Handle



Catalog #	Size
SL-410-11	26 cm (10 ¼"), Blade Size 110 mm
SL-410-14	29 cm (11 ½"), Blade Size 140 mm
SL-410-17	31 cm (12 ¼"), Blade Size 170 mm

Virchow Brain Knife With Hollow Handle



Catalog #	Size
SL-420-16	26 cm (10 ¼"), Blade Size 160 mm
SL-420-20	33.5 cm (13 ¼"), Blade Size 200 mm
SL-420-24	38 cm (15"), Blade Size 240 mm

Liston Amputation Knife With Hollow Handle



Catalog #	Size
SL-450-13	26 cm (10 ¼"), Blade Size 130 mm
SL-450-16	29 cm (11 ½"), Blade Size 160 mm
SL-450-19	32.5 cm (12 ¾"), Blade Size 190 mm
SL-450-22	35 cm (13 ¾"), Blade Size 220 mm

Amputation Knives
 Amputationsmesser
 Cuchillos para amputación
 Couteaux à amputation
 Coltelli per amputazione

Catlin Amputation Knife

With Hollow Handle, Blade Size 160 mm



Catalog #	Size
SL-460-16	29 cm (11 1/2")

Langenbeck Flap Knife

Blade Size 120 mm



Catalog #	Size
SL-470-12	25 cm (9 3/4")

Phalangeal Knife

Blade Size 105 mm



Catalog #	Size
SL-472-10	23.5 cm (9 1/4")

Interosseous Knife

Blade Size 110 mm



Catalog #	Size
SL-474-11	24 cm (9 1/2")

Resection Knife

Solid Handle, Dissecting End, Blade Size 65 mm



Catalog #	Size
SL-480-65	19 cm (7 1/2")

Amputation Knives, Fistula Knives
 Amputationsmesser, Fistelmesser
 Cuchillos para amputación, Bisturios para fistulas
 Couteaux à amputation, Bistouris à fistules
 Coltelli per amputazione, Bisturi per fistole

Langenbeck Resection Knife

Blade Size 55 mm



Catalog #	Size
SL-482-55	18 cm (7")

Langenbeck Resection Knife

Blade Size 55 mm



Catalog #	Size
SL-484-55	18 cm (7")

Simon Fistula Knife

Fig. 1

Catalog #	Size, Profile
SL-488-01	20 cm (8"), Fig. 1
SL-488-02	20 cm (8"), Fig. 2
SL-488-03	20 cm (8"), Fig. 3



SL-488-01, Fig. 1

SL-488-02, Fig. 2

SL-488-03, Fig. 3

Ulrich Fistula Knife

Catalog #	Size
SL-490-22	22.5 cm (9")



Olivecrona Trigeminal Knife

Catalog #	Size
SL-493-20	20.5 cm (8")



Tonsil Knives, Razor Knives
 Tonsillennmesser, Rasiermesser
 Bisturías para amígdalas, Navajas
 Bistouris pour amygdales, Rasoirs
 Bisturi per tonsille, Rasoi

Trigeminal Knife



Catalog #	Size
SL-494-23	23 cm (9")

Fowler Tonsil Knife



Catalog #	Size
SL-501-20	20 cm (8")

Abraham Tonsil Knife



Catalog #	Size
SL-503-21	21 cm (8 1/4")

Masing Cartilage Slitting Knife



Catalog #	Size
SL-505-13	13 cm (5")

Razor Knife

Hollow Blades on Both Side



Catalog #	Size
SL-551-00	Blade Size 75 mm

Razor Knives, Dermatomes
 Rasiermesser, Dermátome
 Navajas, Dermátoms
 Rasoirs, Dermatomes
 Rasoi, Dermatomi

Razor Knife
 Blade Flat/Hollow

Catalog #	Size
SL-553-00	Blade Size 80 mm



Record-Arkansas Sharpening Stone
 In Wooden Case

Catalog #	Size
SL-600-00	150 x 50 mm



Record-Arkansas Sharpening Stone

Catalog #	Size
SL-602-00	Standard



Humby Skin Graft Knife (Dermatome)

Thickness Adjustable From 0.1 to 1.2 mm, Cutting Width Maximum 155 mm

Catalog #	Size
SL-700-32	32 cm (13")



Watson Skin Graft Knife (Dermatome)

Thickness Adjustable From 0.1 to 1.2 mm, Cutting Width Maximum 155 mm

Catalog #	Size
SL-710-30	30.5 cm (12")



Blade Holders / Blade Breakers, Dermatomes
 Klingenhälter / Kingenbrecher, Dermátome
 Porta-hojas / Rompe-hojas de afeitar, Dermátomos
 Pincettes pour saisir et casser les lames de rasoir, Dermatomes
 Pinze per afferrare e rompere le lamette de rasoio, Dermatomi

Skin Graft Knife Blade (Dermatome Blade)

For SL-700-32 and SL-710-30



Catalog #	Size
SL-712-00	15 cm (6")

Schink Skin Graft Knife (Dermatome)

Thickness Adjustable From 0.1 to 1.2 mm, Cutting Width Maximum 100 mm



Catalog #	Size
SL-730-31	31 cm (12 1/4")

Schink Skin Graft Knife Blade (Dermatome Blade)

For SL-730-31



Catalog #	Size
SL-732-00	10 cm (4")

Skin Fixation Plate



Catalog #	Size
SL-734-00	4 cm, 5 cm, 8 cm, 10 cm

Silver Skin Graft Knife (Dermatome)

Thickness Adjustable From 0.1 to 1.2 mm, Cutting Width Maximum 40 mm



Catalog #	Size
SL-740-19	19 cm (7 1/2")

Dermatomes, Blade Holders / Blade Breakers
 Dermatome, Klingenthaler / Kingenbrecher
 Dermátoms, Porta-hojas / Rompe-hojas de afeitár
 Dermatomes, Pincettes pour saisir et casser les lames de rasoír
 Dermatomi, Pinze per afferrare e rompere le lamette de rasoío

Karp Aorta Punch

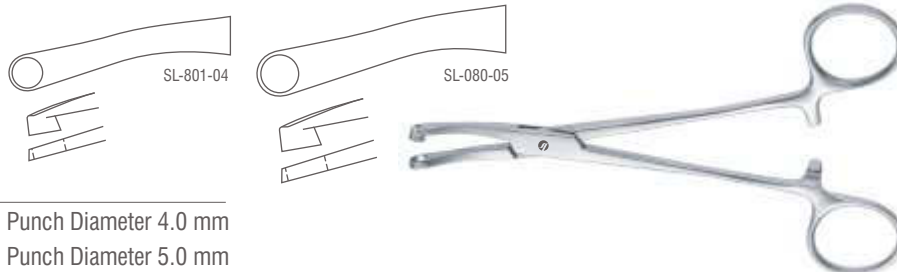

Catalog #	Size, Profile
SL-801-04	16 cm (6 ¼"), Punch Diameter 4.0 mm
SL-801-05	16 cm (6 ¼"), Punch Diameter 5.0 mm

Troutman-Chris Blade Holder/Breaker

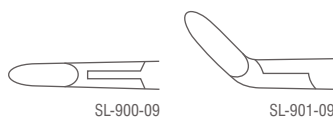

Catalog #	Size, Profile
SL-900-09	9 cm (3 ½"), Round Handle, Straight
SL-901-09	9 cm (3 ½"), Round Handle, Angled

Barraquer Blade Holder/Breaker



Catalog #	Size
SL-910-11	11 cm (4 ¼")

Castroviejo Blade Holder/Breaker Round Handle



Catalog #	Size
SL-916-13	13 cm (5")

Silver Skin Graft Knife Blade Pack of 10

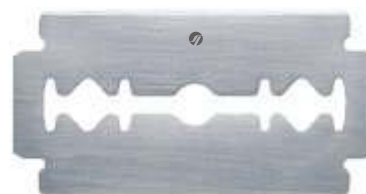

Catalog #	Size
SL-950-10	Standard

HOSPITA®

ALWAYS THE BEST



SS

SCISSORS



Scheren

Tijeras

Torbici

Ciseaux

Operating Scissors
 Chirurgische Scheren
 Tijeras quirúrgicas
 Ciseaux chirurgicaux
 Forbici per chirurgia

Operating Scissors
 Straight, Blunt/Blunt

Catalog #	Size
SS-002-11	12 cm (4 ¾")
SS-002-13	13 cm (5")
SS-002-14	14.5 cm (5 ¾")
SS-002-16	16.5 cm (6 ½")
SS-002-18	18.5 cm (7 ¼")
SS-002-20	20.5 cm (8")



Operating Scissors
 Curved, Blunt/Blunt

Catalog #	Size
SS-003-11	12 cm (4 ¾")
SS-003-13	13 cm (5")
SS-003-14	14.5 cm (5 ¾")
SS-003-16	16.5 cm (6 ½")
SS-003-18	18.5 cm (7 ¼")
SS-003-20	20.5 cm (8")

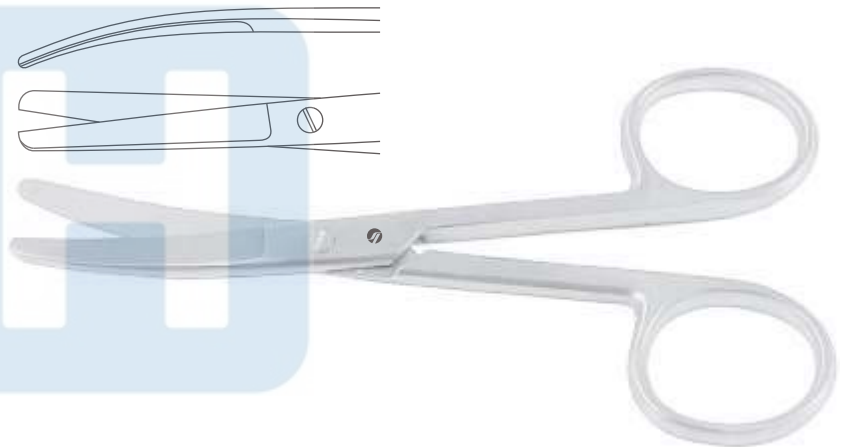

Operating Scissors
 Straight, Sharp/Blunt

Catalog #	Size
SS-004-11	12 cm (4 ¾")
SS-004-13	13 cm (5")
SS-004-14	14.5 cm (5 ¾")
SS-004-16	16.5 cm (6 ½")
SS-004-18	18.5 cm (7 ¼")
SS-004-20	20.5 cm (8")

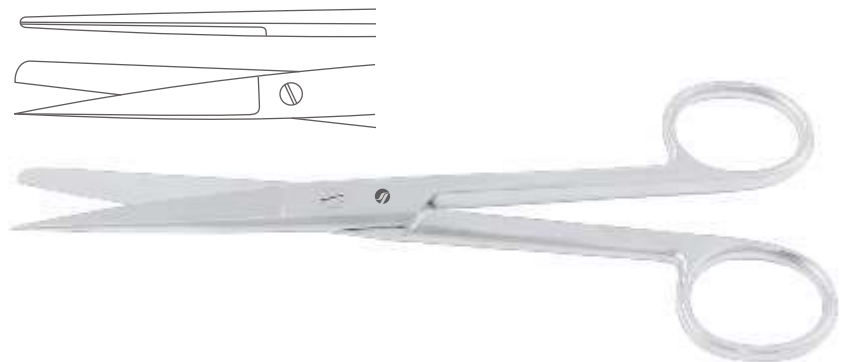

Operating Scissors
Chirurgische Scheren
Tijeras quirúrgicas
Ciseaux chirurgicaux
Forbici per chirurgia

SS

SCISSORS

Operating Scissors
Straight, Sharp/Blunt

SUPER Edge™

Catalog #	Size
SS-004-13 SC	13 cm (5")
SS-004-14 SC	14.5 cm (5 ¾")



Operating Scissors
Curved, Sharp/Blunt

Catalog #	Size
SS-005-11	12 cm (4 ¾")
SS-005-13	13 cm (5")
SS-005-14	14.5 cm (5 ¾")
SS-005-16	16.5 cm (6 ½")
SS-005-18	18.5 cm (7 ¼")
SS-005-20	20.5 cm (8")

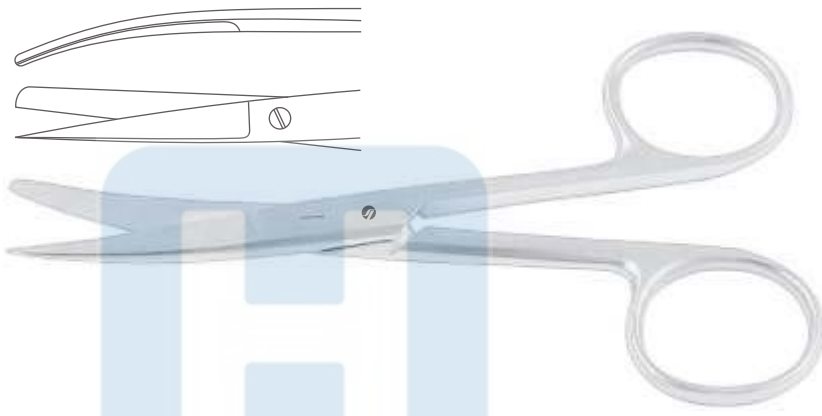

Operating Scissors
Curved, Sharp/Blunt,

SUPER Edge™

Catalog #	Size
SS-005-13 SC	13 cm (5")
SS-005-14 SC	14.5 cm (5 ¾")



Operating Scissors
Straight, Sharp/Sharp

Catalog #	Size
SS-006-11	12 cm (4 ¾")
SS-006-13	13 cm (5")
SS-006-14	14.5 cm (5 ¾")
SS-006-16	16.5 cm (6 ½")
SS-006-18	18.5 cm (7 ¼")
SS-006-20	20.5 cm (8")



Operating Scissors
 Chirurgische Scheren
 Tijeras quirúrgicas
 Ciseaux chirurgicaux
 Forbici per chirurgia

Operating Scissors
 Curved, Sharp/Sharp

Catalog #	Size
SS-007-11	12 cm (4 ¾")
SS-007-13	13 cm (5")
SS-007-14	14.5 cm (5 ¾")
SS-007-16	16.5 cm (6 ½")
SS-007-18	18.5 cm (7 ¼")
SS-007-20	20.5 cm (8")

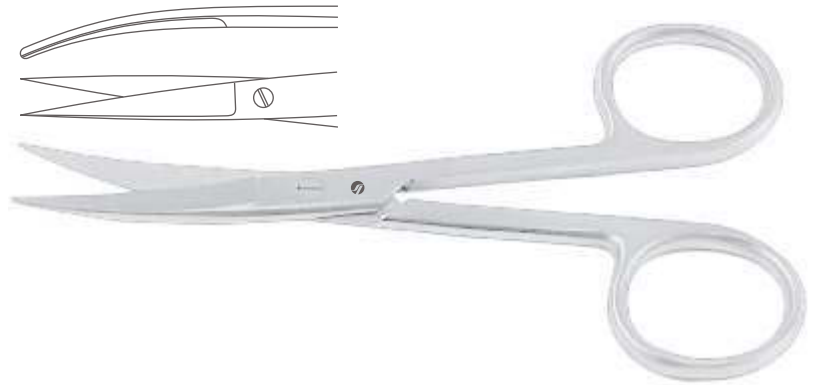

Operating Scissors
 Straight, Blunt/Blunt

Catalog #	Size
SS-010-14	14.5 cm (5 ¾")



Operating Scissors
 Curved, Blunt/Blunt

Catalog #	Size
SS-011-14	14.5 cm (5 ¾")

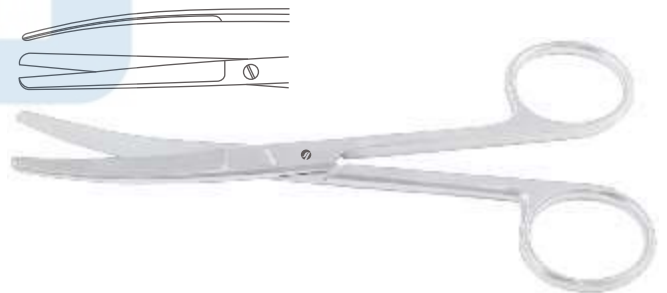

Operating Scissors
 Straight, Sharp/Blunt

Catalog #	Size
SS-012-14	14.5 cm (5 ¾")

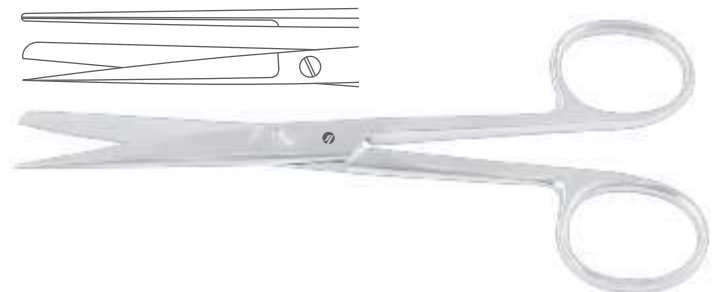

Operating Scissors
Chirurgische Scheren
Tijeras quirúrgicas
Ciseaux chirurgicaux
Forbici per chirurgia

SS

SCISSORS

Operating Scissors
Curved, Sharp/Blunt



Catalog #	Size
SS-013-14	14.5 cm (5 ¾")

Operating Scissors
Straight, Sharp/Sharp

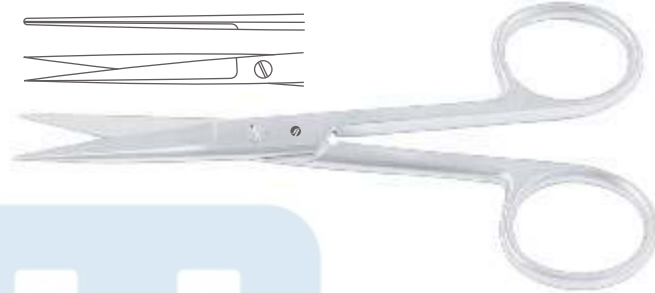

Catalog #	Size
SS-014-14	14.5 cm (5 ¾")

Operating Scissors
Curved, Sharp/Sharp



Catalog #	Size
SS-015-14	14.5 cm (5 ¾")

Incision Scissor
Straight



Catalog #	Size
SS-018-13	13 cm (5")
SS-020-14	14.5 cm (5 ¾")
SS-022-16	16.5 cm (6 ½")

Systrunk Nail Splitting Scissor
Straight



Catalog #	Size
SS-024-13	13 cm (5")

Operating Scissors, Dissecting Scissors
 Chirurgische Scheren, Präparierscheren
 Tijeras quirúrgicas, Tijeras de disección
 Ciseaux chirurgicaux, Ciseaux à dissection
 Forbici per chirurgia, Forbici per dissezione

Deaver Operating Scissor

Straight, Sharp/Blunt

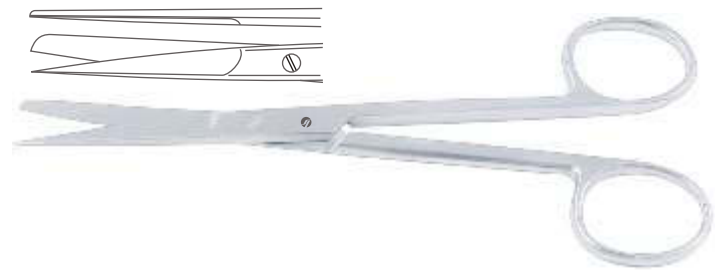

Catalog #	Size
SS-030-14	14 cm (5 1/2")

Deaver Operating Scissor

Curved, Sharp/Blunt

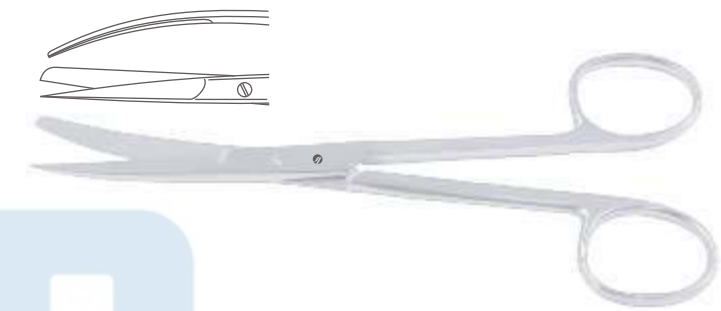

Catalog #	Size
SS-031-14	14 cm (5 1/2")

Mayo Dissecting Scissor

Straight

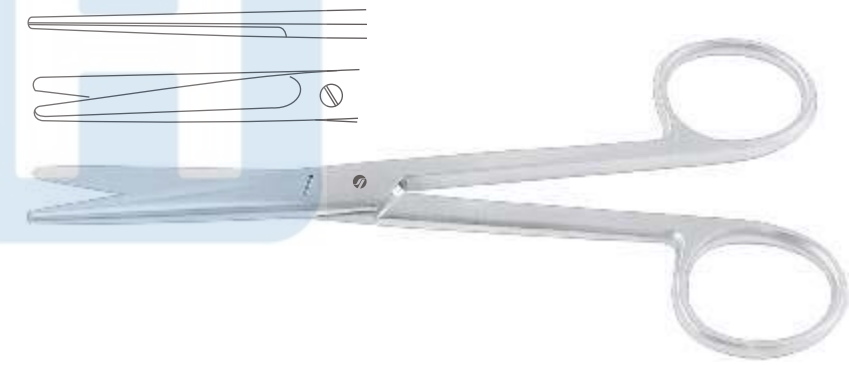

Catalog #	Size
SS-040-14	14.5 cm (5 3/4")
SS-040-15	15 cm (6")
SS-040-17	17 cm (6 3/4")
SS-040-23	23.5 cm (9 1/4")

Mayo Dissecting Scissor

Straight



SUPER Edge™

Catalog #	Size
SS-040-14 SC	14.5 cm (5 3/4")
SS-040-15 SC	15 cm (6")
SS-040-17 SC	17 cm (6 3/4")

Dissecting Scissors
 Präparierscheren
 Tijeras de disección
 Ciseaux à dissection
 Forbici per dissezione

Mayo Dissecting Scissor
 Curved

Catalog #	Size
SS-041-14	14.5 cm (5 ¾")
SS-041-15	15 cm (6")
SS-041-17	17 cm (6 ¾")
SS-041-23	23.5 cm (9 ¼")



Mayo Dissecting Scissor
 Curved

SUPER Edge™

Catalog #	Size
SS-041-14 SC	14.5 cm (5 ¾")
SS-041-15 SC	15 cm (6")
SS-041-17 SC	17 cm (6 ¾")



Mayo Dissecting Scissor
 Straight, With Chamfered Blades

Catalog #	Size
SS-042-19	19 cm (7 ½")
SS-042-21	21.5 cm (8 ½")



Mayo Dissecting Scissor
 Curved, With Chamfered Blades

Catalog #	Size
SS-043-19	19 cm (7 ½")
SS-043-21	21.5 cm (8 ½")



Dissecting Scissors
 Präparierscheren
 Tijeras de disección
 Ciseaux à dissection
 Forbici per dissezione

Mayo-Harrington Dissecting Scissor
 Straight

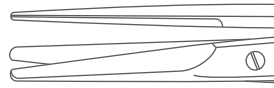

Catalog #	Size
SS-046-23	23 cm (9")

Mayo-Harrington Dissecting Scissor
 Straight



SUPER Edge™

Catalog #	Size
SS-046-23 SC	23 cm (9")

Mayo-Harrington Dissecting Scissor
 Curved



Catalog #	Size
SS-047-23	22.5 cm (9")
SS-047-28	28 cm (11")

Mayo-Harrington Dissecting Scissor
 Curved



SUPER Edge™

Catalog #	Size
SS-047-23 SC	22.5 cm (9")

Dissecting Scissors
 Präparierscheren
 Tijeras de disección
 Ciseaux à dissection
 Forbici per dissezione

Mayo-Stille Dissecting Scissor
 Straight

Catalog #	Size
SS-050-15	15 cm (6")
SS-050-17	17 cm (6 ¾")
SS-050-19	19.5 cm (7 ¾")
SS-050-21	21.5 cm (8 ½")



Mayo-Stille Dissecting Scissor
 Straight

SUPER Edge™

Catalog #	Size
SS-050-15 SC	15 cm (6")
SS-050-17 SC	17 cm (6 ¾")

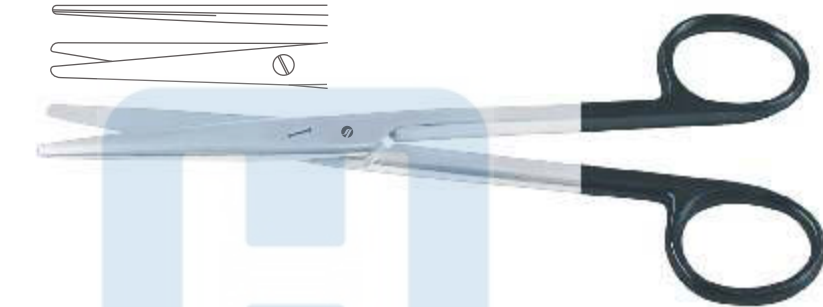

Mayo-Stille Dissecting Scissor
 Curved

Catalog #	Size
SS-051-15	15 cm (6")
SS-051-17	17 cm (6 ¾")
SS-051-19	19.5 cm (7 ¾")
SS-051-21	21.5 cm (8 ½")



Mayo-Stille Dissecting Scissor
 Curved

SUPER Edge™

Catalog #	Size
SS-051-15 SC	15 cm (6")
SS-051-17 SC	17 cm (6 ¾")



Dissecting Scissors, Gynecological Scissors
 Präparierscheren, Gynäkologische Scheren
 Tijeras de disección, Tijeras para ginecología
 Ciseaux à dissection, Ciseaux à gynécologie
 Forbici per dissezione, Forbici per ginecologia

Mayo-Stille Dissecting Scissor
 Straight, With Chamfered Blades

Catalog #	Size
SS-052-14	14 cm (5 1/2")
SS-052-17	17 cm (6 3/4")



Mayo-Stille Dissecting Scissor
 Curved, With Chamfered Blades

Catalog #	Size
SS-053-14	14 cm (5 1/2")
SS-053-17	17 cm (6 3/4")



Stille Dissecting Scissor
 Straight

Catalog #	Size
SS-056-15	15 cm (6")



Stille Dissecting Scissor
 Curved

Catalog #	Size
SS-057-15	15 cm (6")



Mayo-Noble Gynecological Scissor
 Straight

Catalog #	Size
SS-060-17	16.5 cm (6 1/2")



Gynecological Scissors
 Gynäkologische Scheren
 Tijeras para ginecología
 Ciseaux à gynécologie
 Forbici per ginecologia

Mayo-Noble Gynecological Scissor
 Curved

Catalog #	Size
SS-061-17	16.5 cm (6 1/2")



Sims Gynecological Scissor
 Straight

Catalog #	Size
SS-070-20	20 cm (8")
SS-070-23	23 cm (9")



Sims Gynecological Scissor
 Straight

SUPER Edge™

Catalog #	Size
SS-070-20 SC	20 cm (8")
SS-070-23 SC	23 cm (9")



Sims Gynecological Scissor
 Curved

Catalog #	Size
SS-071-20	20 cm (8")
SS-071-23	23 cm (9")



Gynecological Scissors
 Gynäkologische Scheren
 Tijeras para ginecología
 Ciseaux à gynécologie
 Forbici per ginecologia

Sims Gynecological Scissor
 Curved

SUPER Edge[™]

Catalog #	Size
SS-071-20 SC	20 cm (8")
SS-071-23 SC	23 cm (9")



Doyen Gynecological Scissor
 Straight

Catalog #	Size
SS-074-17	18.5 cm (7 1/4")



Doyen Gynecological Scissor
 Curved

Catalog #	Size
SS-075-17	18.5 cm (7 1/4")



Sims-Siebold Gynecological Scissor
 Straight

Catalog #	Size
SS-078-24	24.5 cm (9 3/4")



Sims-Siebold Gynecological Scissor
 Straight

SUPER Edge[™]

Catalog #	Size
SS-078-24 SC	24.5 cm (9 3/4")



Gynecological Scissors
Gynäkologische Scheren
Tijeras para ginecología
Ciseaux à gynécologie
Forbici per ginecologia

Sims-Siebold Gynecological Scissor
Curved

Catalog #	Size
SS-079-24	24.5 cm (9 3/4")

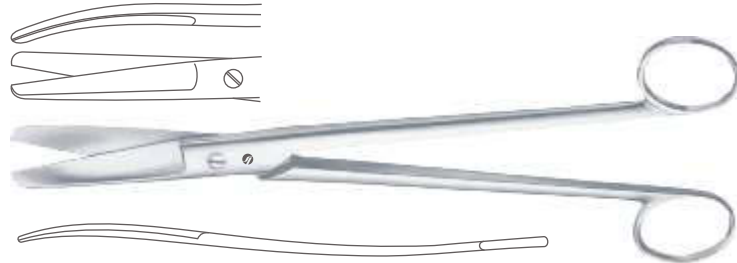

Sims-Siebold Gynecological Scissor
Curved

SUPER Edge™

Catalog #	Size
SS-079-24 SC	24.5 cm (9 3/4")

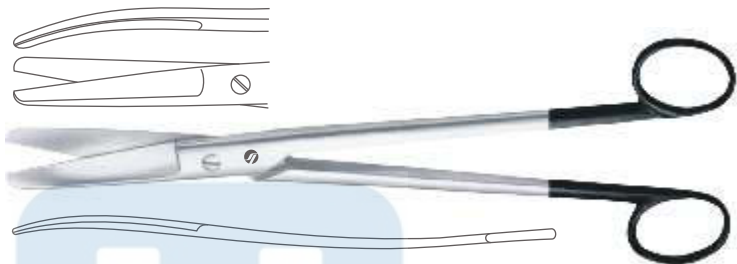

Sims Gynecological Scissor
Straight, Sharp/Sharp

Catalog #	Size
SS-082-20	20 cm (8")

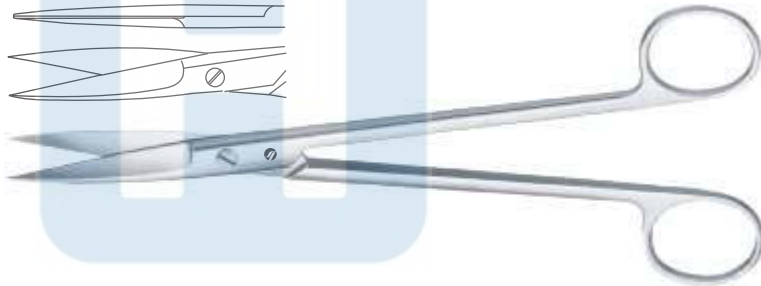

Sims Gynecological Scissor
Curved, Blunt/Blunt

Catalog #	Size
SS-085-21	21 cm (8 1/4")



Wertheim Gynecological Scissor
Curved

Catalog #	Size
SS-087-20	20 cm (8")
SS-087-23	23 cm (9")



Gynecological Scissors, Dissecting Scissors
 Gynäkologische Scheren, Präparierscheren
 Tijeras para ginecología, Tijeras de disección
 Ciseaux à gynécologie, Ciseaux à dissection
 Forbici per ginecologia, Forbici per dissezione

Bozemann Gynecological Scissor
 S Shaped

Catalog #	Size
SS-089-22	22 cm (8 ¾")



Kieback Parametrium Scissor
 Angled 90°

Catalog #	Size
SS-091-24	24 cm (9 ½")
SS-091-35	35 cm (13 ¾")

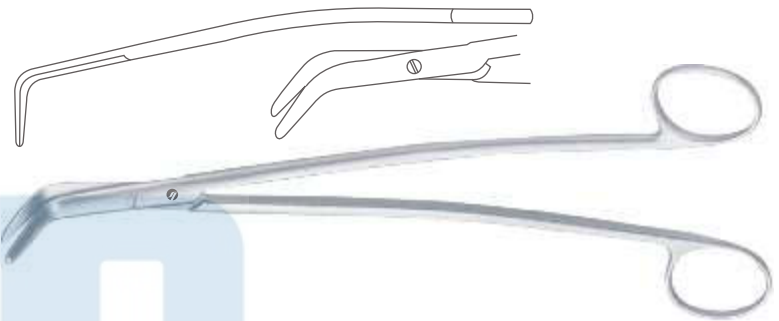

Kieback Parametrium Scissor
 Curved to Side, One Probe Pointed Blade
 One Toothed Cutting Edge

Catalog #	Size
SS-093-26	26 cm (10 ¼")
SS-093-35	35 cm (13 ¾")

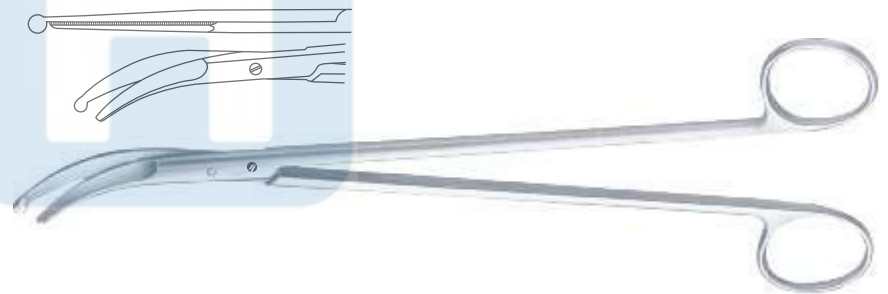

Kelly Dissecting Scissor
 Straight

Catalog #	Size
SS-100-16	16 cm (6 ¼")

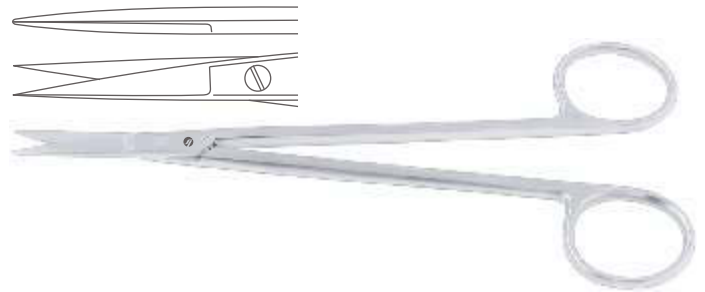

Kelly Dissecting Scissor
 Straight

SUPER Edge™

Catalog #	Size
SS-100-16 SC	16 cm (6 ¼")



Dissecting Scissors
 Präparierscheren
 Tijeras de disección
 Ciseaux à dissection
 Forbici per dissezione

Kelly Dissecting Scissor
 Curved

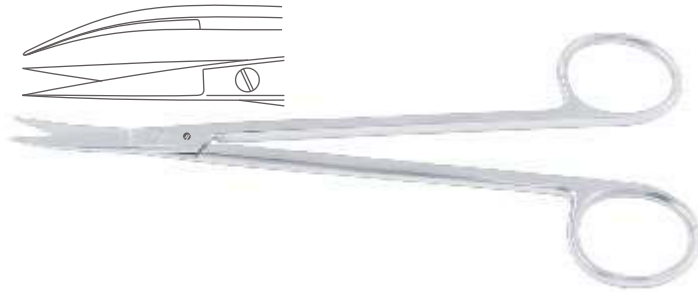

Catalog #	Size
SS-101-16	16 cm (6 1/4")

Kelly Dissecting Scissor
 Curved



SUPER Edge™

Catalog #	Size
SS-101-16 SC	16 cm (6 1/4")

Joseph Dissecting Scissor
 Straight

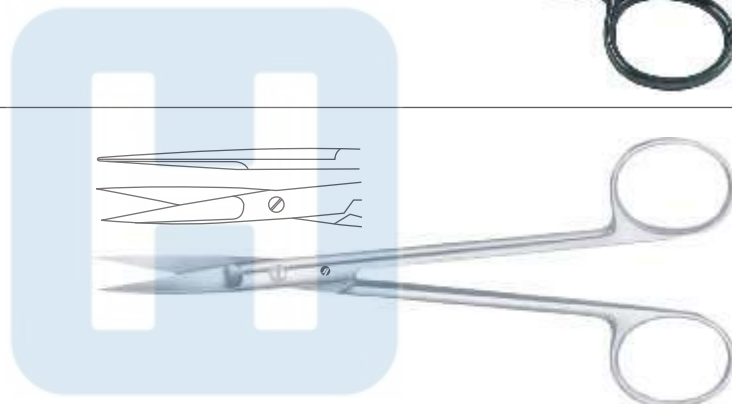

Catalog #	Size
SS-104-15	15 cm (6")

Joseph Dissecting Scissor
 Straight

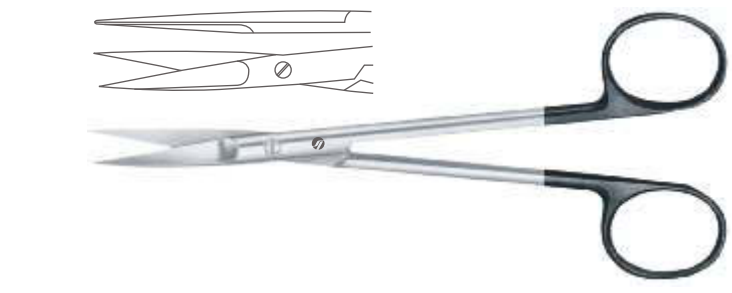

SUPER Edge™

Catalog #	Size
SS-104-15 SC	15 cm (6")

Joseph Dissecting Scissor
 Curved

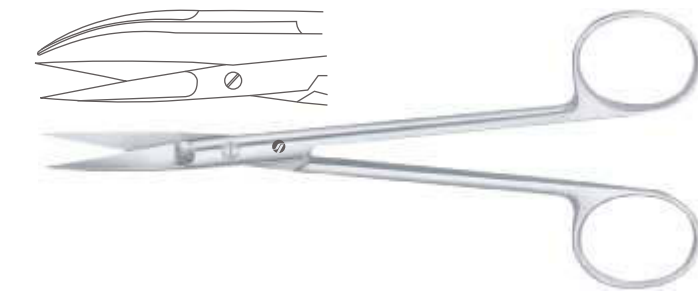

Catalog #	Size
SS-105-15	15 cm (6")

Dissecting Scissors
 Präparierscheren
 Tijeras de disección
 Ciseaux à dissection
 Forbici per dissezione

Joseph Dissecting Scissor
 Curved

SUPER Edge[™]

Catalog #	Size
SS-105-15 SC	15 cm (6")



Weller Dissecting Scissor
 Heavy Pattern

Catalog #	Size
SS-111-28	28 cm (11")



Resano Cartilage Scissor

Catalog #	Size
SS-113-25	25 cm (9 3/4")

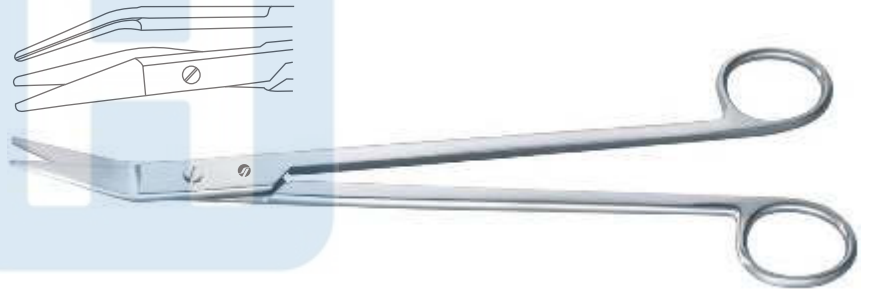

Metzenbaum Dissecting Scissor
 Straight, Blunt/Blunt

Catalog #	Size
SS-120-11	11.5 cm (4 1/2")

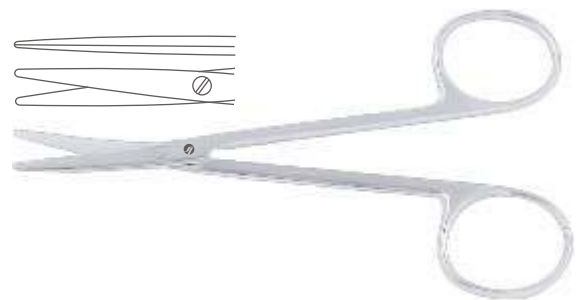

Metzenbaum Dissecting Scissor
 Straight, Blunt/Blunt

SUPER Edge[™]

Catalog #	Size
SS-120-11 SC	11.5 cm (4 1/2")



Dissecting Scissors
 Präparierscheren
 Tijeras de disección
 Ciseaux à dissection
 Forbici per dissezione

Metzenbaum Dissecting Scissor
 Straight, Blunt/Blunt

SUPER Edge™

Catalog #	Size
SS-122-15 SC	15.5 cm (6")



Metzenbaum Dissecting Scissor
 Curved, Blunt/Blunt

Catalog #	Size
SS-123-15	15.5 cm (6")

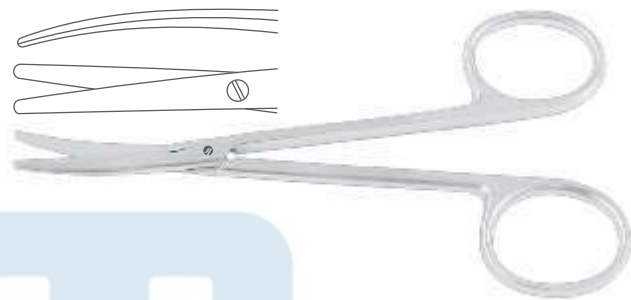

Metzenbaum Dissecting Scissor
 Curved, Blunt/Blunt

SUPER Edge™

Catalog #	Size
SS-123-15 SC	15.5 cm (6")

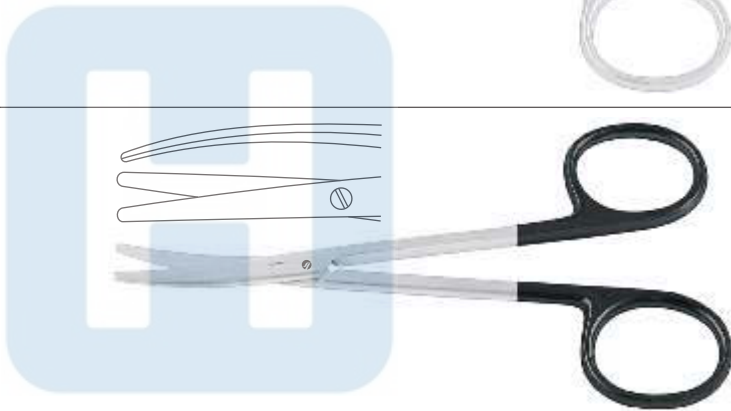

Metzenbaum Dissecting Scissor
 Straight, Blunt/Blunt

Catalog #	Size
SS-130-14	14.5 cm (5 3/4")



Metzenbaum Dissecting Scissor
 Straight, Blunt/Blunt

SUPER Edge™

Catalog #	Size
SS-130-14 SC	14.5 cm (5 3/4")



Dissecting Scissors
 Präparierscheren
 Tijeras de disección
 Ciseaux à dissection
 Forbici per dissezione

Metzenbaum Dissecting Scissor
 Curved, Blunt/Blunt

Catalog #	Size
SS-121-11	11.5 cm (4 1/2")

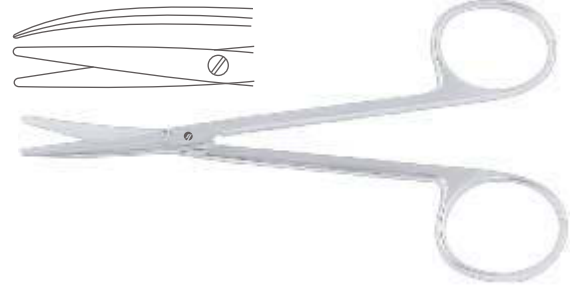

Metzenbaum Dissecting Scissor
 Curved, Blunt/Blunt

SUPER Edge™

Catalog #	Size
SS-121-11 SC	11.5 cm (4 1/2")

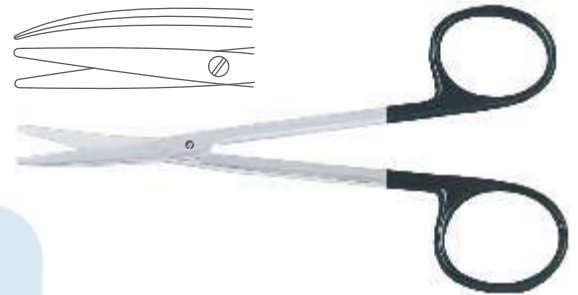

Metzenbaum Dissecting Scissor
 Straight, Blunt/Blunt

Catalog #	Size
SS-122-15	15.5 cm (6")



Metzenbaum Dissecting Scissor
 Curved, Blunt/Blunt

Catalog #	Size
SS-131-14	14.5 cm (5 3/4")



Metzenbaum Dissecting Scissor
 Curved, Blunt/Blunt

SUPER Edge™

Catalog #	Size
SS-131-14 SC	14.5 cm (5 3/4")



INCHES
 MILLIMETERS

Dissecting Scissors
 Präparierscheren
 Tijeras de disección
 Ciseaux à dissection
 Forbici per dissezione

Metzenbaum Dissecting Scissor
 Straight, Sharp/Blunt

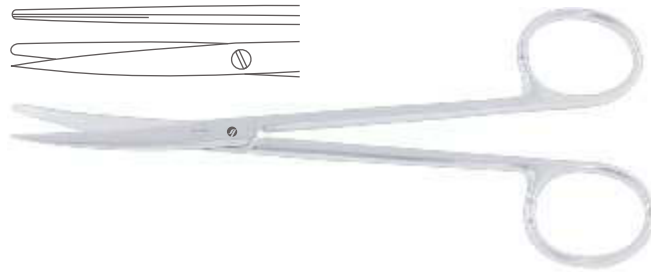

Catalog #	Size
SS-132-14	14.5 cm (5 ¾")

Metzenbaum Dissecting Scissor
 Curved, Sharp/Blunt

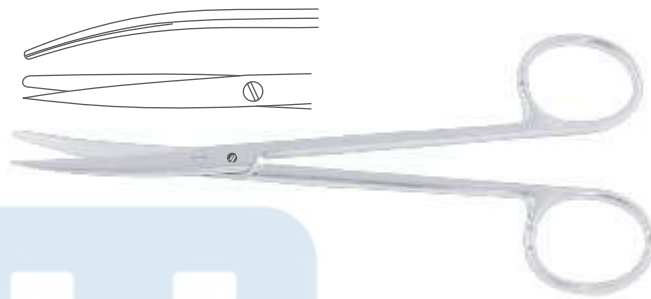

Catalog #	Size
SS-133-14	14.5 cm (5 ¾")

Metzenbaum Dissecting Scissor
 Straight, Sharp/Sharp

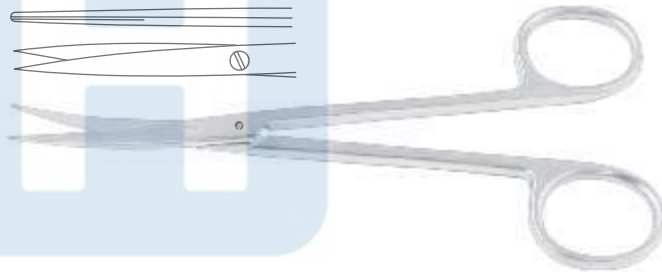

Catalog #	Size
SS-134-14	14.5 cm (5 ¾")

Metzenbaum Dissecting Scissor
 Curved, Sharp/Sharp



Catalog #	Size
SS-135-14	14.5 cm (5 ¾")

Dissecting Scissors
 Präparierscheren
 Tijeras de disección
 Ciseaux à dissection
 Forbici per dissezione

Metzenbaum-Nelson Dissecting Scissor
 Straight, Blunt/Blunt

Catalog #	Size
SS-140-18	18 cm (7")
SS-140-20	20.5 cm (8")
SS-140-23	23 cm (9")
SS-140-26	26 cm (10 ¼")
SS-140-28	28.5 cm (11 ¼")
SS-140-30	31 cm (12 ¼")

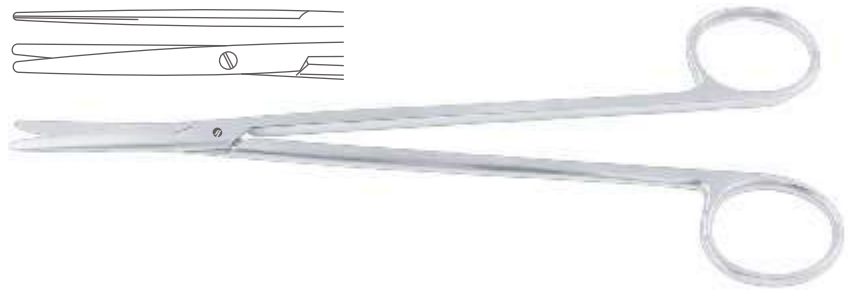
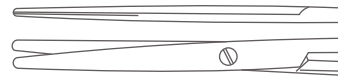

Metzenbaum-Nelson Dissecting Scissor
 Straight, Blunt/Blunt

SUPER Edge™

Catalog #	Size
SS-140-18 SC	18 cm (7")
SS-140-20 SC	20.5 cm (8")
SS-140-23 SC	23 cm (9")
SS-140-26 SC	26 cm (10 ¼")

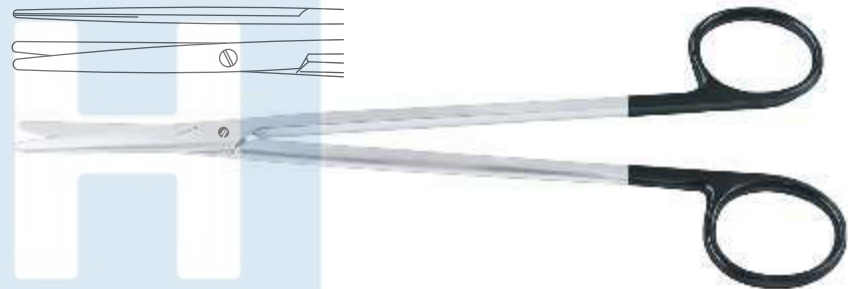

Metzenbaum-Nelson Dissecting Scissor
 Curved, Blunt/Blunt

Catalog #	Size
SS-141-18	18 cm (7")
SS-141-20	20.5 cm (8")
SS-141-23	23 cm (9")
SS-141-26	26 cm (10 ¼")
SS-141-28	28.5 cm (11 ¼")
SS-141-30	31 cm (12 ¼")

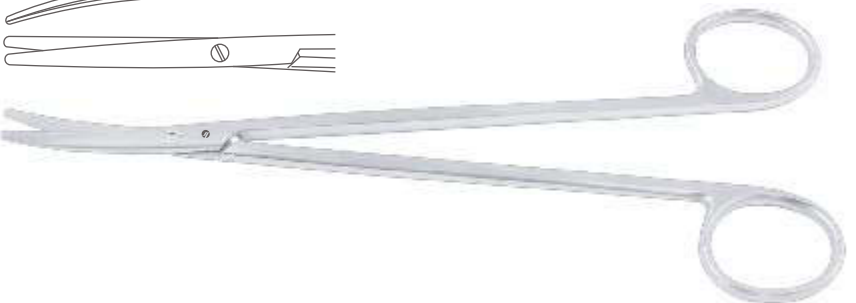
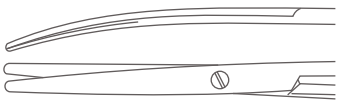

Dissecting Scissors
 Präparierscheren
 Tijeras de disección
 Ciseaux à dissection
 Forbici per dissezione

SS

SCISSORS

Metzenbaum-Nelson Dissecting Scissor
 Curved, Blunt/Blunt

SUPER Edge™

Catalog #	Size
SS-141-18 SC	18 cm (7")
SS-141-20 SC	20.5 cm (8")
SS-141-23 SC	23 cm (9")
SS-141-26 SC	26 cm (10 ¼")



Metzenbaum-Nelson Dissecting Scissor
 Straight, Sharp/Sharp

Catalog #	Size
SS-144-18	18 cm (7")
SS-144-20	20.5 cm (8")

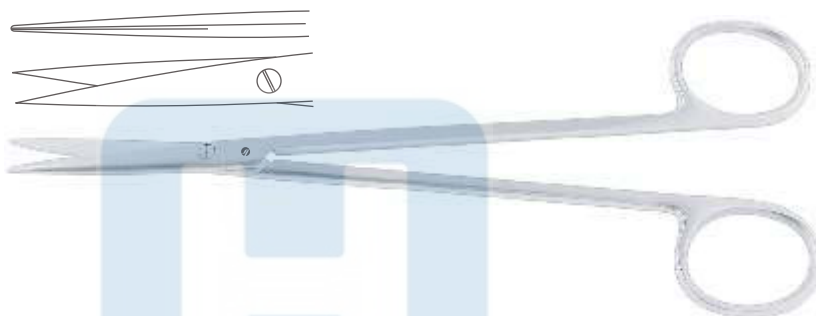

Metzenbaum Dissecting Scissor
 Straight, Sharp/Sharp, Toothed

Catalog #	Size
SS-146-14	14.5 cm (5 ¾")

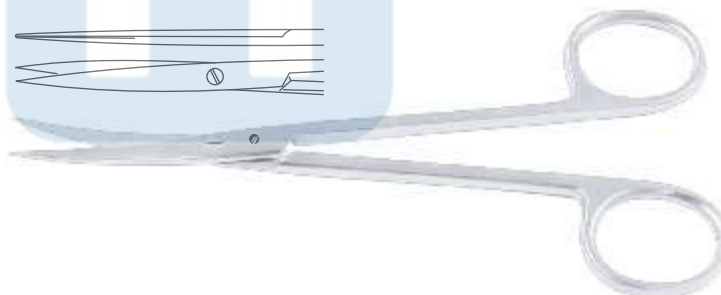

Metzenbaum Dissecting Scissor
 Curved, Sharp/Sharp, Toothed

Catalog #	Size
SS-147-14	14.5 cm (5 ¾")

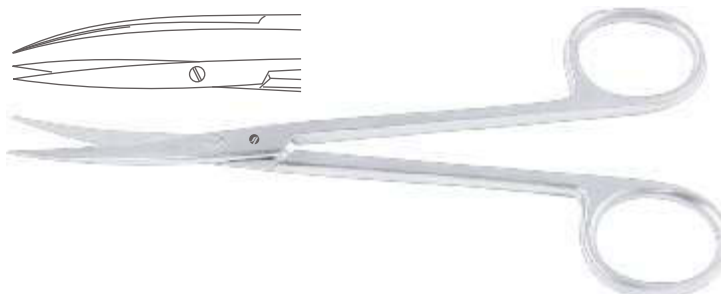

Dissecting Scissors, Face-lift Scissors
 Präparierscheren, Face-lift-Scheren
 Tijeras de disección, Tijeras para Face-Lift
 Ciseaux à dissection, Ciseaux pour Face-lift
 Forbici per dissezione, Forbici per Face-lift

Metzenbaum Nerve Dissecting Scissor
 Straight



Catalog #	Size
SS-148-15	15.5 cm (6")

Metzenbaum Nerve Dissecting Scissor
 Curved

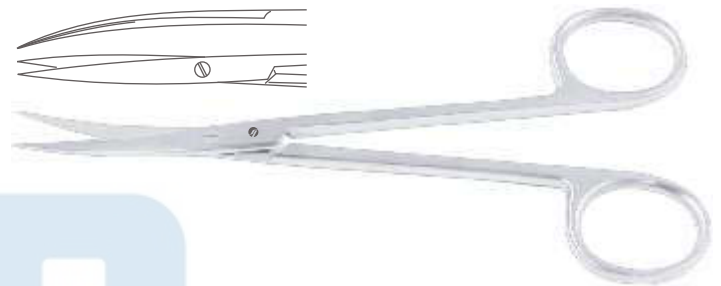

Catalog #	Size
SS-149-15	15.5 cm (6")

McIndoe Cartilage Scissor
 Straight, Toothed

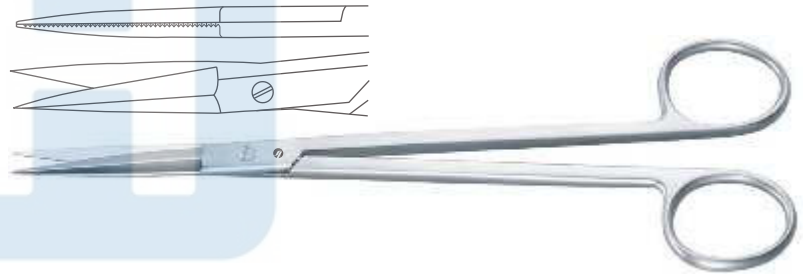

Catalog #	Size
SS-154-18	18.5 cm (7 1/4")

McIndoe Cartilage Scissor
 Curved, Toothed



Catalog #	Size
SS-155-18	18.5 cm (7 1/4")

Kaye Face-Lift Scissor
 Curved



SUPER Edge™

Catalog #	Size
SS-161-18 SC	18.5 cm (7 1/4")

Face-lift Scissors, Dissecting Scissors
 Face-lift-Scheren, Präparierscheren
 Tijeras para Face-Lift, Tijeras de disección
 Ciseaux pour Face-lift, Ciseaux à dissection
 Forbici per Face-lift, Forbici per dissezione

Gorney Face-Lift Scissor
 Straight

SUPER Edge™

Catalog #	Size
SS-166-12 SC	12.5 cm (5")
SS-166-19 SC	19.5 cm (7 ¾")



Gorney Face-Lift Scissor
 Curved

SUPER Edge™

Catalog #	Size
SS-167-19 SC	19.5 cm (7 ¾")



Aston Face-Lift Scissor
 Straight

SUPER Edge™

Catalog #	Size
SS-170-17 SC	17 cm (6 ¾")



Lexer Dissecting Scissor
 Straight

Catalog #	Size
SS-176-16	16 cm (6 ¼")



Lexer Dissecting Scissor
 Straight

SUPER Edge™

Catalog #	Size
SS-176-16 SC	16 cm (6 ¼")



Dissecting Scissors, Nasal Scissors
 Präparierscheren, Nasenscheren
 Tijeras de disección, Tijeras nasales
 Ciseaux à dissection, Ciseaux nasaux
 Forbici per dissezione, Forbici nasali

Lexer Dissecting Scissor
 Curved



Catalog #	Size
SS-177-16	16 cm (6 ¼")

Lexer Dissecting Scissor
 Curved



SUPER Edge™

Catalog #	Size
SS-177-16 SC	16 cm (6 ¼")

Cottle-Masing Plastic Surgery Scissor
 Curved, Sharp/Sharp

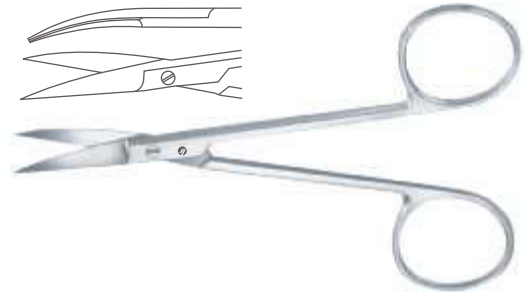

Catalog #	Size
SS-181-10	10.5 cm (4 ¼")

Cottle-Masing Plastic Surgery Scissor
 Curved, Blunt/Blunt

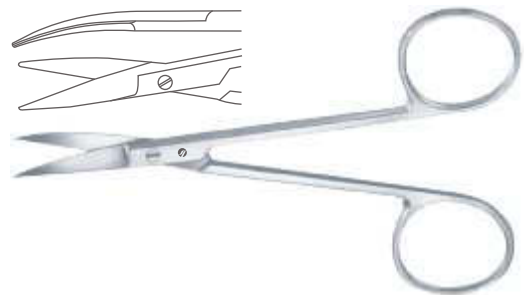

Catalog #	Size
SS-183-10	10.5 cm (4 ¼")

Cinelli Nasal Scissor
 Curved



Catalog #	Size
SS-187-11	11.5 cm (4 ½")

INCHES
 MILLIMETERS

Nasal Scissors, Delicate Dissecting Scissors
 Nasenscheren, Feine Präparierscheren
 Tijeras nasales, Tijeras finas de disección
 Ciseaux nasaux, Ciseaux fins à dissection
 Forbici nasali, Forbici fini per dissezione

Fomon Nasal Scissor
 Curved

Catalog #	Size
SS-189-14	14 cm (5 1/2")



Thorek Dissecting Scissor
 Curved

Catalog #	Size
SS-191-19	18.5 cm (7 1/4")



Lexer-Baby Dissecting Scissor
 Straight

Catalog #	Size
SS-194-10	10 cm (4")

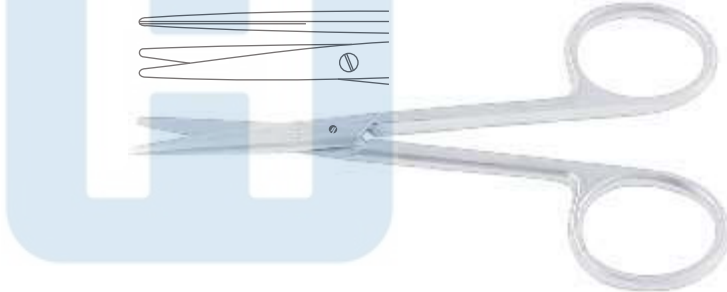

Lexer-Baby Dissecting Scissor
 Curved

Catalog #	Size
SS-195-10	10 cm (4")

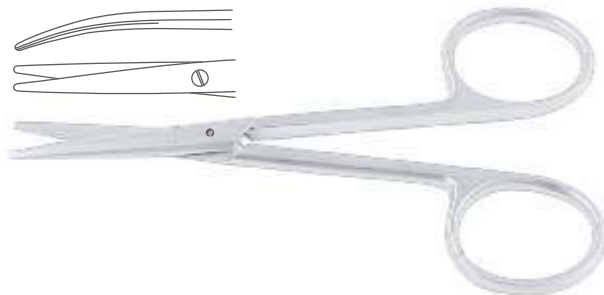

Lexer-Fine Delicate Dissecting Scissor
 Straight, Slender Pattern

Catalog #	Size
SS-196-16	16.5 cm (6 1/2")

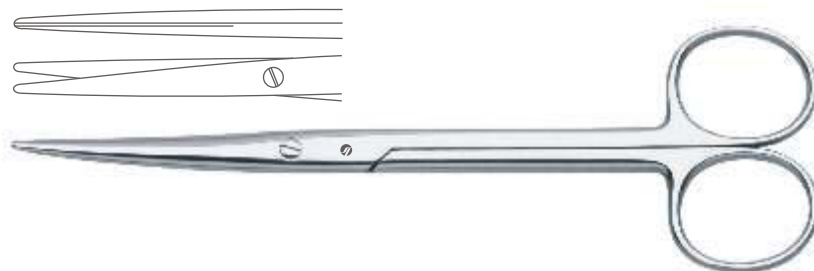

Delicate Dissecting Scissors
 Feine Präparierscheren
 Tijeras finas de disección
 Ciseaux fins à dissection
 Forbici fini per dissezione

Lexer-Fine Delicate Dissecting Scissor
 Curved, Slender Pattern



Catalog #	Size
SS-197-16	16.5 cm (6 1/2")

Metzenbaum-Fine Delicate Dissecting Scissor
 Straight, Blunt/Blunt, Slender Pattern



Catalog #	Size
SS-200-14	14.5 cm (5 3/4")

Metzenbaum-Fine Delicate Dissecting Scissor
 Straight, Blunt/Blunt, Slender Pattern



SUPER Edge™

Catalog #	Size
SS-200-14 SC	14.5 cm (5 3/4")

Metzenbaum-Fine Delicate Dissecting Scissor
 Curved, Blunt/Blunt, Slender Pattern

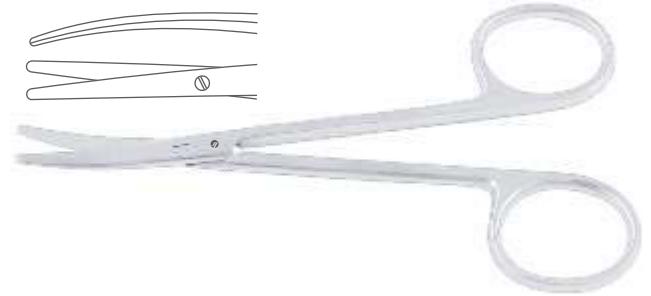

Catalog #	Size
SS-201-14	14.5 cm (5 3/4")

Metzenbaum-Fine Delicate Dissecting Scissor
 Curved, Blunt/Blunt, Slender Pattern



SUPER Edge™

Catalog #	Size
SS-201-14 SC	14.5 cm (5 3/4")

Delicate Dissecting Scissors
 Feine Präparierscheren
 Tijeras finas de disección
 Ciseaux fins à dissection
 Forbici fini per dissezione

Metzenbaum-Fine Delicate Dissecting Scissor
 Straight, Sharp/Sharp, Slender Pattern

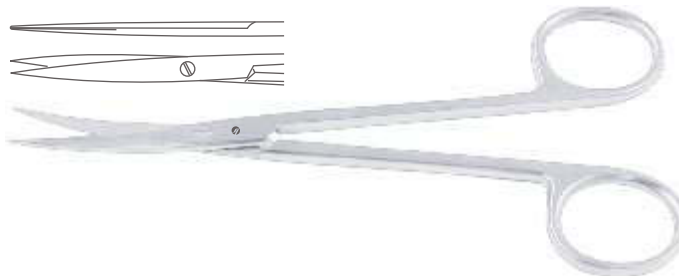

Catalog #	Size
SS-202-14	14.5 cm (5 3/4")

Metzenbaum-Fine Delicate Dissecting Scissor
 Curved, Sharp/Sharp, Slender Pattern

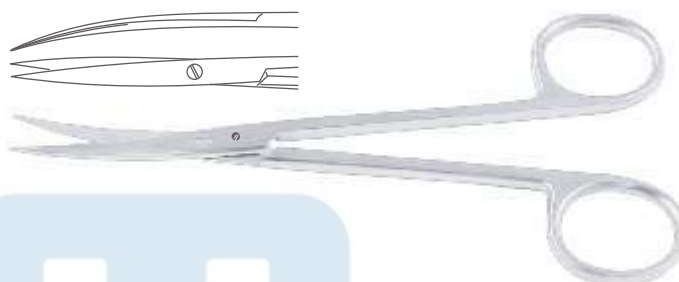

Catalog #	Size
SS-203-16	14.5 cm (5 3/4")

Metzenbaum-Fine Delicate Dissecting Scissor
 Straight, Blunt/Blunt, Slender Pattern

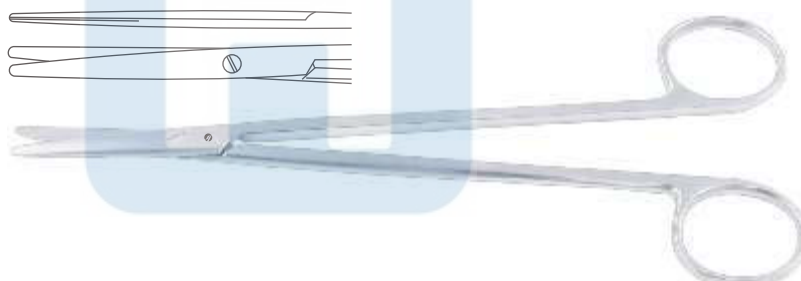

Catalog #	Size
SS-210-18	18 cm (7")
SS-210-20	20 cm (8")
SS-210-23	23 cm (9")

Metzenbaum-Fine Delicate Dissecting Scissor
 Straight, Blunt/Blunt, Slender Pattern

SUPER Edge™

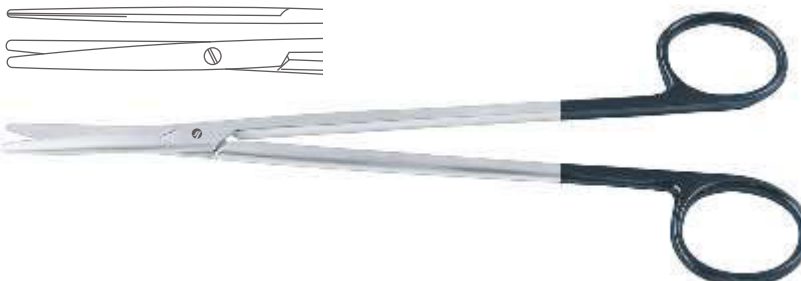

Catalog #	Size
SS-210-18 SC	18 cm (7")
SS-210-20 SC	20 cm (8")
SS-210-23 SC	23 cm (9")

Delicate Dissecting Scissors, Dissecting Scissors
 Feine Präparierscheren, Präparierscheren
 Tijeras finas de disección, Tijeras de disección
 Ciseaux fins à dissection, Ciseaux à dissection
 Forbici fini per dissezione, Forbici per dissezione

Metzenbaum-Fine Delicate Dissecting Scissor
 Curved, Blunt/Blunt, Slender Pattern

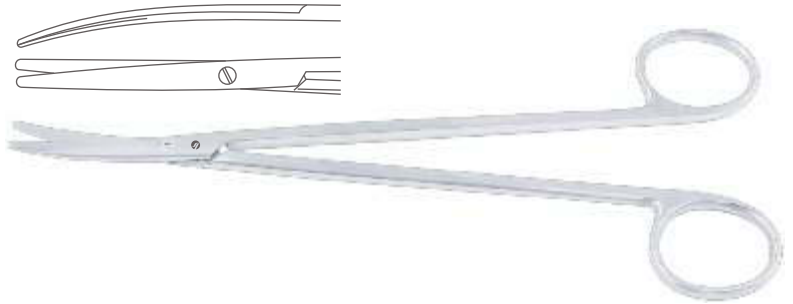

Catalog #	Size
SS-211-18	18 cm (7")
SS-211-20	20 cm (8")
SS-211-23	23 cm (9")

Metzenbaum-Fine Delicate Dissecting Scissor
 Curved, Blunt/Blunt, Slender Pattern

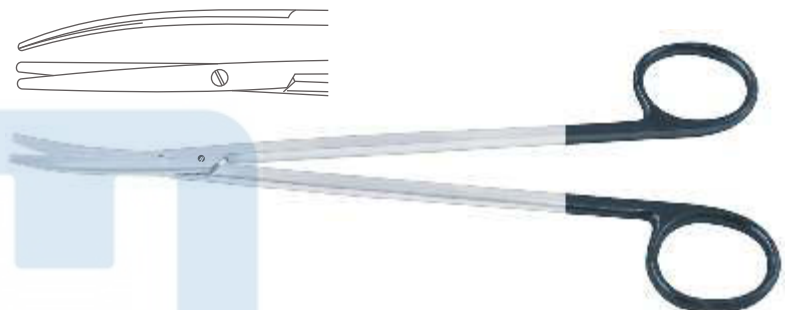

SUPER Edge™

Catalog #	Size
SS-211-18 SC	18 cm (7")
SS-211-20 SC	20 cm (8")
SS-211-23 SC	23 cm (9")

Metzenbaum-Fine Delicate Dissecting Scissor
 Straight, Sharp/Sharp, Slender Pattern



Catalog #	Size
SS-214-18	18 cm (7")
SS-214-20	20 cm (8")
SS-214-23	23 cm (9")

Metzenbaum-Fine Delicate Dissecting Scissor
 Straight, Sharp/Sharp, Slender Pattern



SUPER Edge™

Catalog #	Size
SS-214-18 SC	18 cm (7")
SS-214-20 SC	20 cm (8")
SS-214-23 SC	23 cm (9")

Delicate Dissecting Scissors, Dissecting Scissors
 Feine Präparierscheren, Präparierscheren
 Tijeras finas de disección, Tijeras de disección
 Ciseaux fins à dissection, Ciseaux à dissection
 Forbici fini per dissezione, Forbici per dissezione

Metzenbaum-Fine Delicate Dissecting Scissor
 Curved, Sharp/Sharp, Slender Pattern

Catalog #	Size
SS-215-18	18 cm (7")
SS-215-20	20 cm (8")
SS-215-23	23 cm (9")



Metzenbaum-Fine Delicate Dissecting Scissor
 Curved, Sharp/Sharp, Slender Pattern

SUPER Edge™

Catalog #	Size
SS-215-18 SC	18 cm (7")
SS-215-20 SC	20 cm (8")
SS-215-23 SC	23 cm (9")



Metzenbaum-Fine Delicate Dissecting Scissor
 Curved, S Shaped

Catalog #	Size
SS-219-18	18 cm (7")
SS-219-20	20 cm (8")
SS-219-23	23 cm (9")

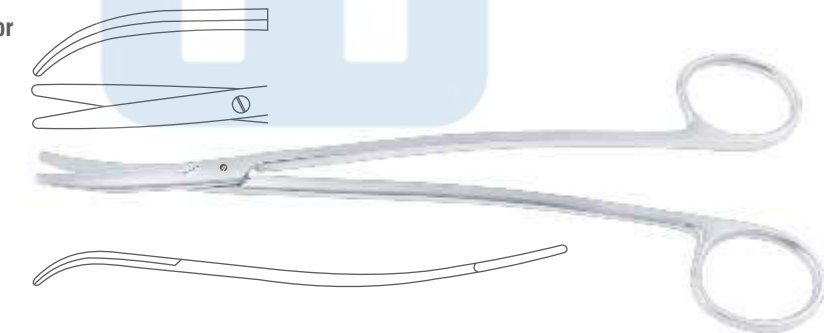

Salzer Cleft Palate Dissecting Scissor
 Curved, Fine Pattern

Catalog #	Size
SS-223-12	12.5 cm (5")
SS-223-18	18 cm (7")



Dissecting Scissors, Face-lift Scissors
 Präparierscheren, Face-lift-Scheren
 Tijeras de disección, Tijeras para Face-Lift
 Ciseaux à dissection, Ciseaux pour Face-lift
 Forbici per dissezione, Forbici per Face-lift

Sanvenero Dissecting Scissor
 Straight



Catalog #	Size
SS-226-14	14 cm (5 1/2")

Sanvenero Dissecting Scissor
 Curved



Catalog #	Size
SS-227-14	14 cm (5 1/2")

Tenotomy Scissor
 Straight



Catalog #	Size
SS-230-11	11.5 cm (4 1/2")

Tenotomy Scissor
 Curved

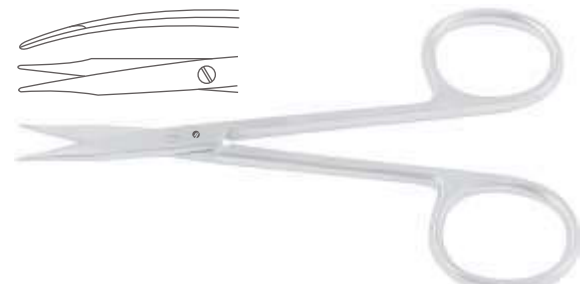

Catalog #	Size
SS-231-11	11.5 cm (4 1/2")

Peck-Joseph Face-Lift Scissor
 Straight, Sharp/Sharp

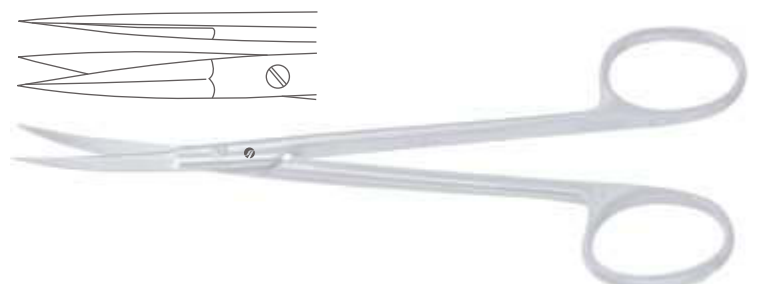

Catalog #	Size
SS-236-14	14.5 cm (5 3/4")

Face-lift Scissors, Dissecting Scissors
 Face-lift-Scheren, Präparierscheren
 Tijeras para Face-Lift, Tijeras de disección
 Ciseaux pour Face-lift, Ciseaux à dissection
 Forbici per Face-lift, Forbici per dissezione

Peck-Joseph Face-Lift Scissor
 Curved, Sharp/Sharp

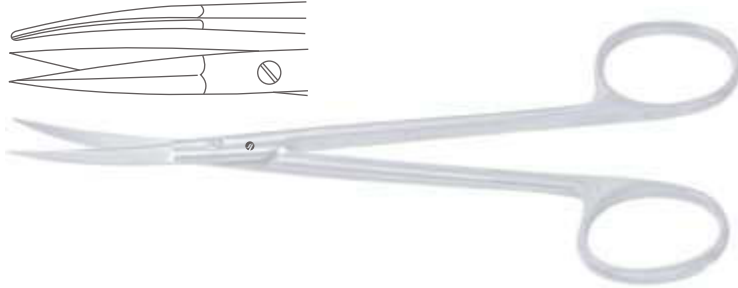

Catalog #	Size
SS-237-14	14.5 cm (5 ¾")

Peck-Joseph Face-Lift Scissor
 Straight, Blunt/Blunt



Catalog #	Size
SS-238-14	14.5 cm (5 ¾")

Peck-Joseph Face-Lift Scissor
 Curved, Blunt/Blunt



Catalog #	Size
SS-239-14	14.5 cm (5 ¾")

Shea Vein Graft Scissor
 Curved

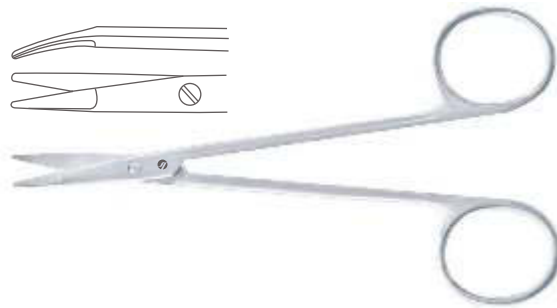

Catalog #	Size
SS-241-12	12 cm (4 ¾")

Ragnell (Kilner) Dissecting Scissor
 Curved



Catalog #	Size
SS-243-12	12 cm (4 ¾")
SS-243-15	15 cm (6")
SS-243-18	18 cm (7")

Dissecting Scissors
 Präparierscheren
 Tijeras de disección
 Ciseaux à dissection
 Forbici per dissezione

Nerve Dissecting Scissor
 Curved, Semi Sharp

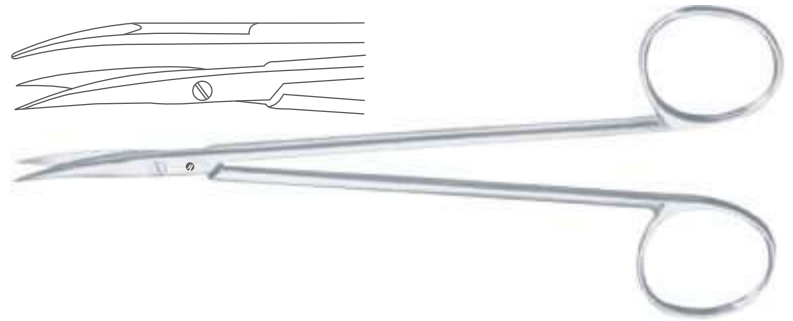

Catalog #	Size
SS-245-15	15 cm (6")

Dissecting Scissor
 Straight

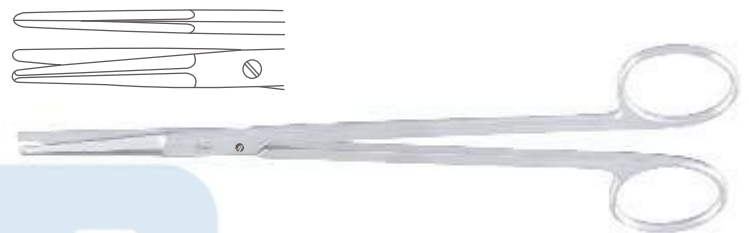

Catalog #	Size
SS-248-14	14.5 cm (5 3/4")

Dissecting Scissor
 Curved

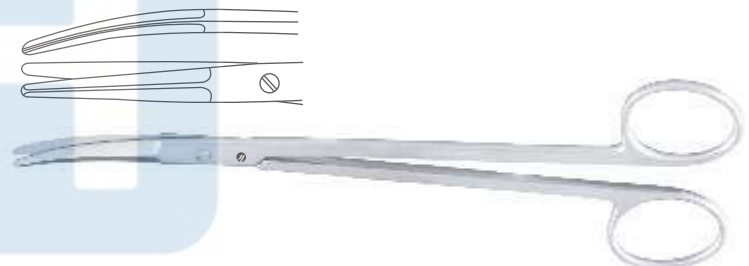

Catalog #	Size
SS-249-14	14.5 cm (5 3/4")

Reynolds Dissecting Scissor
 Straight

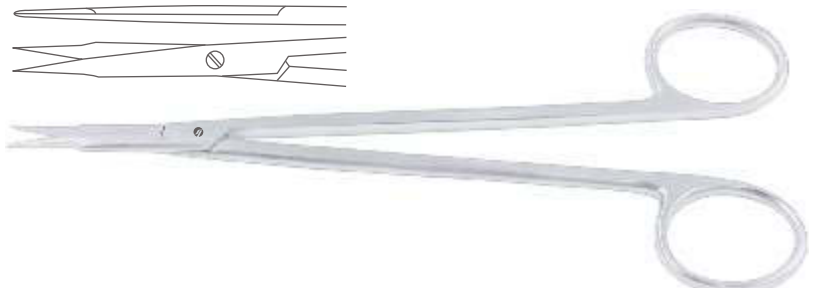

Catalog #	Size
SS-250-15	15.5 cm (6")
SS-250-18	18 cm (7")

Reynolds Dissecting Scissor
 Straight

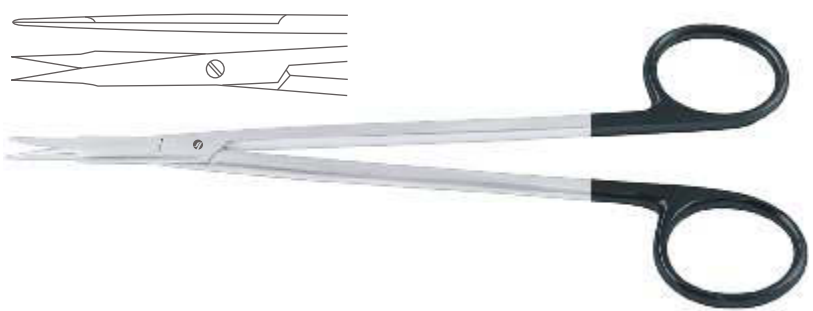

SUPER Edge™

Catalog #	Size
SS-250-15 SC	15.5 cm (6")
SS-250-18 SC	18 cm (7")

Dissecting Scissors
 Präparierscheren
 Tijeras de disección
 Ciseaux à dissection
 Forbici per dissezione

Reynolds Dissecting Scissor
 Curved

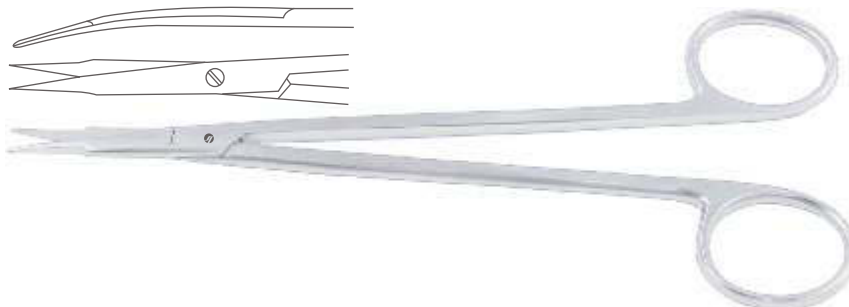

Catalog #	Size
SS-251-15	15.5 cm (6")
SS-251-18	18 cm (7")

Reynolds Dissecting Scissor
 Curved

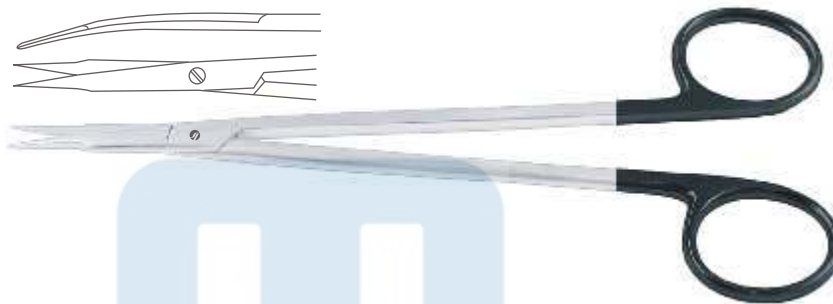

Catalog #	Size
SS-251-15 SC	15.5 cm (6")
SS-251-18 SC	18 cm (7")

Jameson Dissecting Scissor
 Curved

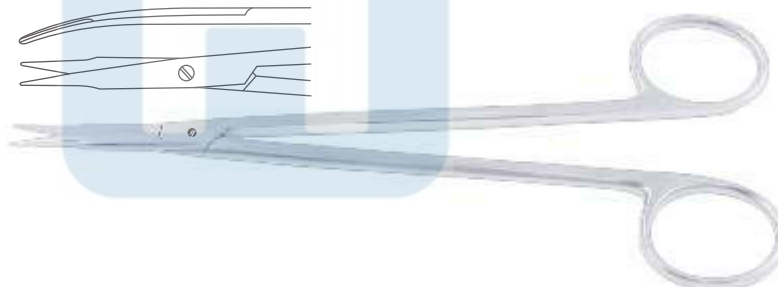

Catalog #	Size
SS-253-15	15.5 cm (6")

Jameson Dissecting Scissor
 Curved



SUPER Edge™

Catalog #	Size
SS-253-15 SC	15.5 cm (6")

Jameson-Werber Dissecting Scissor
 Curved

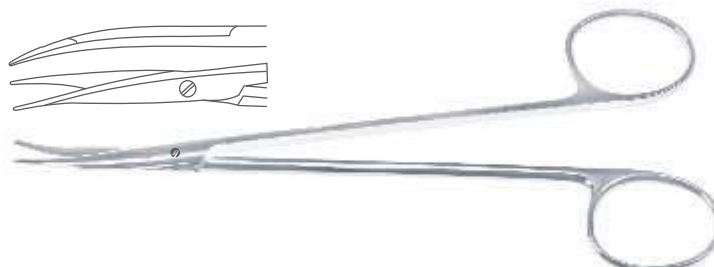

Catalog #	Size
SS-257-13	13 cm (5")

Dissecting Scissors, Vascular Scissors
 Präparierscheren, Gefäßscheren
 Tijeras de disección, Tijeras vasculares
 Ciseaux à dissection, Ciseaux vasculaires
 Forbici per dissezione, Forbici vascolari

Potts Dissecting Scissor
 Curved

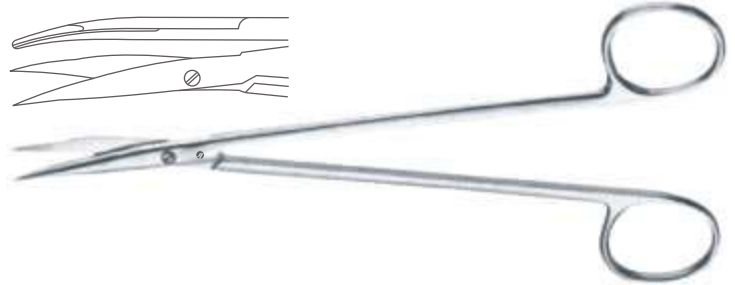

Catalog #	Size
SS-259-18	18 cm (7")

DeBakey Arteriotomy Scissor
 Curved

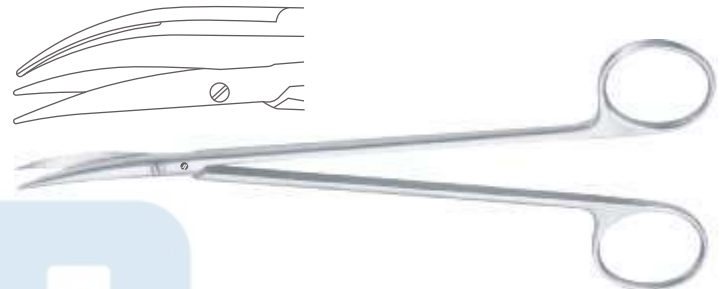

Catalog #	Size
SS-261-17	17.5 cm (7")

Vascular Scissor
 Straight

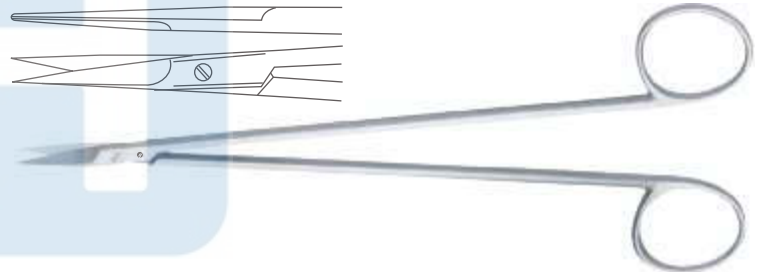

Catalog #	Size
SS-264-19	19 cm (7 1/2")

Vascular Scissor
 Curved

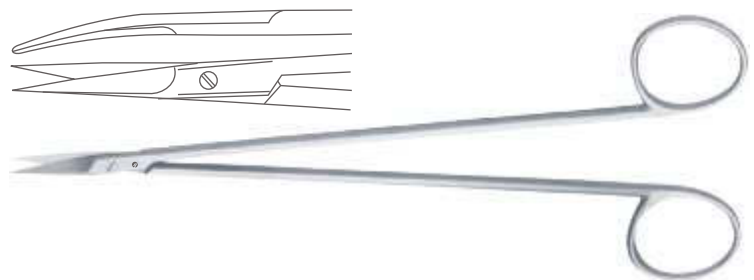

Catalog #	Size
SS-265-19	19 cm (7 1/2")

Satinsky Thoracic Scissor
 Curved

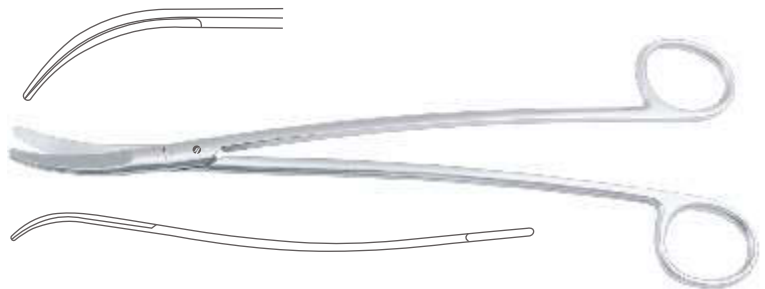

Catalog #	Size
SS-267-24	25.5 cm (10")

Vascular Scissors
Gefäßscheren
Tijeras vasculares
Ciseaux vasculaires
Forbici vascolari

SS

SCISSORS

Diethrich-Salyer Cleft Palate Dissecting Scissor
Angled

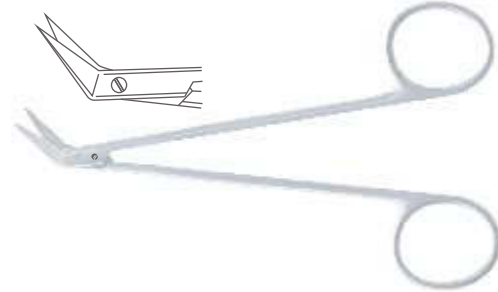

Catalog #	Size
SS-269-12	12 cm (4 ¾")

Diethrich Vascular Scissor
Angled 125°, With Guide



Catalog #	Size
SS-275-00	17.5 cm (7")

DeBakey Vascular Scissor
Angled 45°



Catalog #	Size
SS-277-45	16.5 cm (6 ½")

DeBakey Vascular Scissor
Angled 60°



Catalog #	Size
SS-277-60	16cm (6 ¼")

Potts-Smith Vascular Scissor
Angled 60°, With Probe Tip



Catalog #	Size
SS-279-19	18 cm (7")

Vascular Scissors
 Gefäßscheren
 Tijeras vasculares
 Ciseaux vasculaires
 Forbici vascolari

Potts-Smith Vascular Scissor
 Angled 25°

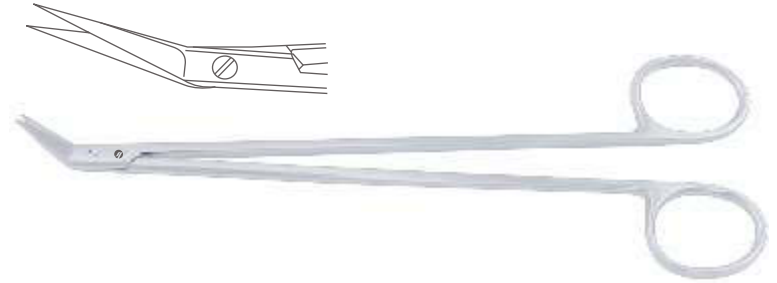

Catalog #	Size
SS-281-25	18 cm (7")

Potts-Smith Vascular Scissor
 Angled 25°

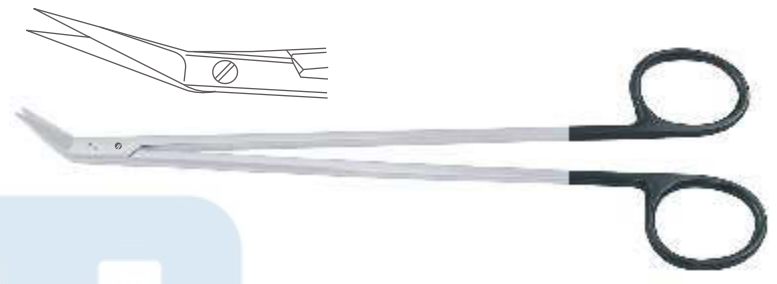

Catalog #	Size
SS-281-25 SC	18 cm (7")

Potts-Smith Vascular Scissor
 Angled 45°



Catalog #	Size
SS-281-45	18.5 cm (7 1/4")

Potts-Smith Vascular Scissor
 Angled 45°

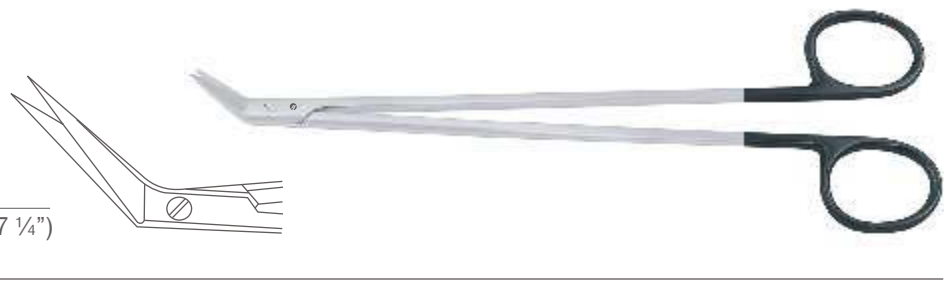

Catalog #	Size
SS-281-45 SC	18.5 cm (7 1/4")

Potts-Smith Vascular Scissor
 Angled 60°



Catalog #	Size
SS-281-60	18 cm (7")

INCHES
 MILLIMETERS

Vascular Scissors
Gefäßscheren
Tijeras vasculares
Ciseaux vasculaires
Forbici vascolari

SS

SCISSORS

Potts-Smith Vascular Scissor
Angled 60°

Catalog #	Size
SS-281-60 SC	18 cm (7")



Potts-Smith Vascular Scissor
Angled on Flat

Catalog #	Size
SS-283-19	18.5 cm (7 1/4")



Vascular Scissors
 Gefäßscheren
 Tijeras vasculares
 Ciseaux vasculaires
 Forbici vascolari

Diethrich-Potts Vascular Scissor
 Standard Blade



Catalog #	Size, Profile
SS-285-25	18 cm (7"), Angled 25°
SS-285-45	18 cm (7"), Angled 45°
SS-285-60	18 cm (7"), Angled 60°
SS-285-90	18 cm (7"), Angled 90°
SS-287-00	18 cm (7"), Angled 125°

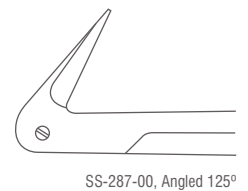
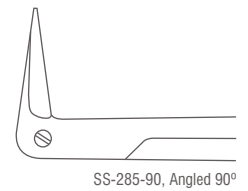
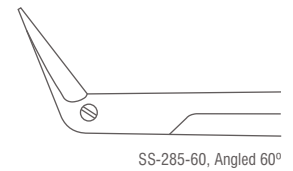
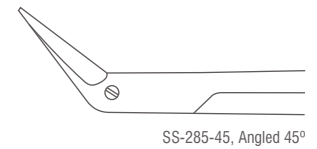
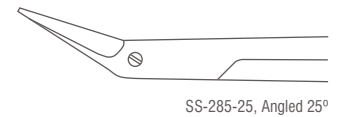

INCHES
 MILLIMETERS

Vascular Scissors
 Gefäßscheren
 Tijeras vasculares
 Ciseaux vasculaires
 Forbici vascolari

Diethrich-Potts Vascular Scissor
 Delicate Blade



Catalog #	Size, Profile
SS-289-25	18 cm (7"), Angled 25°
SS-289-45	18 cm (7"), Angled 45°
SS-289-60	18 cm (7"), Angled 60°
SS-289-90	18 cm (7"), Angled 90°
SS-291-00	18 cm (7"), Angled 125°

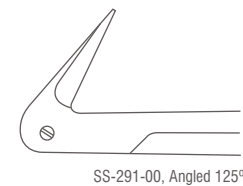
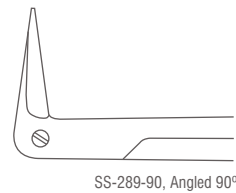
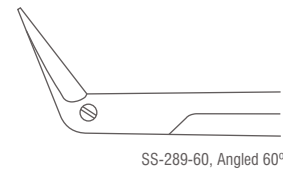
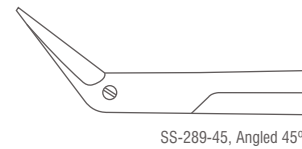
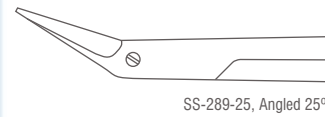

Vascular Scissors
 Gefäßscheren
 Tijeras vasculares
 Ciseaux vasculaires
 Forbici vascolari

Diethrich-Potts Vascular Scissor
 Ultra Delicate Blade

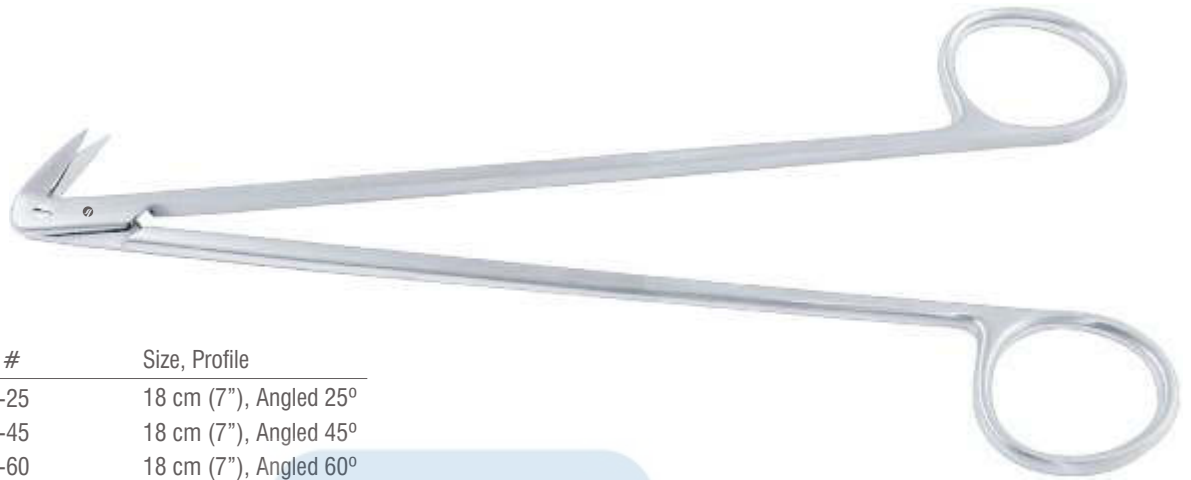

Catalog #	Size, Profile
SS-293-25	18 cm (7"), Angled 25°
SS-293-45	18 cm (7"), Angled 45°
SS-293-60	18 cm (7"), Angled 60°
SS-293-90	18 cm (7"), Angled 90°
SS-295-00	18 cm (7"), Angled 125°

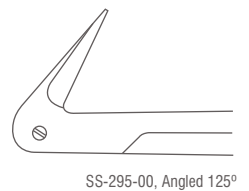
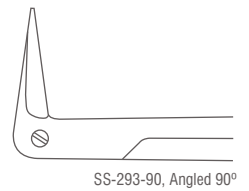
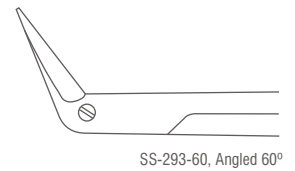
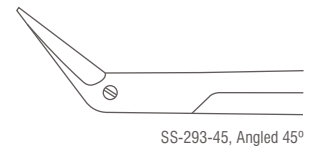
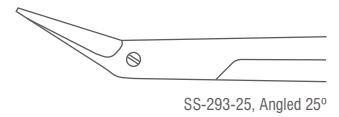

Vascular Scissors
Gefäßscheren
Tijeras vasculares
Ciseaux vasculaires
Forbici vascolari

SS

SCISSORS

Potts-De Martel Cardiovascular Scissor
Angled 60°



Catalog #	Size
SS-299-22	22 cm (8 3/4")

DeBakey Offset Scissor
S Shaped



Catalog #	Size
SS-301-16	15.5 cm (6")

Favaloro Offset Scissor
Angled



Catalog #	Size
SS-303-15	15 cm (6")

Vascular Scissor
One Blade Probe

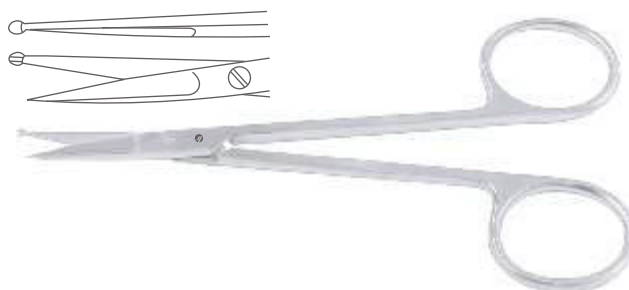

Catalog #	Size
SS-306-12	12 cm (4 3/4")

Vascular Scissor
One Blade Probe

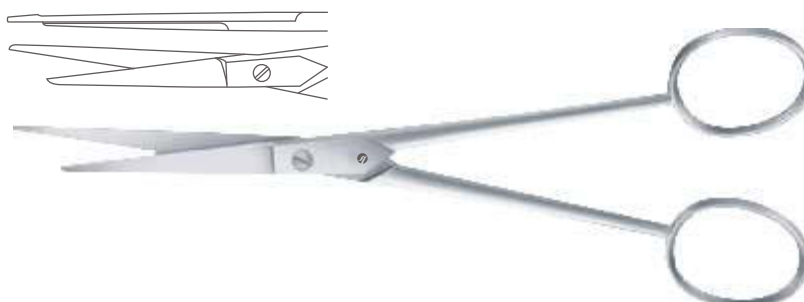

Catalog #	Size
SS-308-14	14.5 cm (5 3/4")

Vascular Scissors
 Gefäßscheren
 Tijeras vasculares
 Ciseaux vasculaires
 Forbici vascolari

Strully Vascular Scissor
 Curved

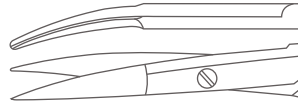

Catalog #	Size
SS-311-22	22 cm (8 3/4")

Vascular Scissor
 Straight

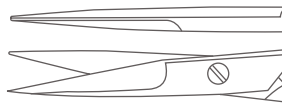

Catalog #	Size
SS-312-22	22.5 cm (8 3/4")

Barre Vascular Scissor
 Straight

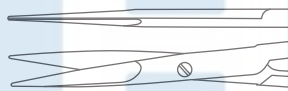

Catalog #	Size
SS-314-28	28 cm (11")

Potts-Smith Vascular Scissor
 Curved

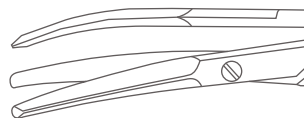

Catalog #	Size
SS-315-19	19 cm (7 1/2")

Cooley Vascular Scissor
 Curved

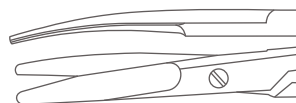

Catalog #	Size
SS-317-19	19 cm (7 1/2")

Vascular Scissors, Dissecting Scissors
 Gefäßscheren
 Tijeras vasculares, Tijeras de disección
 Ciseaux vasculaires, Ciseaux à dissection
 Forbici vascolari, Forbici per dissezione

Klinkenberg-Loth Vascular Scissor
 S Shaped

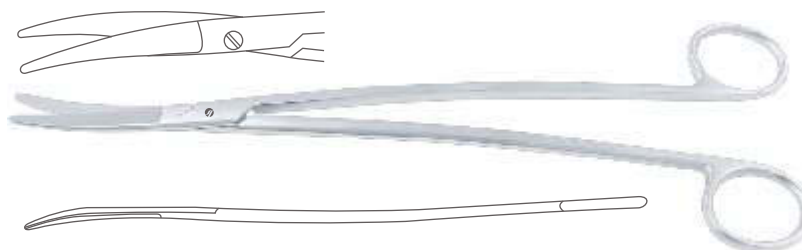

Catalog #	Size
SS-319-23	23 cm (9")

Olivecrona Trigeminal Scissor
 Toothed



Catalog #	Size, Working Le
SS-323-23	23 cm (9"), 120

Strully Neurological Scissor
 Curved

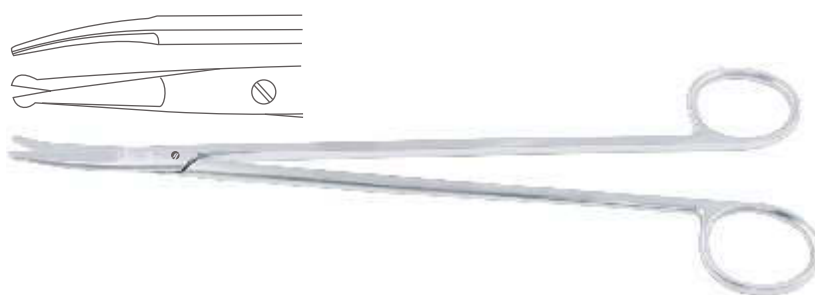

Catalog #	Size
SS-325-23	22.5 cm (8 3/4")

Schmieden-Taylor Dissecting Scissor
 One Blade Probed



Catalog #	Size
SS-327-17	16.5 cm (6 1/2")

Dissecting Scissors
 Präparierscheren
 Tijeras de disección
 Ciseaux à dissection
 Forbici per dissezione

Toennis-Adson Dissecting Scissor
 Curved

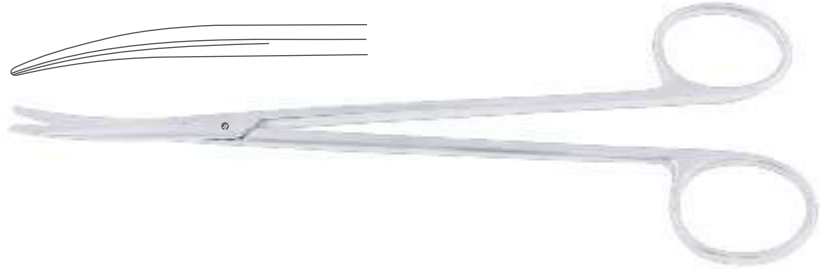

Catalog #	Size
SS-329-17	17.5 cm (7")

Toennis Dissecting Scissor
 Straight, Very Delicate

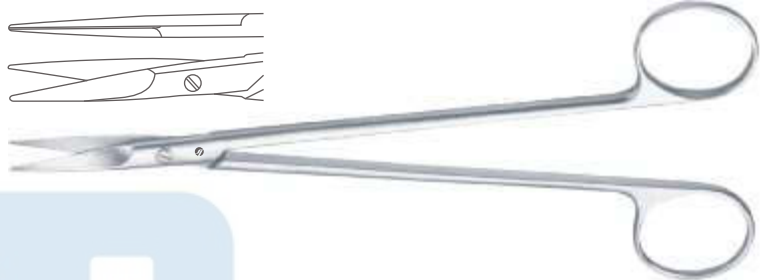

Catalog #	Size
SS-332-18	18 cm (7")

Toennis Dissecting Scissor
 Straight, Delicate



Catalog #	Size
SS-334-18	18 cm (7")

Toennis Dissecting Scissor
 Curved, Delicate



Catalog #	Size
SS-335-18	18 cm (7")

Killian Bone Shear

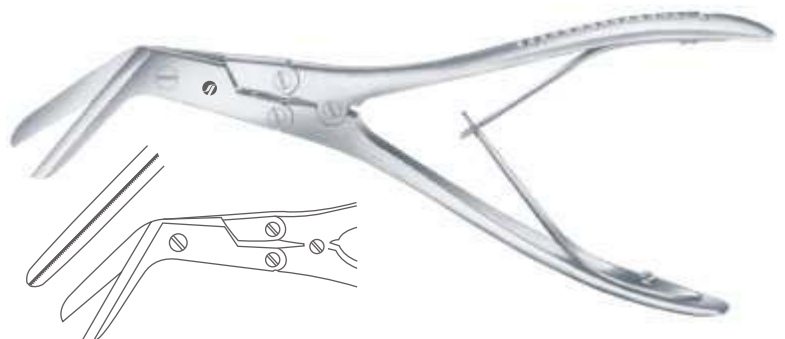

Catalog #	Size
SS-341-21	21 cm (8 1/4")

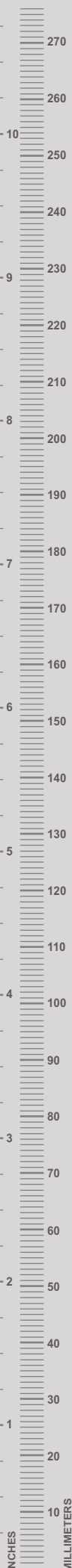

Tonsil and Nasal Scissors
 Tonsillen und Nasenscheren
 Tijeras para amígdalas, Tijeras nasales
 Ciseaux pour les amygdales, Ciseaux nasaux
 Forbici per tonsille, Forbici nasali

Muehling Bone Shear

Catalog #	Size
SS-343-21	21 cm (8 1/4")

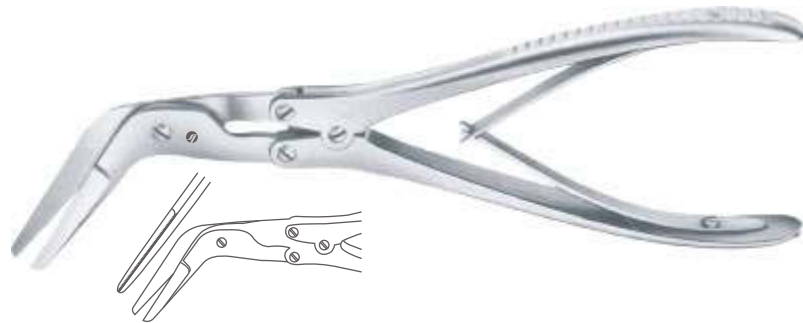

Caplan Septum Scissor
 One Toothed Cutting Edge

Catalog #	Size
SS-345-20	20 cm (8")



Prince Tonsil Scissor

Catalog #	Size
SS-347-18	18 cm (7")

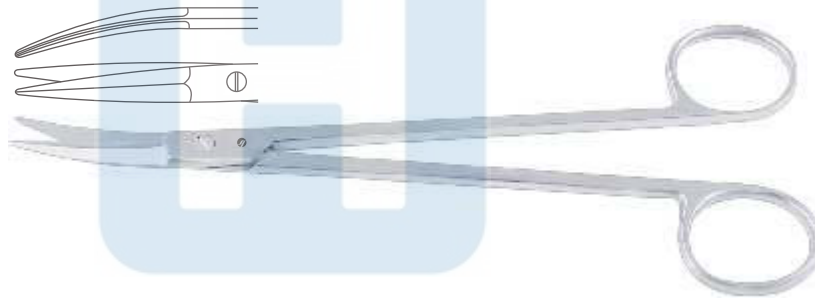

Dean Tonsil Scissor
 Angled Upwards

Catalog #	Size
SS-351-17	17.5 cm (7")



Dean Tonsil Scissor
 Toothed, Angled Upwards

Catalog #	Size
SS-353-17	17.5 cm (7")



Tonsil and Nasal Scissors
 Tonsillen und Nasenscheren
 Tijeras para amígdalas, Tijeras nasales
 Ciseaux pour les amygdales, Ciseaux nasaux
 Forbici per tonsille, Forbici nasali

Good Tonsil Scissor



Catalog #	Size
SS-355-19	19.5 cm (7 3/4")

Fomon Nasal Scissor



Catalog #	Size
SS-357-15	15 cm (6")

Fomon Nasal Scissor

SUPER Edge™



Catalog #	Size
SS-357-15 SC	15 cm (6")

Cottle Nasal Scissor

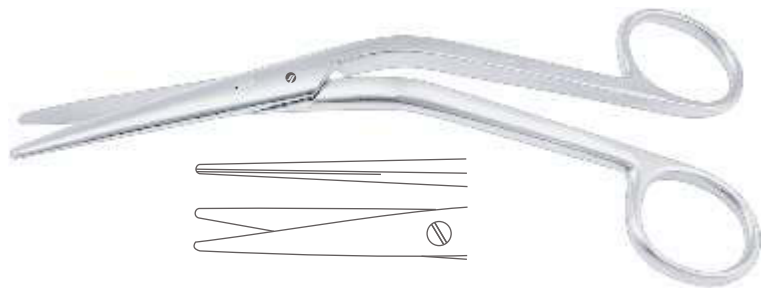

Catalog #	Size
SS-359-16	16 cm (6 1/4")

Cottle Nasal Scissor

SUPER Edge™



Catalog #	Size
SS-359-16 SC	16 cm (6 1/4")

INCHES
MILLIMETERS

Nasal Scissors, Episiotomy Scissors
 Nasenscheren, Episiotomiescheren
 Tijeras nasals, Tijeras para episiotomía
 Ciseaux nasaux, Ciseaux à épisiotomie
 Forbici nasali, Forbici per episiotomia

Heymann Nasal Scissor

Catalog #	Size
SS-361-18	18.5 cm (7 ¼")



Heymann Nasal Scissor

Catalog #	Size
SS-361-18 SC	18.5 cm (7 ¼")

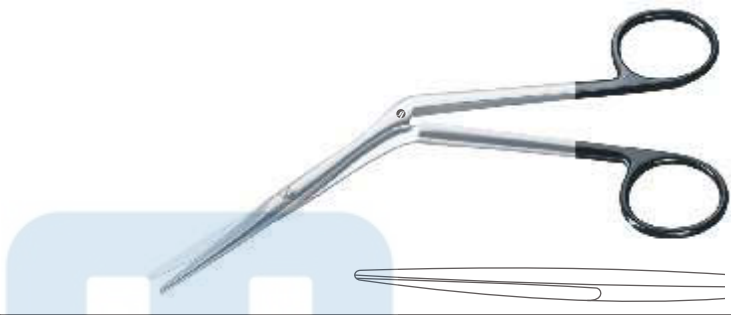

Heymann Nasal Scissor
 One Toothed Cutting Edge

Catalog #	Size
SS-363-18	18.5 cm (7 ¼")

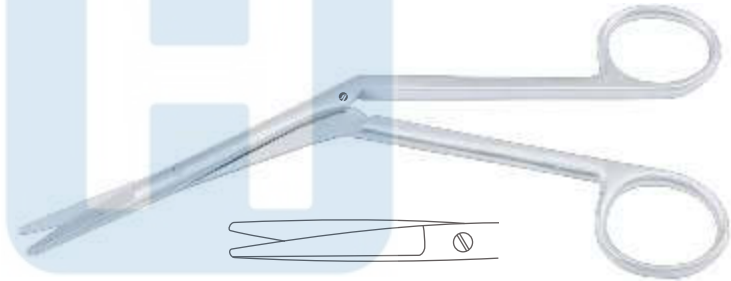

Converse (Graefe) Nasal Scissor
 Angled, Blunt/Blunt

Catalog #	Size
SS-367-11	10.5 cm (4 ¼")



Converse Nasal Scissor
 Angled, Sharp/Sharp

Catalog #	Size
SS-369-11	10.5 cm (4 ¼")



Nasal Scissors, Episiotomy Scissors, Umbilical Scissors
 Nasenscheren, Episiotomiescheren, Nabelschnurscheren
 Tijeras nasals, Tijeras para episiotomía, Tijeras umbilicales
 Ciseaux nasaux, Ciseaux à épisiotomie, Ciseaux pour le cordon ombilical
 Forbici nasali, Forbici per episiotomia, Forbici ombelicali

Waldmann Nasal Scissor
 One Toothed Cutting Edge

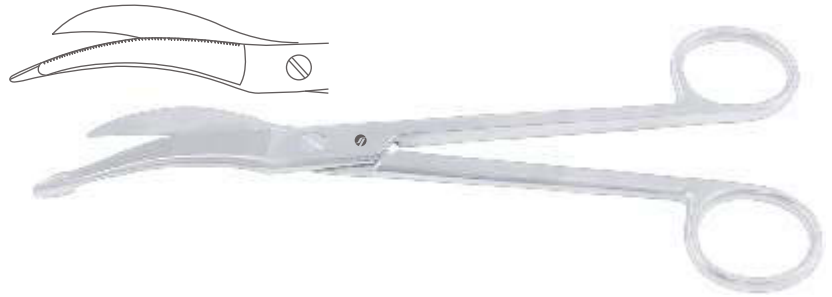

Catalog #	Size
SS-373-18	18 cm (7")

Braun-Stadler Episiotomy Scissor



Catalog #	Size
SS-381-14	14.5 cm (5 3/4")

Braun-Stadler Episiotomy Scissor



Catalog #	Size
SS-383-20	20 cm (8")
SS-383-22	22 cm (8 3/4")

Modell USA Umbilical Cord Scissor



Catalog #	Size
SS-385-10	10.5 cm (4 1/4")

Schumacher Umbilical Cord Scissor

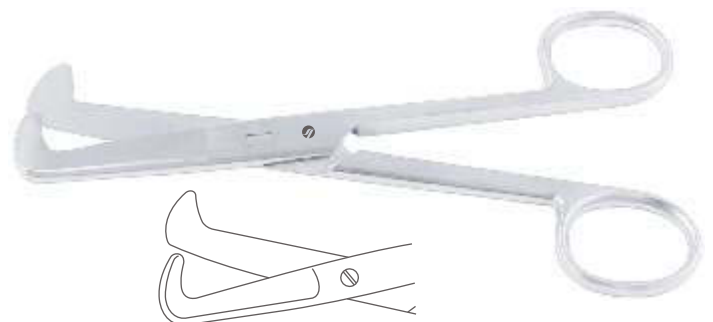

Catalog #	Size
SS-387-16	16 cm (6 1/4")

Umbilical Scissors, Gum Scissors
 Nabelschnurscheren, Zahnfleischscheren
 Tijeras umbilicales, Tijeras para encias
 Ciseaux pour le cordon ombilical, Ciseaux à gencives
 Forbici ombelicali, Forbici per gengiva

Busch Umbilical Cord Scissor



Catalog #	Size
SS-389-16	16 cm (6 1/4")

Busch Umbilical Cord Scissor
 One Toothed Cutting Edge



Catalog #	Size
SS-391-16	16 cm (6 1/4")

Goldman-Fox Gum Scissor
 Straight



Catalog #	Size
SS-400-13	13 cm (5")

Goldman-Fox Gum Scissor
 Straight

SUPER *Edge*™



Catalog #	Size
SS-400-13 SC	13 cm (5")

Goldman-Fox Gum Scissor
 Curved

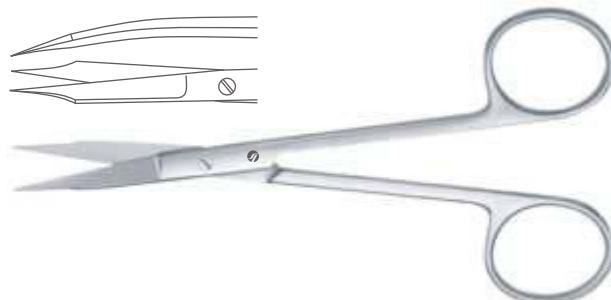

Catalog #	Size
SS-401-13	13 cm (5")

Gum Scissors, Operating Scissors
 Zahnfleischscheren, Chirurgische Scheren
 Tijeras para encías, Tijeras quirúrgicas
 Ciseaux à gencives, Ciseaux chirurgicaux
 Forbici per gengiva, Forbici per chirurgia

Goldman-Fox Gum Scissor
 Curved

SUPER Edge™

Catalog #	Size
SS-401-13 SC	13 cm (5")



Wagner Operating Scissor
 Straight

Catalog #	Size
SS-402-12	12 cm (4 3/4")



Wagner Operating Scissor
 Straight

SUPER Edge™

Catalog #	Size
SS-402-12 SC	12 cm (4 3/4")



Wagner Operating Scissor
 Curved

Catalog #	Size
SS-403-12	12 cm (4 3/4")



Wagner Operating Scissor
 Curved

SUPER Edge™

Catalog #	Size
SS-403-12 SC	12 cm (4 3/4")



INCHES
 MILLIMETERS

Operating Scissors, Gum Scissors
 Chirurgische Scheren, Zahnfleischscheren
 Tijeras quirúrgicas, Tijeras para encías
 Ciseaux chirurgicaux, Ciseaux à gencives
 Forbici per chirurgia, Forbici per gengiva

Fine Pattern Operating Scissor
 Straight, Sharp/Blunt

Catalog #	Size
SS-406-12	12 cm (4 ¾")

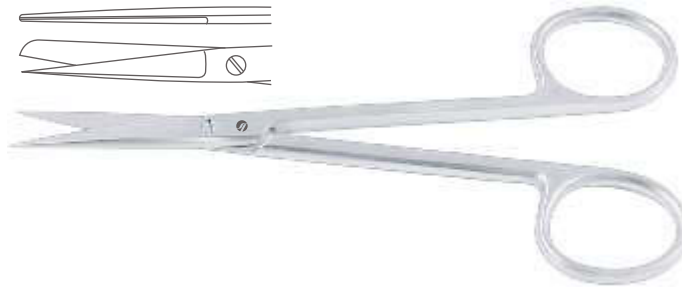

Fine Pattern Operating Scissor
 Curved, Sharp/Blunt

Catalog #	Size
SS-407-12	12 cm (4 ¾")



Fine Pattern Operating Scissor
 Straight, Sharp/Sharp

Catalog #	Size
SS-408-12	12 cm (4 ¾")

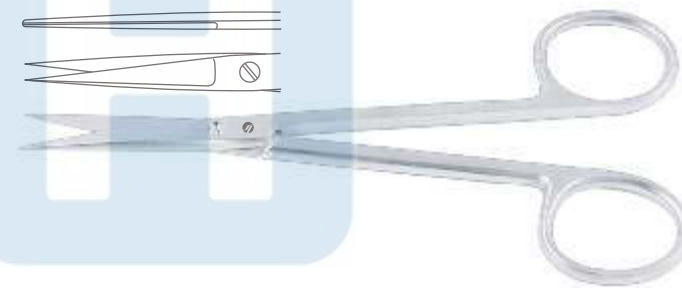

Fine Pattern Operating Scissor
 Curved, Sharp/Sharp

Catalog #	Size
SS-409-12	12 cm (4 ¾")

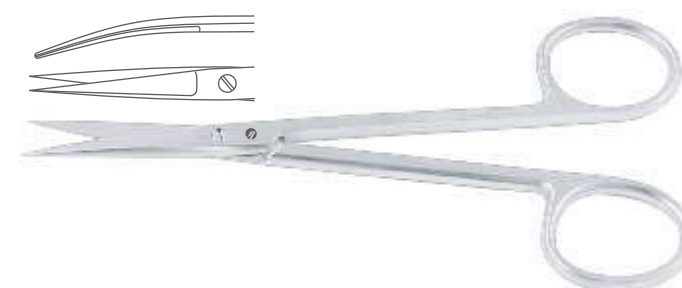

La Grange Gum Scissor
 S Shaped

Catalog #	Size
SS-411-11	11.5 cm (4 ½")

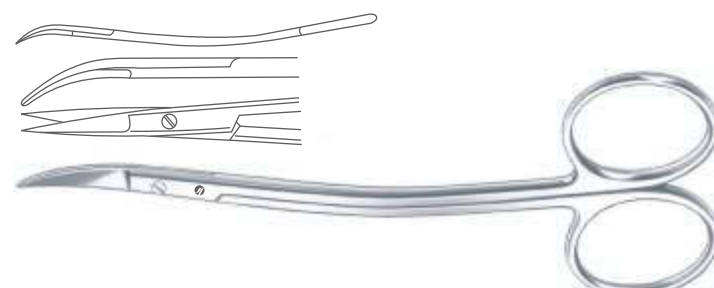

Gum Scissors, Operating Scissors
 Zahnfleissscheren, Chirurgische Scheren
 Tijeras para encías, Tijeras quirúrgicas
 Ciseaux à gencives, Ciseaux chirurgicaux
 Forbici per gengiva, Forbici per chirurgia

Delicate Gum Scissor
 Straight



Catalog #	Size
SS-414-11	11.5 cm (4 1/2")

Delicate Gum Scissor
 Curved

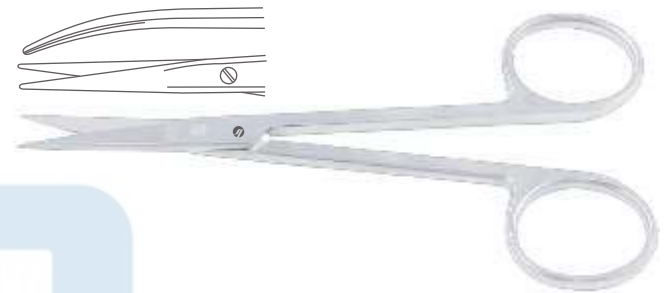

Catalog #	Size
SS-415-11	11.5 cm (4 1/2")

Locklin Gum Scissor
 Angled, One Toothed Cutting Edge

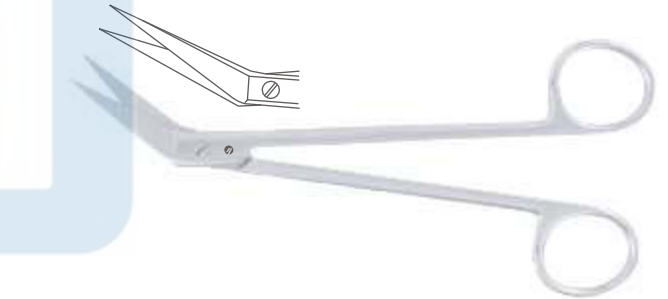

Catalog #	Size
SS-417-16	16 cm (6 1/4")

Locklin Gum Scissor
 Angled, S Shaped, One Toothed Cutting Edge

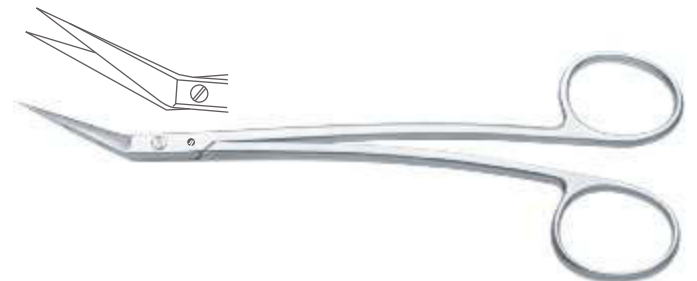

Catalog #	Size
SS-419-16	16 cm (6 1/4")

Very Delicate Operating Scissor
 Straight

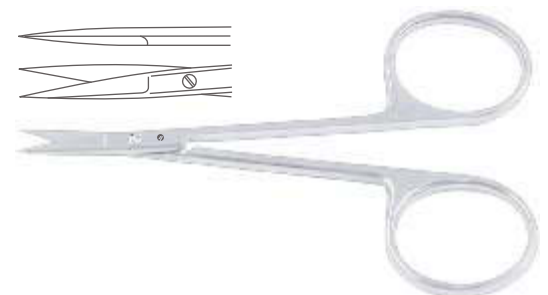

Catalog #	Size
SS-422-09	9 cm (3 1/2")

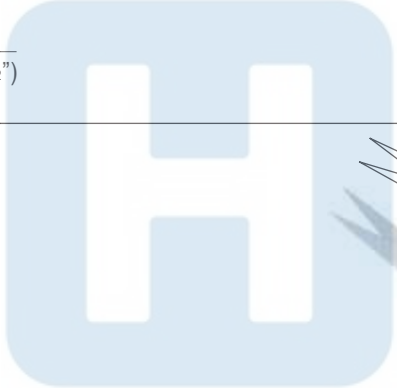

INCHES
 MILLIMETERS

Operating Scissors, Iris Scissors
 Chirurgische Scheren, Irisscheren
 Tijeras quirúrgicas, Tijeras para iridectomía
 Ciseaux chirurgicaux, Ciseaux à iridectomie
 Forbici per chirurgia, Forbici per iridectomia

Very Delicate Operating Scissor
 Curved

Catalog #	Size
SS-423-09	9 cm (3 ½")

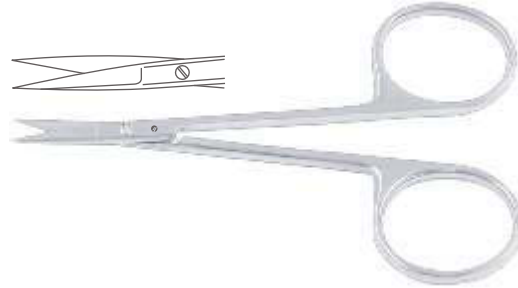

Iris Scissor
 Straight

Catalog #	Size
SS-430-09	9 cm (3 ½")
SS-430-10	10 cm (4")

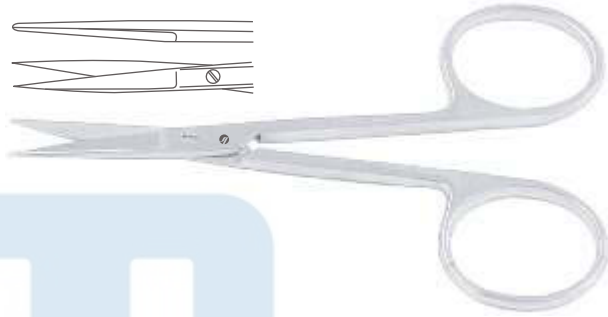

Iris Scissor
 Curved

Catalog #	Size
SS-431-09	9 cm (3 ½")
SS-431-10	10 cm (4")

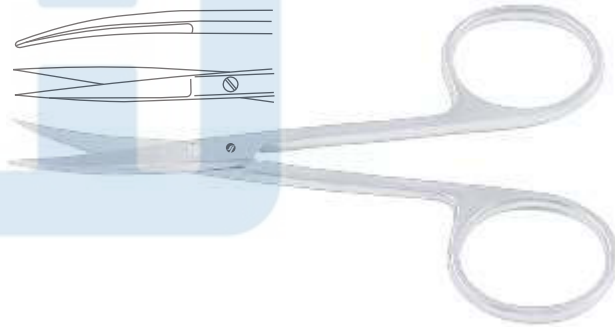

Iris Scissor
 With Extra Flat Blades

Catalog #	Size
SS-432-10	10 cm (4")

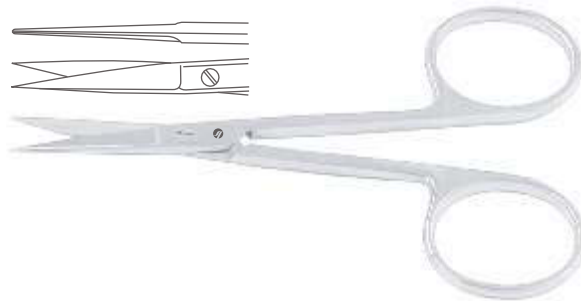

Bonn Iris Scissor
 Straight

Catalog #	Size
SS-434-09	9 cm (3 ½")



Iris Scissors
 Irisscheren
 Tijeras para iridectomía
 Ciseaux à iridectomie
 Forbici per iridectomia

Bonn Iris Scissor
 Curved

Catalog #	Size
SS-435-09	9 cm (3 1/2")



Iris Scissor
 Straight

Catalog #	Size
SS-440-11	11.5 cm (4 1/2")



Iris Scissor
 Straight

SUPER Edge™

Catalog #	Size
SS-440-11 SC	11.5 cm (4 1/2")



Iris Scissor
 Curved

Catalog #	Size
SS-441-11	11.5 cm (4 1/2")



Iris Scissor
 Curved

Catalog #	Size
SS-441-11 SC	11.5 cm (4 1/2")



INCHES
 MILLIMETERS

Iris Scissors
 Irisscheren
 Tijeras para iridectomia
 Ciseaux à iridectomie
 Forbici per iridectomia

SS

SCISSORS

Iris Scissor
 Curved to Side

Catalog #	Size
SS-443-11	11.5 cm (4 1/2")

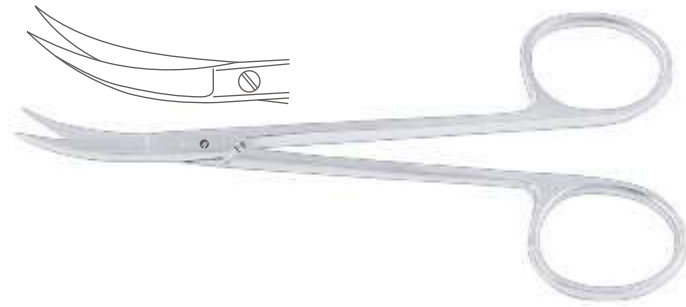

Iris Scissor
 Angled

Catalog #	Size
SS-445-11	11.5 cm (4 1/2")

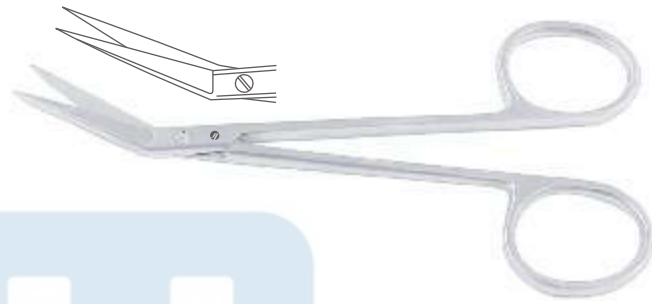

Iris Scissor
 Straight

Catalog #	Size
SS-446-12	12.5 cm (5")

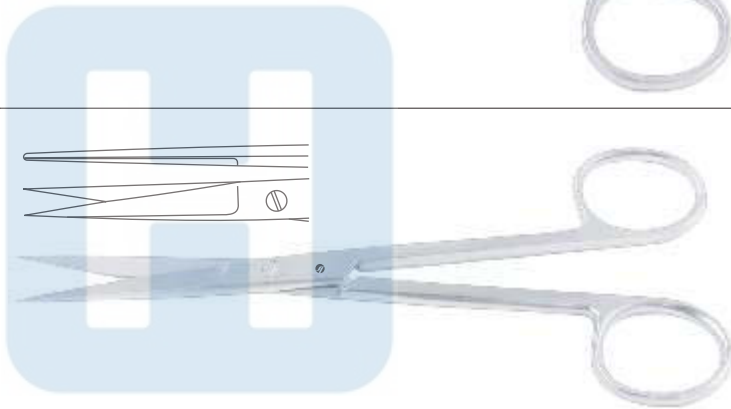

Iris Scissor
 Curved

Catalog #	Size
SS-447-12	12.5 cm (5")

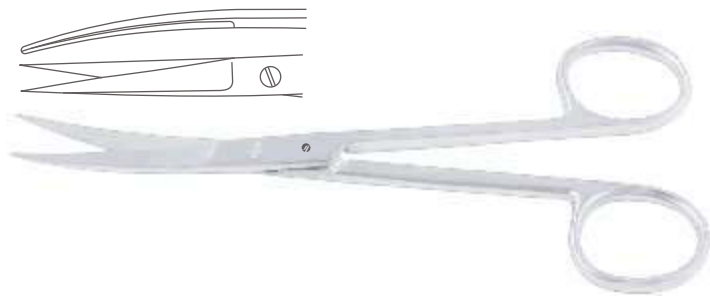

Stevens Tenotomy Scissor
 Straight, Sharp/Sharp

Catalog #	Size
SS-450-10	10 cm (4")
SS-450-11	11 cm (4 1/2")

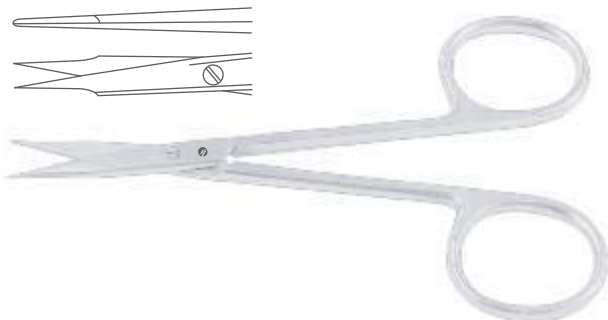

Iris Scissors, Tendon Scissors
 Irisscheren, Sehnenscheren
 Tijeras para iridectomía, Tijeras para tendones
 Ciseaux à iridectomie, Ciseaux à ténotomie
 Forbici per iridectomia, Forbici per tenotomia

Stevens Tenotomy Scissor
 Straight, Sharp/Sharp

SUPER Edge™

Catalog #	Size
SS-450-11 SC	11 cm (4 ½")



Stevens Tenotomy Scissor
 Curved, Sharp/Sharp

Catalog #	Size
SS-451-10	10 cm (4")
SS-451-11	11 cm (4 ½")

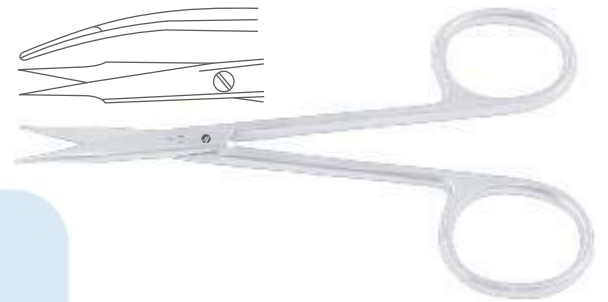

Stevens Tenotomy Scissor
 Curved, Sharp/Sharp

SUPER Edge™

Catalog #	Size
SS-451-11 SC	11 cm (4 ½")

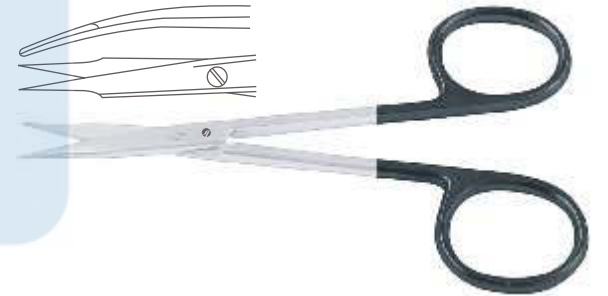

Stevens Tenotomy Scissor
 Straight, Blunt/Blunt

Catalog #	Size
SS-452-10	10 cm (4")
SS-452-11	11 cm (4 ½")
SS-452-12	12.5 cm (5")



Stevens Tenotomy Scissor
 Straight, Blunt/Blunt

SUPER Edge™

Catalog #	Size
SS-452-11 SC	11 cm (4 ½")

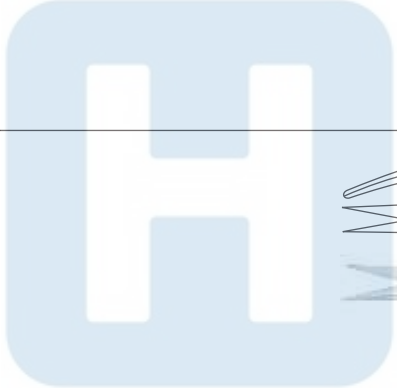

Iris Scissors, Strabismus Scissors
 Irisscheren, Strabismusscheren
 Tijeras para iridectomía, Tijeras para estrabismo
 Ciseaux à iridectomie, Ciseaux à strabisme
 Forbici per iridectomia, Forbici per strabismo

Stevens Tenotomy Scissor
 Curved, Blunt/Blunt

Catalog #	Size
SS-453-10	10 cm (4")
SS-453-11	11 cm (4 ½")
SS-453-12	12.5 cm (5")

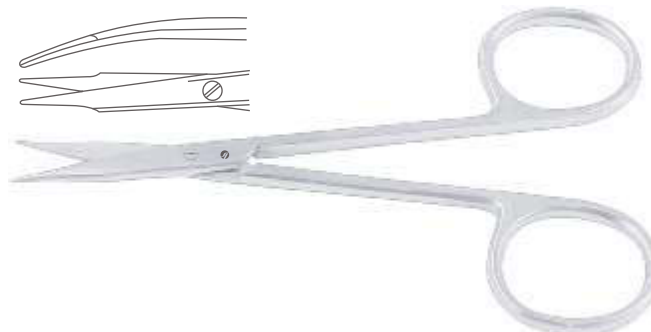

Stevens Tenotomy Scissor
 Curved, Blunt/Blunt

SUPER Edge™

Catalog #	Size
SS-453-11 SC	11 cm (4 ½")

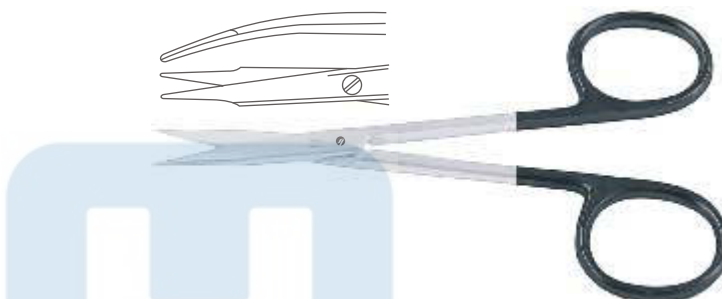

Strabismus Scissor
 Straight

Catalog #	Size
SS-456-11	11.5 cm (4 ½")

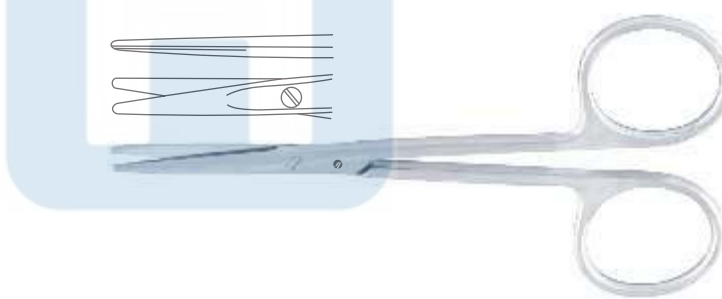

Strabismus Scissor
 Straight

SUPER Edge™

Catalog #	Size
SS-456-11 SC	11.5 cm (4 ½")



Strabismus Scissor
 Curved

Catalog #	Size
SS-457-11	11.5 cm (4 ½")

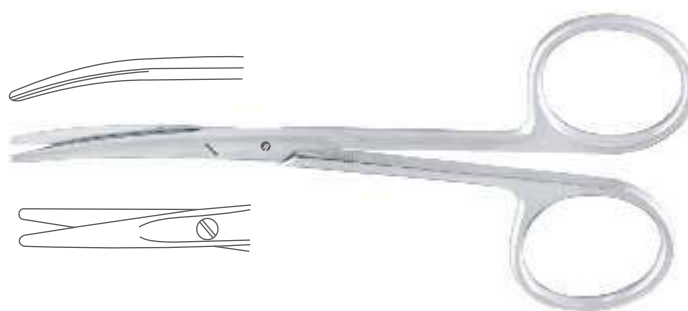

Strabismus Scissors, Dissecting Scissors
 Strabismusscheren, Präparierscheren
 Tijeras para estrabismo, Tijeras de disección
 Ciseaux à strabisme, Ciseaux à dissection
 Forbici per strabismo, Forbici per dissezione

Strabismus Scissor
 Curved

SUPER Edge™

Catalog #	Size
SS-457-11 SC	11.5 cm (4 1/2")

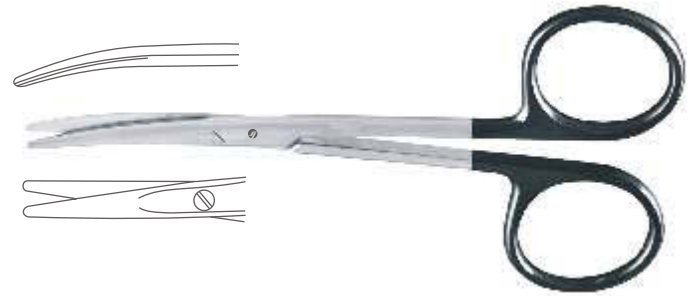

Littler Dissecting Scissor
 Curved, Tip With Eye For Suture

Catalog #	Size
SS-461-11	11.5 cm (4 1/2")



Cottle Bulldog Scissor
 Curved

Catalog #	Size
SS-463-11	11.5 cm (4 1/2")



Kilner Delicate Dissecting Scissor
 Straight

Catalog #	Size
SS-466-11	11.5 cm (4 1/2")



Enucleation Scissor
 Curved

Catalog #	Size
SS-469-11	11.5 cm (4 1/2")

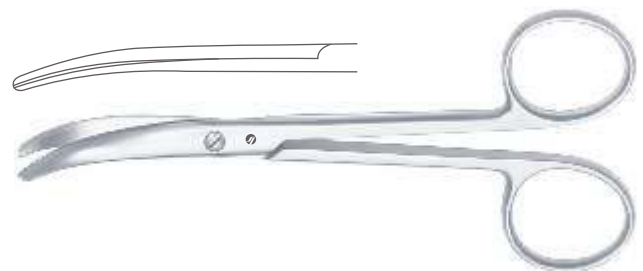

Dissecting Scissors, Face-lift Scissors
 Präparierscheren, Face-lift-Scheren
 Tijeras de disección, Tijeras para Face-Lift
 Ciseaux à dissection, Ciseaux pour Face-lift
 Forbici per dissezione, Forbici per Face-lift

Chadwick Delicate Scissor
 Curved

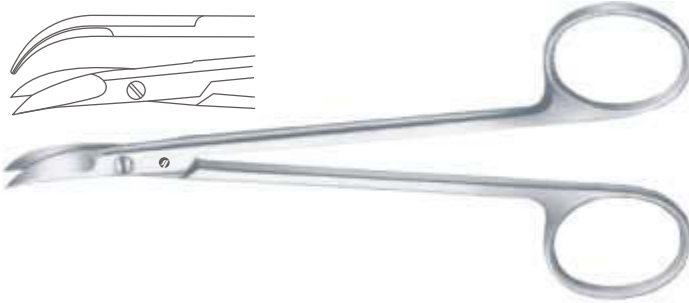

Catalog #	Size
SS-471-11	11.5 cm (4 1/2")

Quimby Delicate Scissor
 Curved



Catalog #	Size
SS-473-13	13 cm (5")

Nerve Dissecting Scissor
 Straight

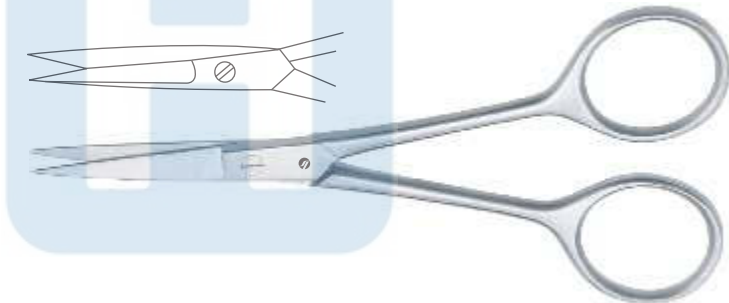

Catalog #	Size
SS-476-11	11 cm (4 1/2")
SS-476-13	13 cm (5")

Nerve Dissecting Scissor
 Curved



Catalog #	Size
SS-477-11	11 cm (4 1/2")
SS-477-13	13 cm (5")

Delicate Scissor
 Angled

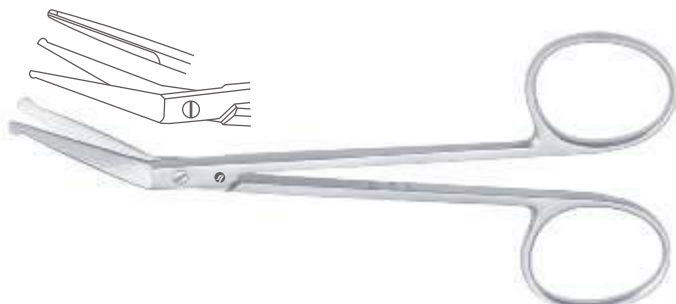

Catalog #	Size
SS-481-11	11.5 cm (4 1/2")

Face-lift Scissors
 Face-lift-Scheren
 Tijeras para Face-Lift
 Ciseaux pour Face-lift
 Forbici per Face-lift

Ribbon Salyer Scissor
 Straight, Flat Shanks

Catalog #	Size
SS-484-09	9.5 cm (3 3/4")

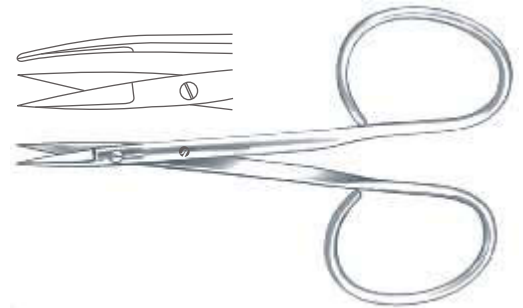

Ribbon Iris Scissor
 Straight, Sharp, Flat Shanks

Catalog #	Size
SS-486-09	9.5 cm (3 3/4")

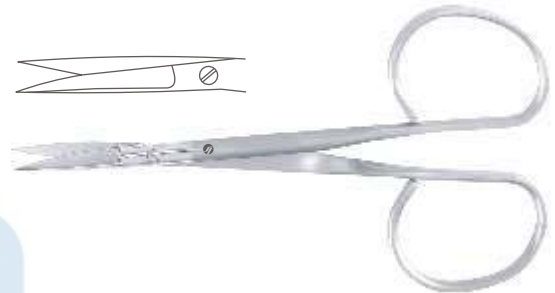

Ribbon Iris Scissor
 Curved, Sharp, Flat Shanks

Catalog #	Size
SS-487-09	9.5 cm (3 3/4")

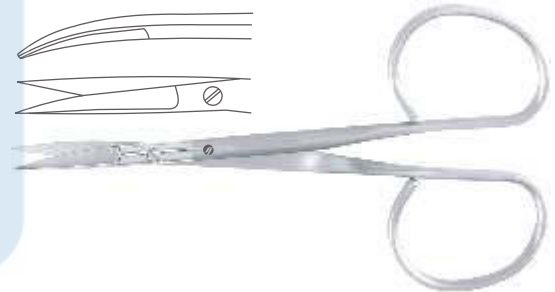

Ribbon Iris Scissor
 Straight, Blunt, Flat Shanks

Catalog #	Size
SS-488-10	10 cm (4")

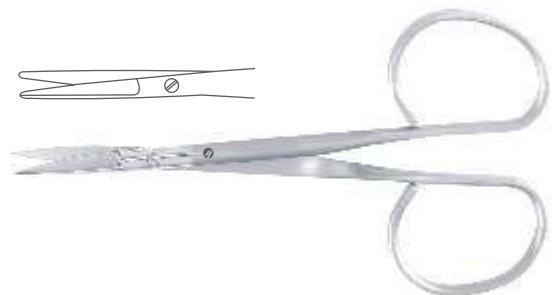

Ribbon Iris Scissor
 Curved, Blunt, Flat Shanks

Catalog #	Size
SS-489-10	10 cm (4")

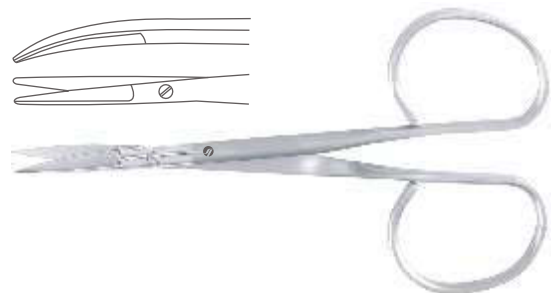

INCHES
 MILLIMETERS

Face-lift Scissors
 Face-lift-Scheren
 Tijeras para Face-Lift
 Ciseaux pour Face-lift
 Forbici per Face-lift

Ribbon Strabismus Scissor
 Straight, Flat Shanks

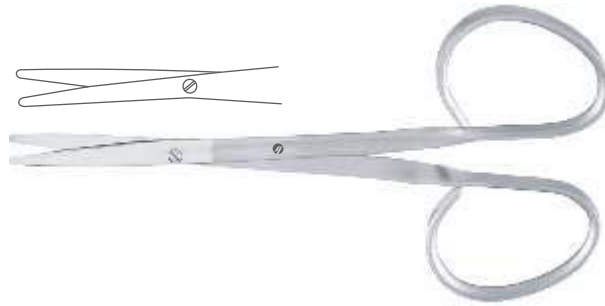

Catalog #	Size
SS-492-10	10 cm (4")

Ribbon Strabismus Scissor
 Curved, Flat Shanks



Catalog #	Size
SS-493-10	10 cm (4")

Ribbon Stevens Tenotomy Scissor
 Straight, Flat Shanks, Sharp Tips

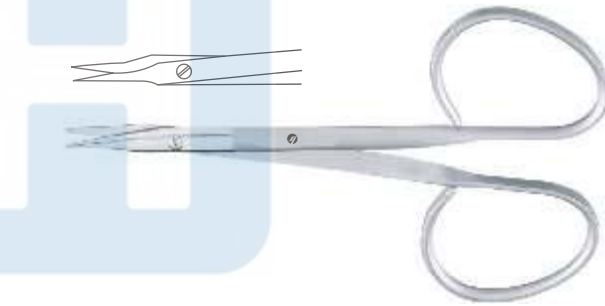

Catalog #	Size
SS-496-10	10 cm (4")

Ribbon Stevens Tenotomy Scissor
 Curved, Flat Shanks, Sharp Tips

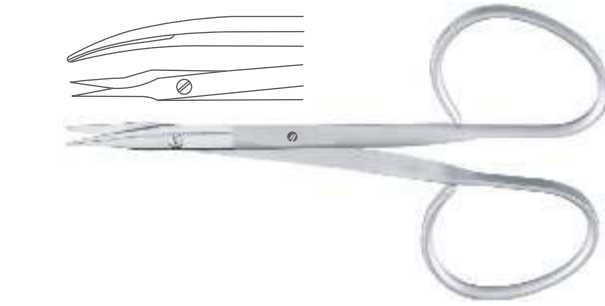

Catalog #	Size
SS-497-10	10 cm (4")

Ribbon Stevens Tenotomy Scissor
 Straight, Flat Shanks, Blunt Tips

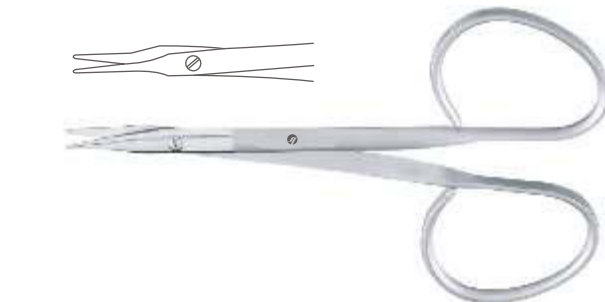

Catalog #	Size
SS-498-10	10 cm (4")

Face-lift Scissors, Enterotomy Scissors
 Face-lift-Scheren, Darmscheren
 Tijeras para Face-Lift, Tijeras para intestino
 Ciseaux pour Face-lift, Ciseaux-entérotomes
 Forbici per Face-lift, Forbici per enterotomia

Ribbon Stevens Tenotomy Scissor
 Curved, Flat Shanks, Blunt Tips

Catalog #	Size
SS-499-10	10 cm (4")



Ribbon Gradle Scissor
 Straight, Flat Shanks

Catalog #	Size
SS-500-10	10 cm (4")

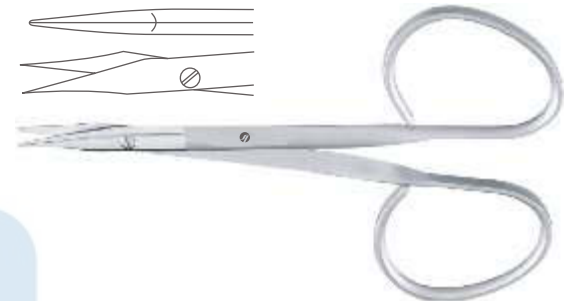

Ribbon Gradle Scissor
 Curved, Flat Shanks

Catalog #	Size
SS-501-10	10 cm (4")



Ribbon Kaye Face-Lift Scissor
 Curved, Flat Shanks, Toothed

Catalog #	Size
SS-507-11	11 cm (4 1/2")

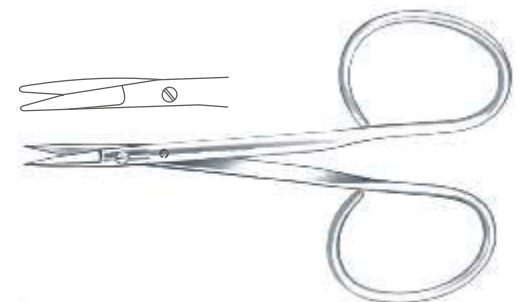

Enterotomy Scissor
 One Probe Tip

Catalog #	Size
SS-520-21	21.5 cm (8 1/2")

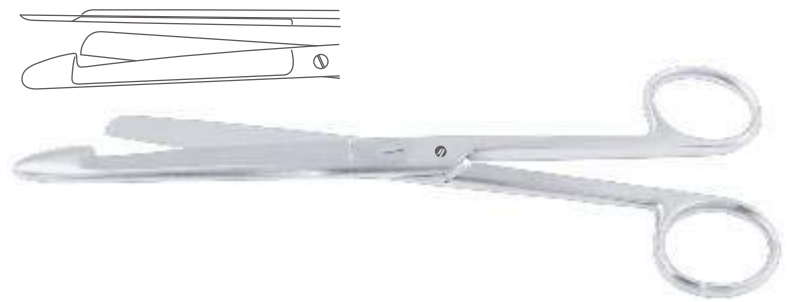

INCHES
 MILLIMETERS

Rectal Scissors
 Rektumschere
 Tijera para recto
 Ciseaux pour rectum
 Forbici per il retto

Enterotomy Scissor
 One Probe Tip

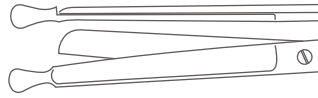

Catalog #	Size
SS-522-21	21.5 cm (8 1/2")

Rectal Scissor
 Curved, Heavy Pattern

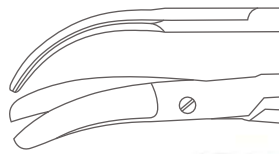

Catalog #	Size
SS-525-32	32.5 cm (12 3/4")

Bowel Dissecting Scissor
 Angled 60°

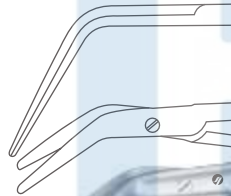

Catalog #	Size
SS-527-28	28 cm (11")

Lloyd-Davies (Goligher) Rectal Scissor
 Curved

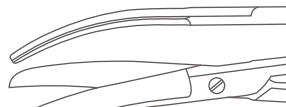

Catalog #	Size
SS-529-27	27 cm (10 3/4")

Stelzner Rectal Scissor
 Straight

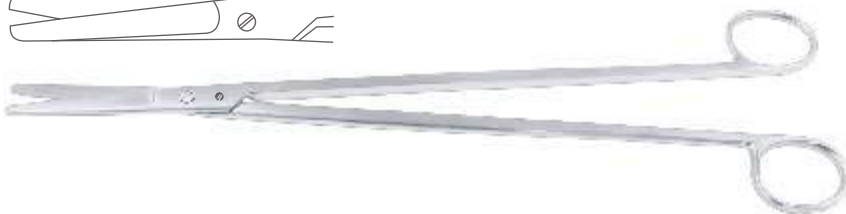
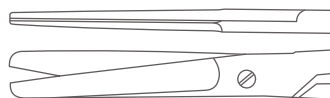

Catalog #	Size
SS-530-31	31 cm (12 1/4")

Rectal Scissors, Stitch Scissors
 Rektumschere, Fadenschere
 Tijera para recto, Tijeras para hilos
 Ciseaux pour rectum, Ciseaux à ligatures
 Forbici per il retto, Forbici per legature

Stelzner Rectal Scissor
 Curved

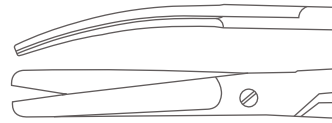

Catalog #	Size
SS-531-31	31 cm (12 1/4")

Mueller Rectal Scissor
 S Shaped

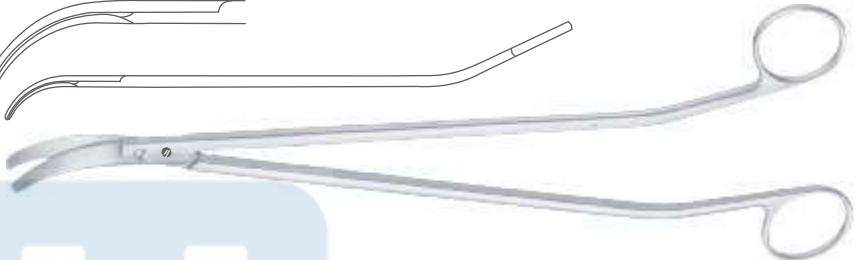
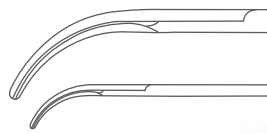

Catalog #	Size
SS-533-32	32.5 cm (12 3/4")

Northbent Stitch Scissor

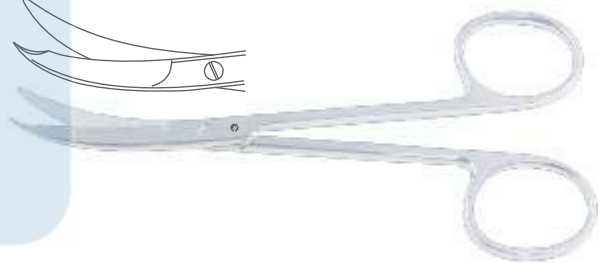
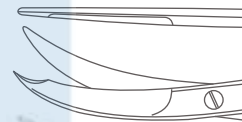

Catalog #	Size
SS-540-13	13 cm (5")

Spencer Stitch Scissor

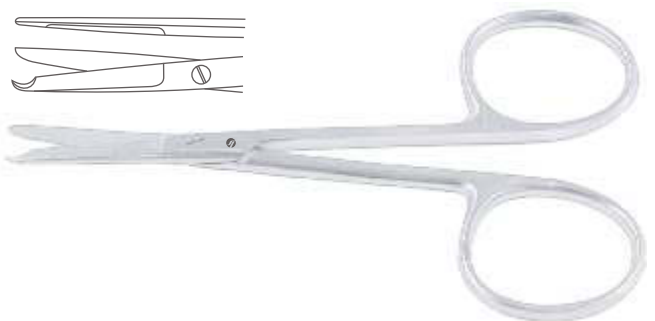
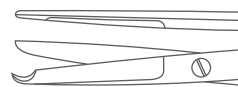

Catalog #	Size
SS-542-09	9 cm (3 1/2")
SS-542-13	13 cm (5")

Buck Stitch Scissor

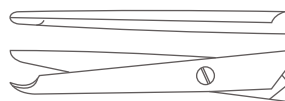

Catalog #	Size
SS-544-14	14.5 cm (5 3/4")
SS-544-18	18 cm (7")

Stitch Scissors, Wire Cutting Scissors, Crown Scissors
 Fadenscheren, Drahtscheren, Kronenscheren
 Tijeras para hilos, Tijeras para cortar hilos de acero, Tijeras para coronas
 Ciseaux à ligatures, Ciseaux coupe-fil, Ciseaux à couronnes
 Forbici per legature, Forbici per tagliare fili metallic, Forbici per corone

Littauer Stitch Scissor



Catalog #	Size
SS-546-14	14 cm (5 1/2")

Eiselberg Stitch Scissor

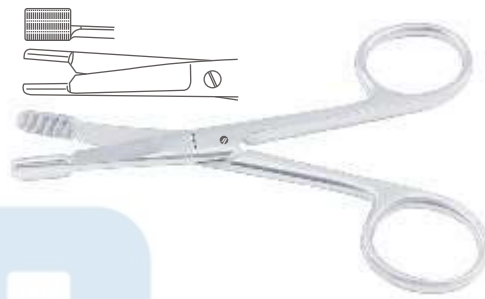

Catalog #	Size
SS-548-12	12 cm (4 3/4")

Universal Wire Cutting Scissor
 Angled, One Toothed Cutting Edge



Catalog #	Size
SS-551-12	12 cm (4 3/4")

Harvey Wire Cutting Scissor
 Straight, One Toothed Cutting Edge

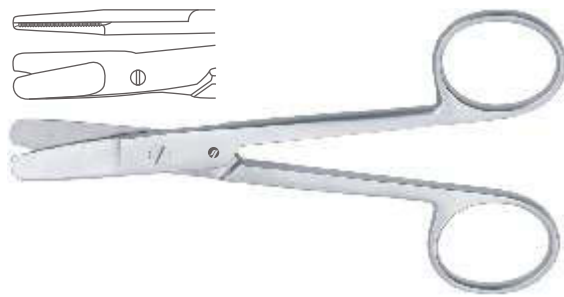

Catalog #	Size
SS-554-12	12.5 cm (5")

Beebee Crown Scissor
 Straight

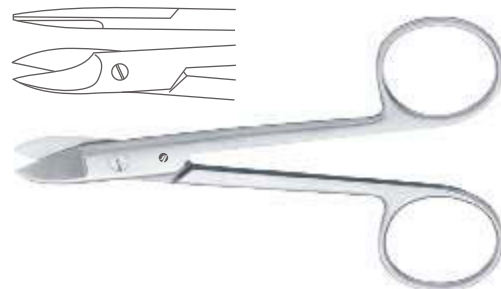

Catalog #	Size
SS-556-10	10.5 cm (4 1/4")

Crown Scissors, Nail Scissors
 Kronenscheren, Nagelscheren
 Tijeras para coronas, Tijeras para uñas
 Ciseaux à couronnes, Ciseaux à ongles
 Forbici per corone, Forbici per unghie

Beebee Crown Scissor
 Curved

Catalog #	Size
SS-557-10	10.5 cm (4 1/4")

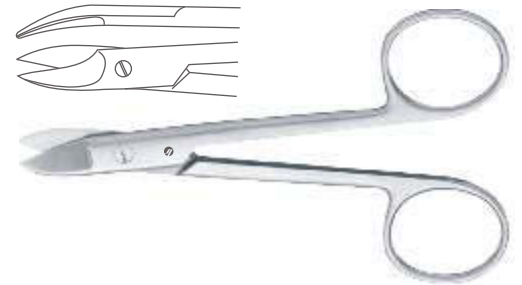

Beebee Crown Scissor
 Straight, One Toothed Cutting Edge

Catalog #	Size
SS-558-12	12 cm (4 3/4")

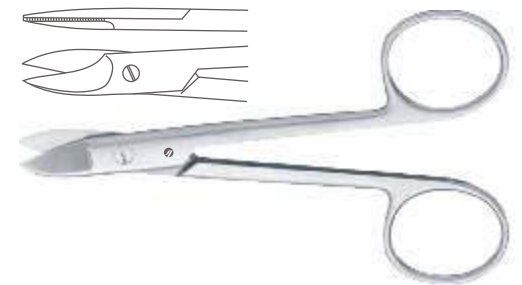

Beebee Crown Scissor
 Curved, One Toothed Cutting Edge

Catalog #	Size
SS-559-12	12 cm (4 3/4")



Nail Scissor

Catalog #	Size
SS-571-09	9 cm (3 1/2")



Nail Scissor
 Delicate Pattern

Catalog #	Size
SS-573-09	9 cm (3 1/2")

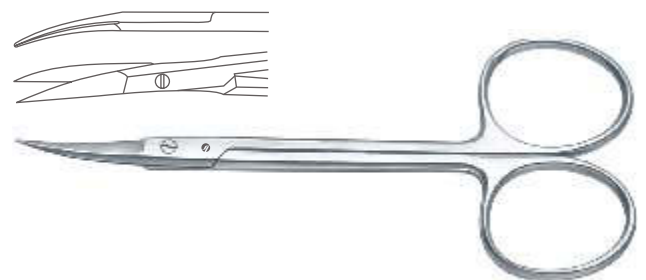

INCHES
 MILLIMETERS

Nail Scissors
 Nagelscheren
 Tijeras para uñas
 Ciseaux à ongles
 Forbici per unghie

Nail Scissor

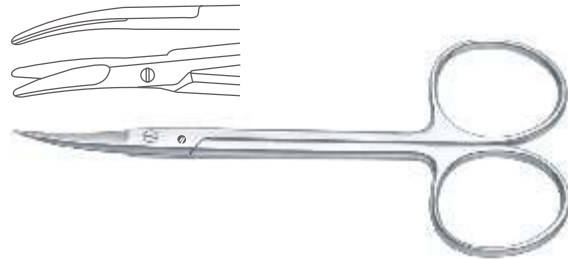

Catalog #	Size
SS-575-09	8.5 cm (3 1/4")

**Nail Scissor
 Straight**

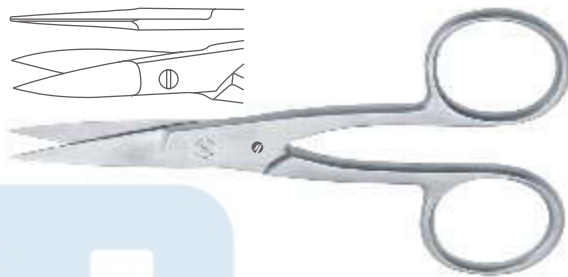

Catalog #	Size
SS-576-09	9 cm (3 1/2")

**Nail Scissor
 Curved**

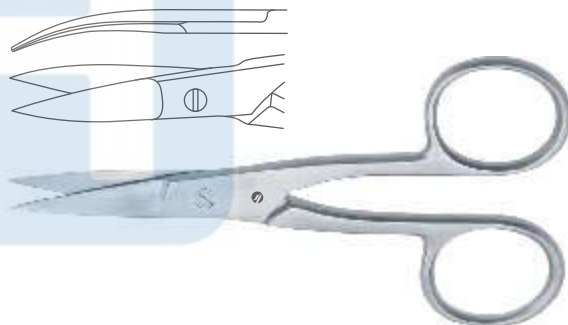

Catalog #	Size
SS-577-09	9 cm (3 1/2")
SS-577-10	10 cm (4")
SS-577-11	11 cm (4 1/2")

**Nail Scissor
 Straight**

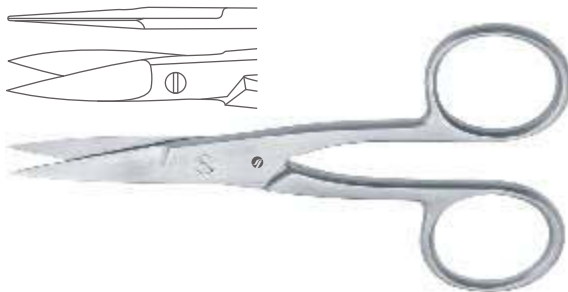

Catalog #	Size
SS-578-09	9.5 cm (3 3/4")

**Nail Scissor
 Curved**

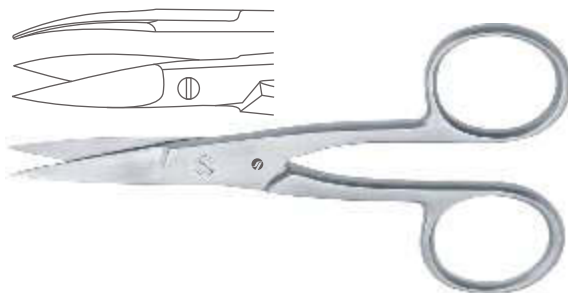

Catalog #	Size
SS-579-09	9.5 cm (3 3/4")
SS-579-10	10.5 cm (4 1/4")

Bandage Scissors
 Verbandscheren
 Tijeras para vendajes
 Ciseaux pour pansements
 Forbici per bendaggi

Smith (Mod. USA) Bandage Scissor



Catalog #	Size
SS-582-18	18 cm (7")
SS-582-20	20 cm (8")
SS-583-23	23 cm (9")

**Bandage Scissor
 Straight**

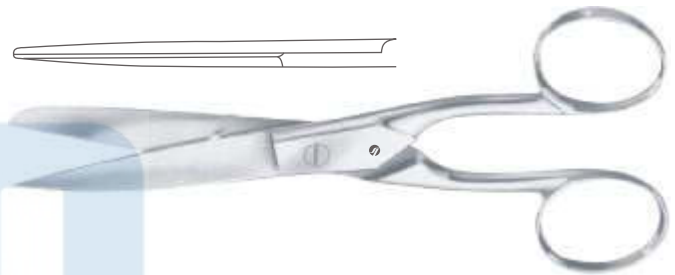

Catalog #	Size
SS-584-15	15 cm (6")

**Lorenz Bandage Scissor
 Heavy Pattern**



Catalog #	Size
SS-585-23	23 cm (9")

**Knowles Bandage Scissor
 Angled**



Catalog #	Size
SS-587-14	14 cm (5 1/2")

**Knowles Bandage Scissor (For Fingers)
 Straight**



Catalog #	Size
SS-588-14	14cm (5 1/2")

INCHES
 MILLIMETERS

Bandage Scissors
 Verbandscheren
 Tijeras para vendajes
 Ciseaux pour pansements
 Forbici per bendaggi

Lister Bandage Scissor



Catalog #	Size
SS-591-14	14.5 cm (5 ¾")
SS-591-18	18.5 cm (7 ¼")
SS-591-20	20 cm (8")

**Lister Bandage Scissor
 One Large Ring**

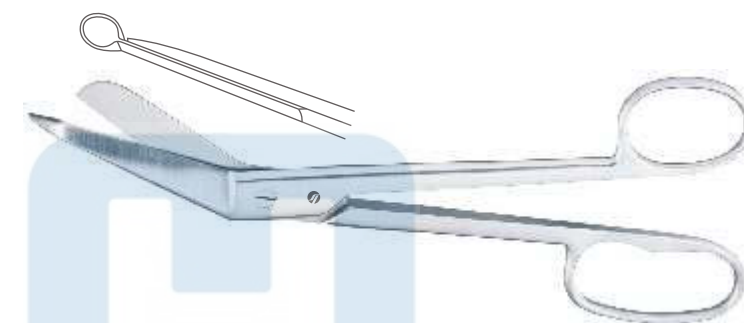

Catalog #	Size
SS-593-18	18.5 cm (7 ¼")
SS-593-21	21 cm (8 ¼")

**Lister (Eccentric) Bandage Scissor
 One Toothed Cutting Edge**

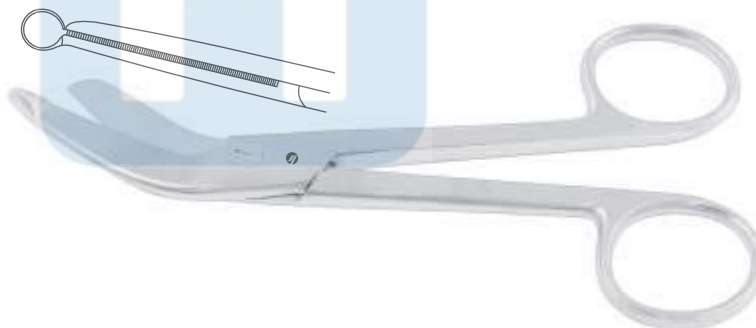

Catalog #	Size
SS-595-16	16 cm (6 ¼")
SS-595-19	19 cm (7 ½")

**Bergmann Bandage Scissor
 Heavy Pattern**



Catalog #	Size
SS-597-23	23.5 cm (9 ¼")

Bandage Scissors, Plaster Shears
 Verbandscheren, Gipsscheren
 Tijeras para vendajes, Tijeras para yeso
 Ciseaux pour pansements, Ciseaux pour plâtre
 Forbici per bendaggi, Forbici per gesso

Esmarch Bandage Scissor
 Heavy Pattern, Short Blades

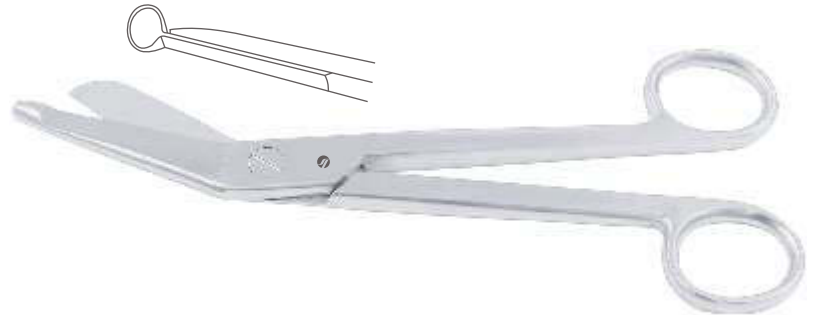

Catalog #	Size
SS-599-20	20 cm (8")
SS-599-23	23 cm (9")

Universal Bandage Scissor
 Plastic Handle



Catalog #	Size	Handle Colour
SS-601-14	14.5 cm (5 3/4")	Black
SS-601-16	16 cm (6 1/4")	Black
SS-601-18	18 cm (7 1/2")	Black
SS-603-14	14.5 cm (5 3/4")	Blue
SS-603-16	16 cm (6 1/4")	Blue
SS-603-18	18 cm (7 1/2")	Blue
SS-605-14	14.5 cm (5 3/4")	Red
SS-605-16	16 cm (6 1/4")	Red
SS-605-18	18 cm (7 1/2")	Red
SS-607-14	14.5 cm (5 3/4")	Green
SS-607-16	16 cm (6 1/4")	Green
SS-607-18	18 cm (7 1/2")	Green

Seutin Plaster of Paris Shear



Catalog #	Size
SS-609-23	23 cm (9")

Plaster Shears
Gipsscheren
Tijeras para yeso
Ciseaux pour plâtre
Forbici per gesso

Plaster of Paris Shear
One Toothed Cutting Edge

Catalog #	Size
SS-611-20	20 cm (8")



Bruns Plaster of Paris Shear
One Toothed Cutting Edge

Catalog #	Size
SS-613-24	24 cm (9 1/2")

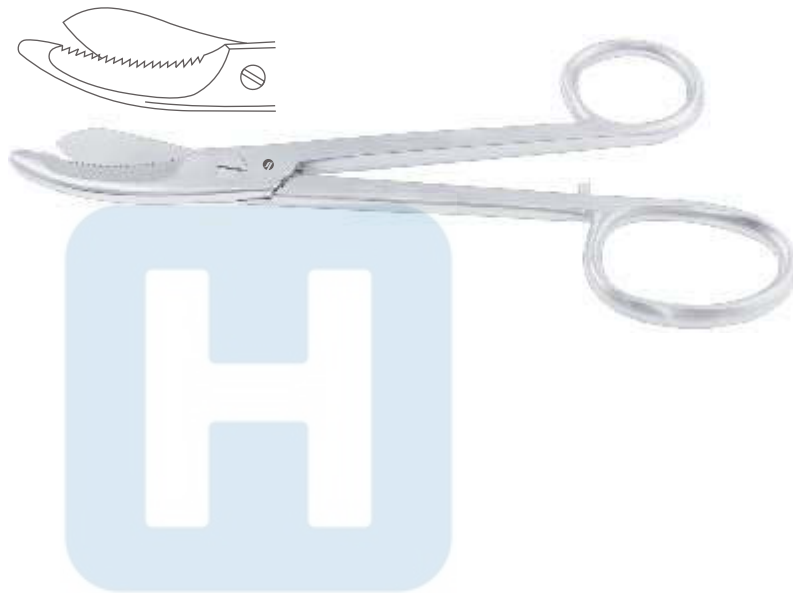

Micro Scissors
 Mikroscheren
 Micro-Tijeras
 Micro-Ciseaux
 Micro-Forbici

Noyes Iris Scissor
 Straight, Sharp/Sharp



Catalog #	Size
SS-630-12	12.5 cm (5")

Noyes Iris Scissor
 Curved, Sharp/Sharp



Catalog #	Size
SS-631-12	12.5 cm (5")

Noyes Iris Scissor
 Straight, Sharp/Blunt



Catalog #	Size
SS-632-12	12.5 cm (5")

Noyes Iris Scissor
 Curved, Sharp/Blunt



Catalog #	Size
SS-633-12	12.5 cm (5")

Noyes Iris Scissor
 Straight, Blunt/Blunt



Catalog #	Size
SS-634-12	12.5 cm (5")

INCHES
MILLIMETERS

Micro Scissors
Mikroscheren
Micro-Tijeras
Micro-Ciseaux
Micro-Forbici

Noyes Iris Scissor
Curved, Blunt/Blunt



Catalog #	Size
SS-635-12	12.5 cm (5")

Micro Scissor
Straight



Catalog #	Size
SS-636-12	12 cm (4 3/4")

Micro Scissor
Curved



Catalog #	Size
SS-637-12	12 cm (4 3/4")

Wecker Iris Scissor
Angled, Sharp/Sharp



Catalog #	Size
SS-641-11	11 cm (4 1/2")

Wecker Iris Scissor
Angled, Sharp/Blunt



Catalog #	Size
SS-643-11	11 cm (4 1/2")

Micro Scissors
 Mikroscheren
 Micro-Tijeras
 Micro-Ciseaux
 Micro-Forbici

Wecker Iris Scissor
 Angled, Blunt/Blunt



Catalog #	Size
SS-645-11	11 cm (4 1/2")

Barraquer Iris Scissor
 Angled



Catalog #	Size, Blade Size
SS-647-05	5.5 cm (2 1/4"), 5 mm
SS-647-07	5.5 cm (2 1/4"), 7 mm
SS-647-10	5.5 cm (2 1/4"), 10 mm

Castroviejo Corneoscleral Scissor
 Small Blades



Catalog #	Size, Profile
SS-651-01	10.5 cm (4"), Right
SS-651-02	10.5 cm (4"), Left

Castroviejo Corneoscleral Scissor
 Medium Blades



Catalog #	Size
SS-653-01	11 cm (4 1/2"), Right
SS-653-02	11 cm (4 1/2"), Left

Micro Scissors
Mikroscheren
Micro-Tijeras
Micro-Ciseaux
Micro-Forbici

SS

SCISSORS

Troutman-Castroviejo Corneoscleral Scissor
Small Blades, With Lock

Catalog #	Size, Profile
SS-655-01	10.5 cm (4"), Right
SS-655-02	10.5 cm (4"), Left



Troutman-Castroviejo Corneoscleral Scissor
Medium Blades, With Lock

Catalog #	Size, Profile
SS-657-01	11 cm (4 1/2"), Right
SS-657-02	11 cm (4 1/2"), Left



Troutman-Katzin Corneal Transplant Scissor
Strongly Curved, Small Blades With Lock

Catalog #	Size, Profile
SS-659-01	10.5 cm (4"), Right
SS-659-02	10.5 cm (4"), Left



Katzin Corneal Transplant Scissor
Strongly Curved, Medium Blades With Lock

Catalog #	Size, Profile
SS-661-01	11 cm (4 1/2"), Right
SS-661-02	11 cm (4 1/2"), Left



Micro Scissors
 Mikroscheren
 Micro-Tijeras
 Micro-Ciseaux
 Micro-Forbici

Castroviejo Universal Cornel Scissor
 Curved, Blunt Tips, Small Blades



Catalog #	Size, Profile
SS-663-11	11 cm (4 1/2"), Small Blades
SS-665-11	11 cm (4 1/2"), Medium Blades
SS-667-11	11 cm (4 1/2"), Large Blades

Castroviejo Universal Cornel Scissor
 Strongly Curved, Blunt Tips



Catalog #	Size
SS-669-11	11.5 cm (4 1/2")

Castroviejo Keratoplasty Scissor
 Angled, Blunt Tips, Medium Blades



Catalog #	Size
SS-671-11	11.5 cm (4 1/2")

McPherson-Westcott Conjunctival Scissor
 Curved, Blunt Tips, Small Blades



Catalog #	Size
SS-673-11	11 cm (4 1/2")

Westcott Tenotomy Scissor
 Curved, Blunt Tips, Medium Blades



Catalog #	Size
SS-675-11	11 cm (4 1/2")

Micro Scissors
Mikroscheren
Micro-Tijeras
Micro-Ciseaux
Micro-Forbici

SS

SCISSORS

Westcott Tenotomy Scissor
Curved, Blunt Tips, Standard Blades



Catalog #	Size, Profile
SS-677-01	11.5 cm (4 1/2"), Right
SS-677-02	11.5 cm (4 1/2"), Left

Tibolt Punctal Scissor
One Conically Shaped Blade with Micro Grooves & Textured Surface



Catalog #	Size
SS-679-11	11.5 cm (4 1/2")

McPherson-Westcott Stitch Scissor
Curved, Very Sharp Pointed Tips, Small Blades



Catalog #	Size
SS-681-11	11 cm (4 1/2")

Westcott Stitch Scissor
Curved, Very Sharp Pointed Tips, Standard Blades



Catalog #	Size
SS-683-11	11.5 cm (4 1/2")

Jaffe Stitch Scissor
Curved, Very Sharp Pointed Tips, Medium Blades



Catalog #	Size
SS-685-11	11 cm (4 1/2")

Micro Scissors
 Mikroscheren
 Micro-Tijeras
 Micro-Ciseaux
 Micro-Forbici

Iris Micro Scissor
 Straight, Sharp Tips, Small Blades



Catalog #	Size
SS-688-11	11 cm (4 1/2")

Iris Micro Scissor
 Curved, Sharp Tips, Small Blades



Catalog #	Size
SS-689-11	11 cm (4 1/2")

Fine Micro Scissor
 Straight, Sharp Tips, Medium Blades



Catalog #	Size
SS-690-11	11.5 cm (4 1/2")

Fine Stitch Scissor
 Curved, Sharp Tips, Medium Blades



Catalog #	Size
SS-691-11	11.5 cm (4 1/2")

Vannas Capsulotomy Scissor
 Straight, Sharp Tips



Catalog #	Size, Blade Size
SS-694-08	8 cm (3 1/4"), 5 mm

Micro Scissors
Mikroscheren
Micro-Tijeras
Micro-Ciseaux
Micro-Forbici

SS

SCISSORS

Vannas Capsulotomy Scissor
Curved, Sharp Tips



Catalog #	Size, Blade Size
SS-695-08	8 cm (3 1/4"), 5 mm

Vannas Capsulotomy Scissor
Angled Forward, Sharp Tips



Catalog #	Size, Blade Size
SS-696-08	8 cm (3 1/4"), 5 mm

Vannas Capsulotomy Scissor
Angled to Side, Sharp Tips



Catalog #	Size, Blade Size
SS-697-08	8 cm (3 1/4"), 5 mm

Gills-Vannas Capsulotomy Scissor
Straight, Sharp Tips



Catalog #	Size, Blade Size
SS-698-08	8 cm (3 1/4"), 7 mm

Gills-Vannas Capsulotomy Scissor
Curved, Sharp Tips



Catalog #	Size, Blade Size
SS-699-08	8 cm (3 1/4"), 7 mm

Micro Scissors
 Mikroscheren
 Micro-Tijeras
 Micro-Ciseaux
 Micro-Forbici

Gills-Vannas Capsulotomy Scissor
 Angled Forward, Sharp Tips



Catalog #	Size, Blade Size
SS-701-08	8 cm (3 1/4"), 7 mm

McPherson-Vannas Iris Scissor
 Curved, Sharp Tips



Catalog #	Size
SS-703-08	8 cm (3 1/4")

Gills-Vannas Micro Scissor
 Straight, Sharp Tips, Extra Thin



Catalog #	Size, Blade Size
SS-706-10	10.5 cm (4"), 7 mm

Gills-Vannas Micro Scissor
 Curved, Sharp Tips, Extra Thin



Catalog #	Size, Blade Size
SS-707-10	10.5 cm (4"), 7 mm

Gills-Vannas Micro Scissor
 Angled Forward, Sharp Tips, Extra Thin



Catalog #	Size, Blade Size
SS-709-10	10.5 cm (4"), 7 mm

Micro Scissors
Mikroscheren
Micro-Tijeras
Micro-Ciseaux
Micro-Forbici

Stern-Gills Micro Scissor
Straight, Sharp Tips, Extra Thin



Catalog #	Size, Blade Size
SS-710-11	11 cm (4 1/2"), 10 mm

Stern-Gills Micro Scissor
Curved, Sharp Tips, Extra Thin



Catalog #	Size, Blade Size
SS-711-11	11 cm (4 1/2"), 10 mm

Stern-Gills Micro Scissor
Angled Forward, Sharp Tips, Extra Thin



Catalog #	Size, Blade Size
SS-713-11	11 cm (4 1/2"), 10 mm

Gills Capsulotomy Scissor
Angled Blades With Curved Tips, Sharp Points



Catalog #	Size, Blade Size
SS-715-11	10.5 cm (4"), 10 mm

Vannas Micro Scissor
Straight

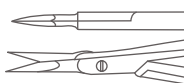

Catalog #	Size
SS-726-12	12 cm (4 3/4")

Micro Scissors
 Mikroscheren
 Micro-Tijeras
 Micro-Ciseaux
 Micro-Forbici

Vannas Micro Scissor
 Curved



Catalog #	Size
SS-727-12	12 cm (4 3/4")

Vannas Micro Scissor
 Angled on Flat



Catalog #	Size
SS-729-12	12 cm (4 3/4")

Biemer Vein Scissor



Catalog #	Size
SS-730-13	13 cm (5")

Micro Scissor
 Straight



Catalog #	Size
SS-732-16	16 cm (6 1/4")

Micro Scissor
 Curved



Catalog #	Size
SS-733-16	16 cm (6 1/4")

Micro Scissors
 Mikroscheren
 Micro-Tijeras
 Micro-Ciseaux
 Micro-Forbici

Jacobson Micro Scissor
 Curved

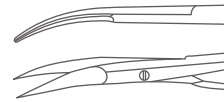

Catalog #	Size
SS-739-18	18.5 cm (7 1/4")

Adventitia Micro Scissor
 Straight, Sharp/Sharp

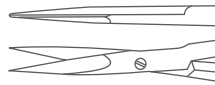

Catalog #	Size
SS-740-14	14.5 cm (5 3/4")

Micro Scissor
 Curved, Sharp/Sharp

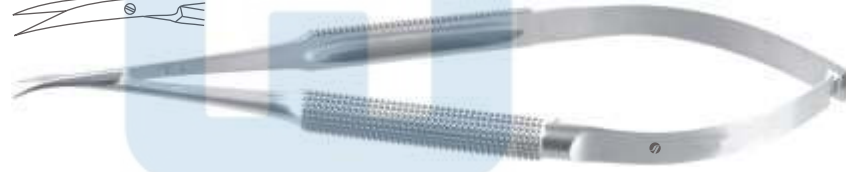
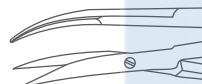

Catalog #	Size
SS-741-14	14.5 cm (5 3/4")

Micro Dissecting Scissor
 Curved, Blunt/Blunt



Catalog #	Size
SS-743-14	14.5 cm (5 3/4")

Micro Scissor
 Straight, Delicate Blades



Catalog #	Size
SS-744-16	16.5 cm (6 1/2")

Micro Scissors
 Mikroscheren
 Micro-Tijeras
 Micro-Ciseaux
 Micro-Forbici

Micro Scissor
 Curved, Delicate Blades



Catalog #	Size
SS-745-16	16.5 cm (6 1/2")

Micro Scissor
 Straight, Extra Delicate Blades



Catalog #	Size
SS-746-16	16.5 cm (6 1/2")

Micro Scissor
 Curved, Extra Delicate Blades



Catalog #	Size
SS-747-16	16.5 cm (6 1/2")

Vannas Micro Scissor
 Straight



Catalog #	Size
SS-734-16	16 cm (6 1/4")

Vannas Micro Scissor
 Curved



Catalog #	Size
SS-735-16	16 cm (6 1/4")

INCHES
 MILLIMETERS

Micro Scissors
 Mikroscheren
 Micro-Tijeras
 Micro-Ciseaux
 Micro-Forbici

Millesi Micro Scissor
 Straight



Catalog #	Size
SS-736-16	16 cm (6 1/4")

Millesi Micro Scissor
 Curved



Catalog #	Size
SS-737-16	16 cm (6 1/4")

Yasargil Micro Scissor
 Straight

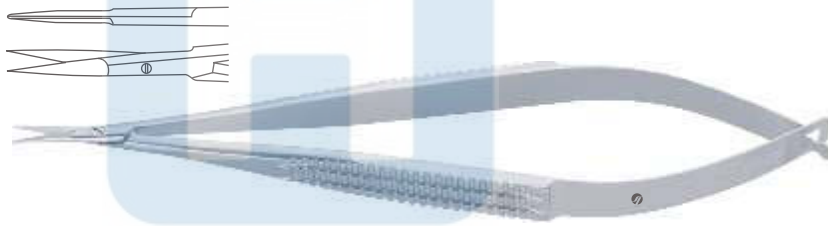

Catalog #	Size
SS-738-18	18.5 cm (7 1/4")

Micro Scissors
 Mikroscheren
 Micro-Tijeras
 Micro-Ciseaux
 Micro-Forbici

Micro Coronary Scissor



Catalog #	Size, Profile
SS-751-25	18 cm (7"), Angled 25°
SS-751-45	18 cm (7"), Angled 45°
SS-751-60	18 cm (7"), Angled 60°
SS-751-90	18 cm (7"), Angled 90°
SS-753-00	18 cm (7"), Angled 125°

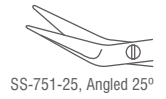

SS-751-25, Angled 25°



SS-751-45, Angled 45°



SS-751-60, Angled 60°



SS-751-90, Angled 90°



SS-753-00, Angled 125°

**Micro Coronary Scissor
 Titanium**



Catalog #	Size, Profile
SS-751-25 T	18 cm (7"), Angled 25°
SS-751-45 T	18 cm (7"), Angled 45°
SS-751-60 T	18 cm (7"), Angled 60°
SS-751-90 T	18 cm (7"), Angled 90°
SS-753-00 T	18 cm (7"), Angled 125°



SS-751-25 T, Angled 25°



SS-751-45 T, Angled 45°



SS-751-60 T, Angled 60°



SS-751-90 T, Angled 90°



SS-753-00 T, Angled 125°

Micro Scissors
Mikroscheren
Micro-Tijeras
Micro-Ciseaux
Micro-Forbici

Micro Coronary Scissor
Fine Blade



Catalog #	Size, Profile
SS-755-25	16.5 cm (6 1/2"), Angled 25°
SS-755-45	16.5 cm (6 1/2"), Angled 45°
SS-755-60	16.5 cm (6 1/2"), Angled 60°
SS-755-90	16.5 cm (6 1/2"), Angled 90°
SS-757-00	16.5 cm (6 1/2"), Angled 125°

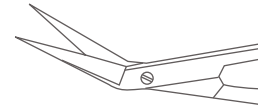

SS-755-25, Angled 25°

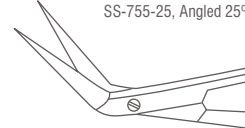

SS-755-45, Angled 45°



SS-755-60, Angled 60°



SS-755-90, Angled 90°



SS-757-00, Angled 125°

Micro Coronary Scissor
Fine Blades, One Blade with Probe Tip



Catalog #	Size, Profile
SS-759-25	16.5 cm (6 1/2"), Angled 25°
SS-759-45	16.5 cm (6 1/2"), Angled 45°
SS-759-60	16.5 cm (6 1/2"), Angled 60°
SS-759-90	16.5 cm (6 1/2"), Angled 90°
SS-761-00	16.5 cm (6 1/2"), Angled 125°

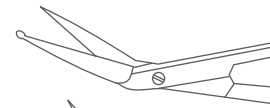

SS-759-25, Angled 25°

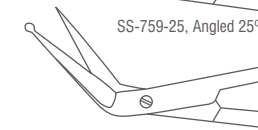

SS-759-45, Angled 45°



SS-759-60, Angled 60°



SS-759-90, Angled 90°

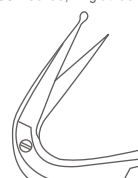

SS-761-00, Angled 125°

Micro Scissors
 Mikroscheren
 Micro-Tijeras
 Micro-Ciseaux
 Micro-Forbici

Micro Coronary Scissor
 Delicate Blades

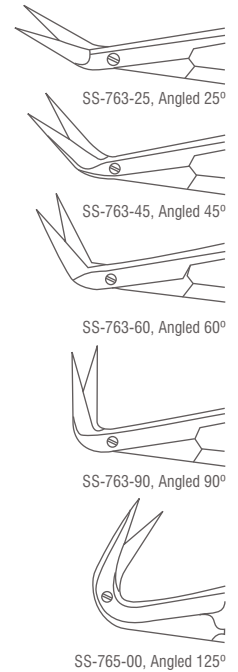

Catalog #	Size, Profile
SS-763-25	16.5 cm (6 1/2"), Angled 25°
SS-763-45	16.5 cm (6 1/2"), Angled 45°
SS-763-60	16.5 cm (6 1/2"), Angled 60°
SS-763-90	16.5 cm (6 1/2"), Angled 90°
SS-765-00	16.5 cm (6 1/2"), Angled 125°

Micro Coronary Scissor
 Extra Delicate Blades

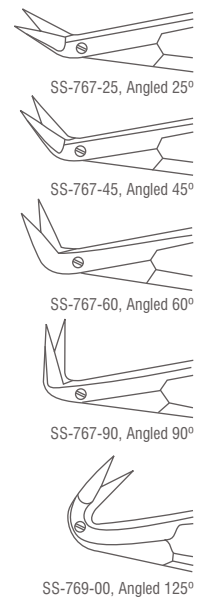

Catalog #	Size, Profile
SS-767-25	16.5 cm (6 1/2"), Angled 25°
SS-767-45	16.5 cm (6 1/2"), Angled 45°
SS-767-60	16.5 cm (6 1/2"), Angled 60°
SS-767-90	16.5 cm (6 1/2"), Angled 90°
SS-769-00	16.5 cm (6 1/2"), Angled 125°

Micro Scissors
 Mikroscheren
 Micro-Tijeras
 Micro-Ciseaux
 Micro-Forbici

Micro Scissor
 Straight, Delicate Blades, Round Handle



Catalog #	Size
SS-770-16	16.5 cm (6 1/2")

Micro Scissor
 Curved, Delicate Blades, Round Handle



Catalog #	Size
SS-771-16	16.5 cm (6 1/2")

Micro Scissor
 Curved, Extra Delicate Blades, Round Handle



Catalog #	Size
SS-773-16	16.5 cm (6 1/2")

Micro Scissors
 Mikroscheren
 Micro-Tijeras
 Micro-Ciseaux
 Micro-Forbici

Micro Coronary Scissor
 Fine Blades, Round Handle



Catalog #	Size, Profile
SS-755-25	16.5 cm (6 1/2"), Angled 25°
SS-755-45	16.5 cm (6 1/2"), Angled 45°
SS-755-60	16.5 cm (6 1/2"), Angled 60°
SS-755-90	16.5 cm (6 1/2"), Angled 90°
SS-777-00	16.5 cm (6 1/2"), Angled 125°

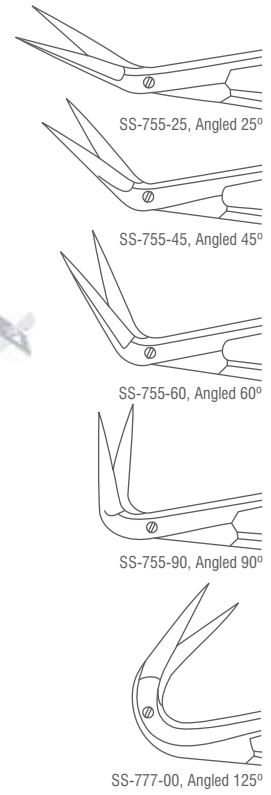

Micro Coronary Scissor
 Fine Blades, One Blade with Probe Tip, Round Handle



Catalog #	Size, Profile
SS-779-25	16.5 cm (6 1/2"), Angled 25°
SS-779-45	16.5 cm (6 1/2"), Angled 45°
SS-779-60	16.5 cm (6 1/2"), Angled 60°
SS-779-90	16.5 cm (6 1/2"), Angled 90°
SS-781-00	16.5 cm (6 1/2"), Angled 125°

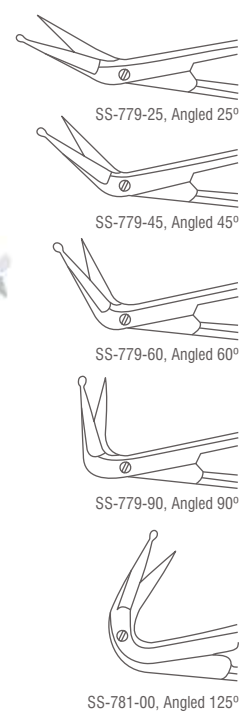

Micro Scissors
Mikroscheren
Micro-Tijeras
Micro-Ciseaux
Micro-Forbici

SS

SCISSORS

Micro Coronary Scissor
Delicate Blades, Round Handle



Catalog #	Size, Profile
SS-783-25	16.5 cm (6 1/2"), Angled 25°
SS-783-45	16.5 cm (6 1/2"), Angled 45°
SS-783-60	16.5 cm (6 1/2"), Angled 60°
SS-783-90	16.5 cm (6 1/2"), Angled 90°
SS-785-00	16.5 cm (6 1/2"), Angled 125°

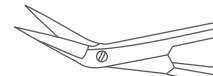

SS-783-25, Angled 25°



SS-783-45, Angled 45°



SS-783-60, Angled 60°



SS-783-90, Angled 90°



SS-785-00, Angled 125°

Micro Coronary Scissor
Extra Delicate Blades, Round Handle



Catalog #	Size, Profile
SS-787-25	16.5 cm (6 1/2"), Angled 25°
SS-787-45	16.5 cm (6 1/2"), Angled 45°
SS-787-60	16.5 cm (6 1/2"), Angled 60°
SS-787-90	16.5 cm (6 1/2"), Angled 90°
SS-789-00	16.5 cm (6 1/2"), Angled 125°

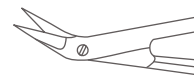

SS-787-25, Angled 25°



SS-787-45, Angled 45°



SS-787-60, Angled 60°

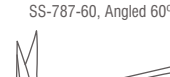

SS-787-90, Angled 90°



SS-789-00, Angled 125°

Micro Scissors
 Mikroscheren
 Micro-Tijeras
 Micro-Ciseaux
 Micro-Forbici

Micro Scissor
 Straight, Round Handle



Catalog #	Size
SS-790-18	18 cm (7")

Micro Scissor
 Curved, Round Handle



Catalog #	Size
SS-791-18	18 cm (7")

Micro Scissor
 Curved, One Blade with Probe Tip, Round Handle



Catalog #	Size
SS-793-18	18 cm (7")

Micro Suture Cutting Scissor
 Straight, One Toothed Cutting Edge, Round Handle



Catalog #	Size
SS-796-18	18 cm (7")

Micro Scissor
 Straight, Round Handle



Catalog #	Size, Blade Size
SS-800-15	15 cm (6"), 10 mm
SS-800-18	18 cm (7"), 10 mm
SS-800-21	21 cm (8 1/4"), 10 mm
SS-800-23	23 cm (9"), 10 mm

Micro Scissors
Mikroscheren
Micro-Tijeras
Micro-Ciseaux
Micro-Forbici

SS

SCISSORS

Micro Scissor

Straight, Round Handle, Titanium

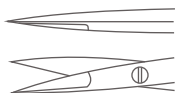

Catalog #	Size, Blade Size
SS-800-15 T	15 cm (6"), 10 mm
SS-800-18 T	18 cm (7"), 10 mm
SS-800-21 T	21 cm (8 1/4"), 10 mm

Micro Scissor

Curved, Round Handle

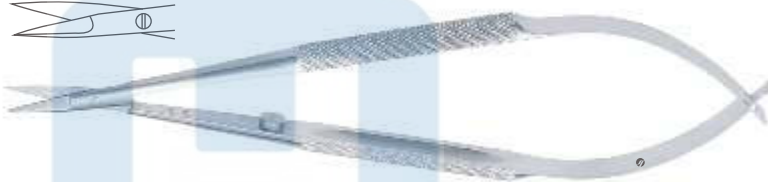
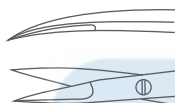

Catalog #	Size, Blade Size
SS-801-15	15 cm (6"), 10 mm
SS-801-18	18 cm (7"), 10 mm
SS-801-21	21 cm (8 1/4"), 10 mm
SS-801-23	23 cm (9"), 10 mm

Micro Scissor

Curved, Round Handle, Titanium

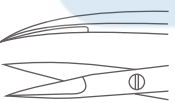

Catalog #	Size, Blade Size
SS-801-15 T	15 cm (6"), 10 mm
SS-801-18 T	18 cm (7"), 10 mm
SS-801-21 T	21 cm (8 1/4"), 10 mm

Micro Scissor

Straight, Flat Handle



Catalog #	Size, Blade Size
SS-804-15	15 cm (6"), 10 mm
SS-804-18	18 cm (7"), 10 mm
SS-804-21	21 cm (8 1/4"), 10 mm
SS-804-23	23 cm (9"), 10 mm

Micro Scissors
 Mikroscheren
 Micro-Tijeras
 Micro-Ciseaux
 Micro-Forbici

Micro Scissor
 Straight, Flat Handle, Titanium

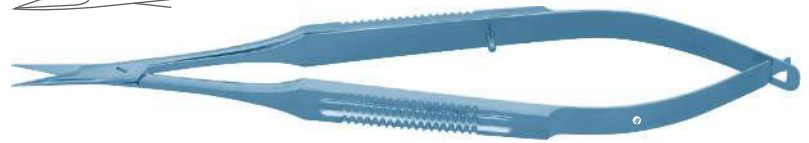

Catalog #	Size, Blade Size
SS-804-15 T	15 cm (6"), 10 mm
SS-804-18 T	18 cm (7"), 10 mm
SS-804-21 T	21 cm (8 1/4"), 10 mm

Micro Scissor
 Curved, Flat Handle

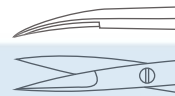

Catalog #	Size, Blade Size
SS-805-15	15 cm (6"), 10 mm
SS-805-18	18 cm (7"), 10 mm
SS-805-21	21 cm (8 1/4"), 10 mm
SS-805-23	23 cm (9"), 10 mm

Micro Scissor
 Curved, Flat Handle, Titanium

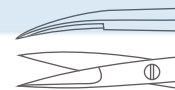

Catalog #	Size, Blade Size
SS-805-15 T	15 cm (6"), 10 mm
SS-805-18 T	18 cm (7"), 10 mm
SS-805-21 T	21 cm (8 1/4"), 10 mm

Jacobson Micro Scissor
 Straight, Bayonet Shaped

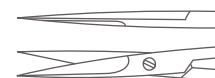

Catalog #	Size
SS-808-23	23 cm (9")

Micro Scissors
 Mikroscheren
 Micro-Tijeras
 Micro-Ciseaux
 Micro-Forbici

Potts Micro Scissor
 Curved, Bayonet Shaped



Catalog #	Size
SS-809-23	23 cm (9")

Micro Scissor
 Straight, Bayonet Shaped



Catalog #	Size
SS-810-23	23 cm (9")

Micro Scissor
 Curved, Bayonet Shaped



Catalog #	Size
SS-811-23	23 cm (9")

Micro Scissor
 Straight, Bayonet Shaped



Catalog #	Size
SS-814-19	18.5 cm (7 1/4")

Micro Scissor
 Curved, Bayonet Shaped



Catalog #	Size
SS-815-19	18.5 cm (7 1/4")

Micro Scissors
 Mikroscheren
 Micro-Tijeras
 Micro-Ciseaux
 Micro-Forbici

Micro Scissor
 Straight, Bayonet Shaped

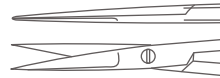

Catalog #	Size
SS-816-19	19 cm (7 1/2")
SS-816-21	21.5 cm (8 1/2")

Micro Scissor
 Curved Downwards, Bayonet Shaped

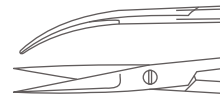

Catalog #	Size
SS-817-19	18.5 cm (7 1/4")
SS-817-21	21.5 cm (8 1/2")

Micro Scissor
 Curved Upwards, Bayonet Shaped

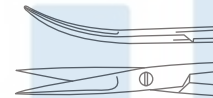

Catalog #	Size
SS-819-19	18.5 cm (7 1/4")
SS-819-21	21.5 cm (8 1/2")

Jaboma Micro Scissor
 Angled, One Blade Probe Tip

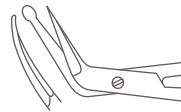

Catalog #	Size, Blade Size
SS-825-18	18 cm (7"), 12 mm

Jaboma Micro Scissor
 Angled, One Blade Probe Tip

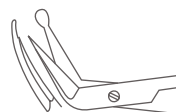

Catalog #	Size, Blade Size
SS-827-18	18 cm (7"), 12 mm

Micro Scissors
Mikroscheren
Micro-Tijeras
Micro-Ciseaux
Micro-Forbici

Jaboma Micro Scissor (For Cleft Palate)
Angled

Catalog #	Size, Blade Size
SS-829-18	18 cm (7"), 12 mm



Operating Scissors
 Chirurgische Scheren
 Tijeras quirúrgicas
 Ciseaux chirurgicaux
 Forbici per chirurgia

UltraCut™ TC Operating Scissor
 Straight, Blunt/Blunt

ULTRA.Cut™

Catalog #	Size
SS-850-14	14.5 cm (5 ¾")

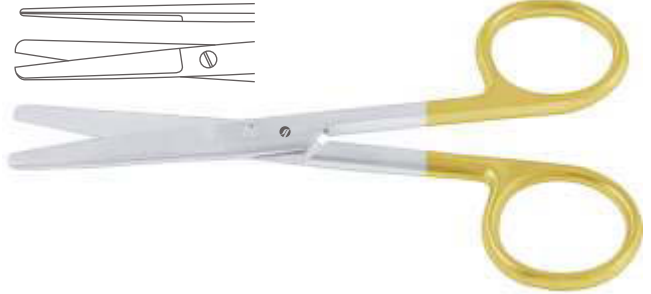

UltraCut™ TC Operating Scissor
 Curved, Blunt/Blunt

ULTRA.Cut™

Catalog #	Size
SS-851-14	14.5 cm (5 ¾")

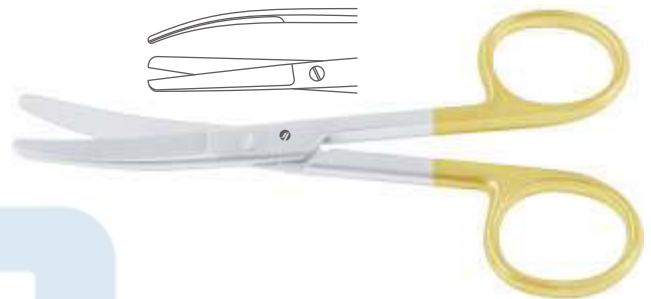

UltraCut™ TC Operating Scissor
 Straight, Sharp/Blunt

ULTRA.Cut™

Catalog #	Size
SS-852-14	14.5 cm (5 ¾")



XTSCut™ TC Operating Scissor
 Straight, Sharp/Blunt

XTS Cut™

Catalog #	Size
SS-852-14 SC	14.5 cm (5 ¾")



UltraCut™ TC Operating Scissor
 Curved, Sharp/Blunt

ULTRA.Cut™

Catalog #	Size
SS-853-14	14.5 cm (5 ¾")



Operating Scissors
Chirurgische Scheren
Tijeras quirúrgicas
Ciseaux chirurgicaux
Forbici per chirurgia

XTSCut™ TC Operating Scissor
Curved, Sharp/Blunt



Catalog #	Size
SS-853-14 SC	14.5 cm (5 ¾")

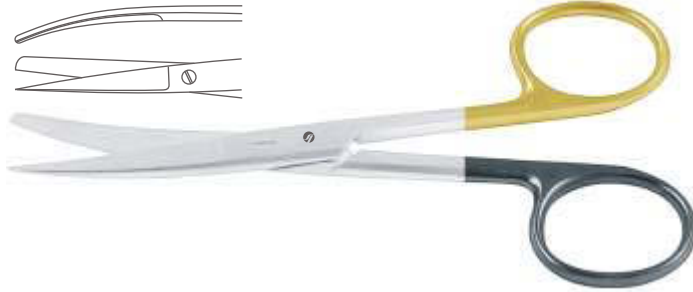

UltraCut™ TC Operating Scissor
Straight, Sharp/Sharp



Catalog #	Size
SS-854-14	14.5 cm (5 ¾")



UltraCut™ TC Operating Scissor
Curved, Sharp/Sharp



Catalog #	Size
SS-855-14	14.5 cm (5 ¾")

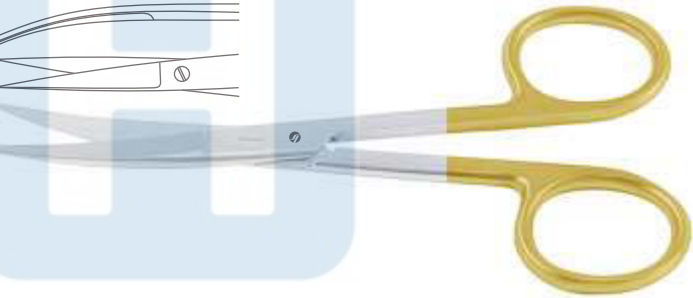

UltraCut™ TC Mayo Dissecting Scissor
Straight



Catalog #	Size
SS-860-14	14.5 cm (5 ¾")
SS-860-17	17 cm (6 ¾")
SS-860-23	23 cm (9")



XTSCut™ TC Mayo Dissecting Scissor
Straight



Catalog #	Size
SS-860-14 SC	14.5 cm (5 ¾")
SS-860-17 SC	17 cm (6 ¾")
SS-860-23 SC	23 cm (9")



Operating Scissors
Chirurgische Scheren
Tijeras quirúrgicas
Ciseaux chirurgicaux
Forbici per chirurgia

UltraCut™ TC Mayo Dissecting Scissor
Curved

ULTRA *Cut™*

Catalog #	Size
SS-861-14	14.5 cm (5 ¾")
SS-861-17	17 cm (6 ¾")
SS-861-23	23 cm (9")



XTSCut™ TC Mayo Dissecting Scissor
Curved

XTS *Cut™*

Catalog #	Size
SS-861-14 SC	14.5 cm (5 ¾")
SS-861-17 SC	17 cm (6 ¾")
SS-861-23 SC	23 cm (9")



UltraCut™ TC Mayo-Stille Dissecting Scissor
Straight

ULTRA *Cut™*

Catalog #	Size
SS-890-15	15 cm (6")
SS-890-17	17 cm (6 ¾")



XTSCut™ TC Mayo-Stille Dissecting Scissor
Straight

XTS *Cut™*

Catalog #	Size
SS-890-15 SC	15 cm (6")
SS-890-17 SC	17 cm (6 ¾")



Operating Scissors
Chirurgische Scheren
Tijeras quirúrgicas
Ciseaux chirurgicaux
Forbici per chirurgia

UltraCut™ TC Mayo-Stille Dissecting Scissor
Curved

ULTRACut™

Catalog #	Size
SS-891-15	15 cm (6")
SS-891-17	17 cm (6 ¾")



XTSCut™ TC Mayo-Stille Dissecting Scissor
Curved

XTSCut™

Catalog #	Size
SS-891-15 SC	15 cm (6")
SS-891-17 SC	17 cm (6 ¾")

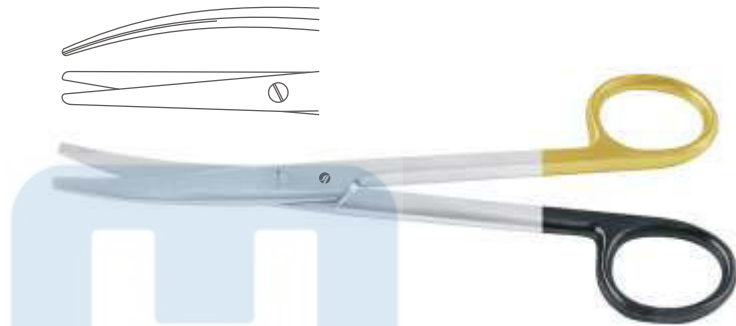

UltraCut™ TC Metzenbaum Dissecting Scissor
Straight

ULTRACut™

Catalog #	Size
SS-900-11	11.5 cm (4 ½")



UltraCut™ TC Metzenbaum Dissecting Scissor
Curved

ULTRACut™

Catalog #	Size
SS-901-11	11.5 cm (4 ½")



UltraCut™ TC Metzenbaum Dissecting Scissor
Straight

ULTRACut™

Catalog #	Size
SS-902-14	14.5 cm (5 ¾")



Operating Scissors
 Chirurgische Scheren
 Tijeras quirúrgicas
 Ciseaux chirurgicaux
 Forbici per chirurgia

XTSCut™ TC Metzenbaum Dissecting Scissor
 Straight



Catalog #	Size
SS-902-14 SC	14.5 cm (5 ¾")



UltraCut™ TC Metzenbaum Dissecting Scissor
 Curved



Catalog #	Size
SS-903-14	14.5 cm (5 ¾")



XTSCut™ TC Metzenbaum Dissecting Scissor
 Curved



Catalog #	Size
SS-903-14 SC	14.5 cm (5 ¾")



UltraCut™ TC Metzenbaum Dissecting Scissor
 Straight



Catalog #	Size
SS-904-18	18 cm (7")
SS-904-20	20.5 cm (8")
SS-904-23	23 cm (9")
SS-904-25	26 cm (10 ¼")
SS-904-28	28.5 cm (11 ¼")
SS-904-30	31 cm (12 ¼")



Operating Scissors
Chirurgische Scheren
Tijeras quirúrgicas
Ciseaux chirurgicaux
Forbici per chirurgia

XTSCut™ TC Metzenbaum Dissecting Scissor
Straight



Catalog #	Size
SS-904-18 SC	18 cm (7")
SS-904-20 SC	20.5 cm (8")
SS-904-23 SC	23 cm (9")



UltraCut™ TC Metzenbaum Dissecting Scissor
Curved



Catalog #	Size
SS-905-18	18 cm (7")
SS-905-20	20.5 cm (8")
SS-905-23	23 cm (9")
SS-905-25	26 cm (10 1/4")
SS-905-28	28.5 cm (11 1/4")
SS-905-30	31 cm (12 1/4")

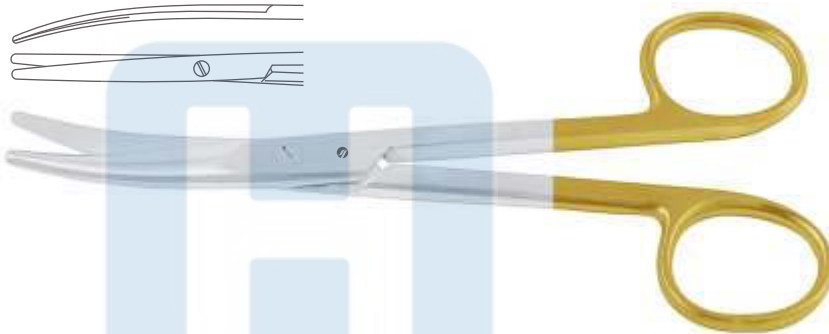

XTSCut™ TC Metzenbaum Dissecting Scissor
Curved



Catalog #	Size
SS-905-18 SC	18 cm (7")
SS-905-20 SC	20.5 cm (8")
SS-905-23 SC	23 cm (9")



UltraCut™ TC Metzenbaum -Thorek Dissecting Scissor
Curved



Catalog #	Size
SS-907-20	20 cm (8")
SS-907-23	23 cm (9")
SS-907-28	28 cm (11")



Operating Scissors, Dissecting Scissors
 Chirurgische Scheren, Präparierscheren
 Tijeras quirúrgicas, Tijeras de disección
 Ciseaux chirurgicaux, Ciseaux à dissection
 Forbici per chirurgia, Forbici per dissezione

UltraCut™ TC Joseph Dissecting Scissor
 Straight

ULTRACut™

Catalog #	Size
SS-910-14	14.5 cm (5 3/4")

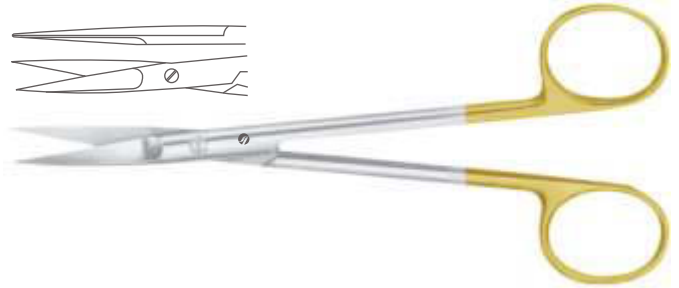

UltraCut™ TC Joseph Dissecting Scissor
 Curved

ULTRACut™

Catalog #	Size
SS-911-14	14.5 cm (5 3/4")

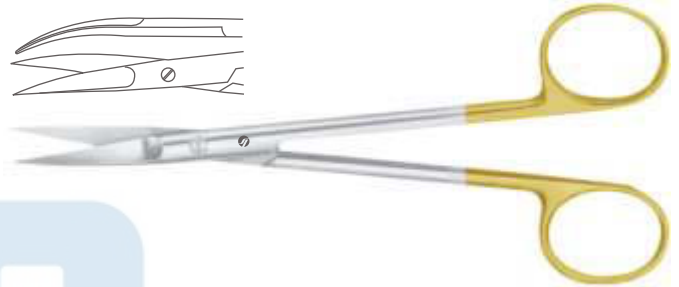

UltraCut™ TC Lexer Dissecting Scissor
 Straight

ULTRACut™

Catalog #	Size
SS-914-16	16 cm (6 1/4")
SS-914-21	21 cm (8 1/4")

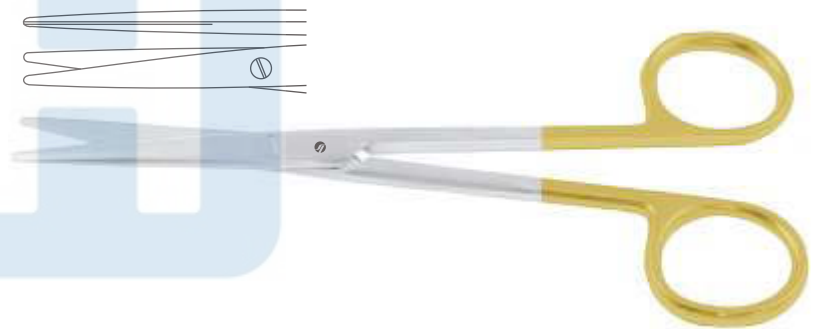

XTSCut™ TC Lexer Dissecting Scissor
 Straight

XTS Cut™

Catalog #	Size
SS-914-16 SC	16 cm (6 1/4")



UltraCut™ TC Lexer Dissecting Scissor
 Curved

ULTRACut™

Catalog #	Size
SS-915-16	16 cm (6 1/4")
SS-915-21	21 cm (8 1/4")



Operating Scissors, Dissecting Scissors
 Chirurgische Scheren, Präparierscheren
 Tijeras quirúrgicas, Tijeras de disección
 Ciseaux chirurgicaux, Ciseaux à dissection
 Forbici per chirurgia, Forbici per dissezione

XTSCut™ TC Lexer Dissecting Scissor
 Curved



Catalog #	Size
SS-915-16 SC	16 cm (6 1/4")



UltraCut™ TC Mayo-Lexer Dissecting Scissor
 Curved



Catalog #	Size
SS-917-16	16 cm (6 1/4")



UltraCut™ TC Metzenbaum-Fine Delicate Dissecting Scissor
 Straight, Slender Pattern



Catalog #	Size
SS-920-14	14.5 cm (5 3/4")

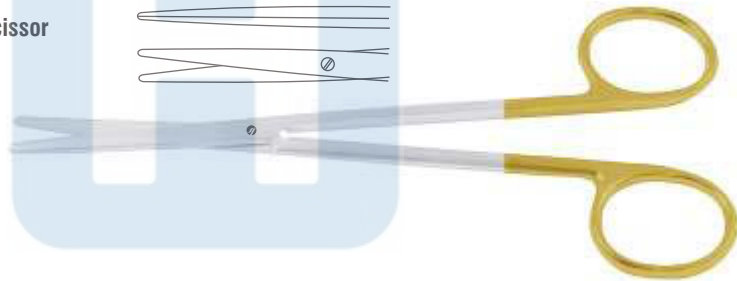

XTSCut™ TC Metzenbaum-Fine Delicate Dissecting Scissor
 Straight, Slender Pattern



Catalog #	Size
SS-920-14 SC	14.5 cm (5 3/4")



UltraCut™ TC Metzenbaum-Fine Delicate Dissecting Scissor
 Curved, Slender Pattern



Catalog #	Size
SS-921-14	14.5 cm (5 3/4")

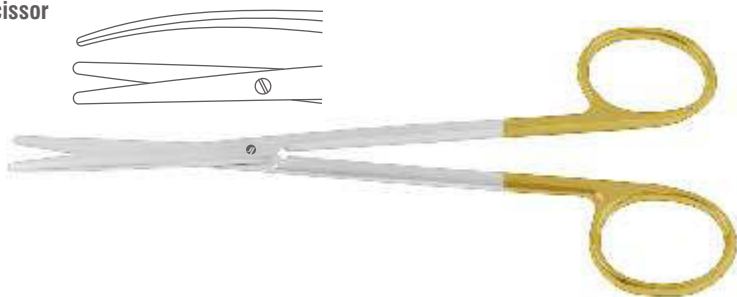

Delicate Dissecting Scissors
 Feine Präparierscheren
 Tijeras finas de disección
 Ciseaux fins à dissection
 Forbici fini per dissezione

XTSCut™ TC Metzenbaum-Fine Delicate Dissecting Scissor
 Curved, Slender Pattern



Catalog #	Size
SS-921-14 SC	14.5 cm (5 ¾")



UltraCut™ TC Metzenbaum-Fine Delicate Dissecting Scissor
 Straight, Slender Pattern



Catalog #	Size
SS-922-18	18 cm (7")
SS-922-20	20.5 cm (8")
SS-922-23	23 cm (9")
SS-922-25	25 cm (9 ¾")
SS-922-28	28 cm (11")

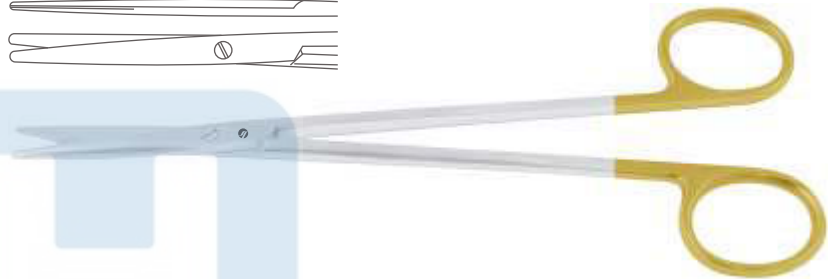

XTSCut™ TC Metzenbaum-Fine Delicate Dissecting Scissor
 Straight, Slender Pattern



Catalog #	Size
SS-922-18 SC	18 cm (7")
SS-922-20 SC	20.5 cm (8")
SS-922-23 SC	23 cm (9")

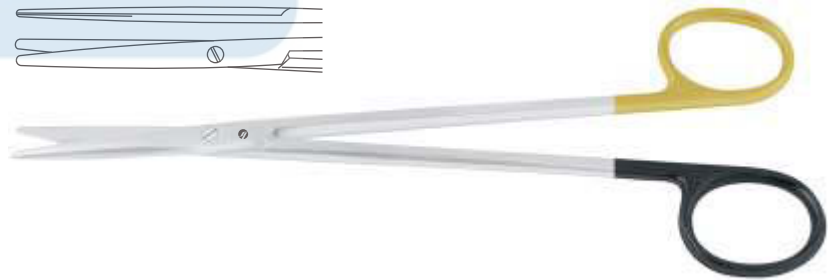

UltraCut™ TC Metzenbaum-Fine Delicate Dissecting Scissor
 Curved, Slender Pattern



Catalog #	Size
SS-923-18	18 cm (7")
SS-923-20	20.5 cm (8")
SS-923-23	23 cm (9")
SS-923-25	25 cm (9 ¾")
SS-923-28	28.5 cm (11 ¼")

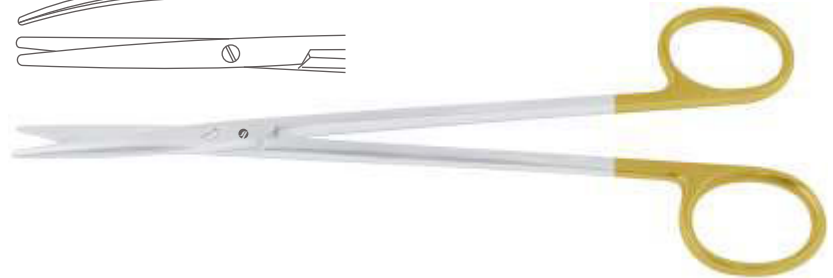

Delicate Dissecting Scissors
 Feine Präparierscheren
 Tijeras finas de disección
 Ciseaux fins à dissection
 Forbici fini per dissezione

XTSCut™ TC Metzenbaum-Fine Delicate Dissecting Scissor
 Curved, Slender Pattern

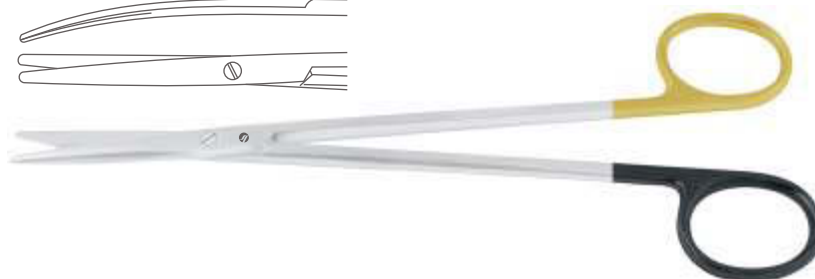
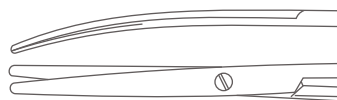

Catalog #	Size
SS-923-18 SC	18 cm (7")
SS-923-20 SC	20.5 cm (8")
SS-923-23 SC	23 cm (9")

UltraCut™ TC Metzenbaum-Fine Delicate Dissecting Scissor
 Straight, Sharp

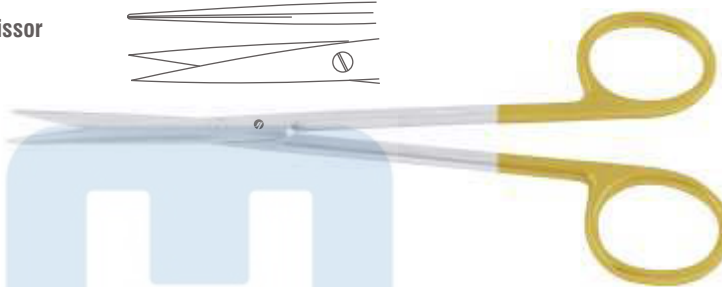

Catalog #	Size
SS-926-14	14.5 cm (5 3/4")

UltraCut™ TC Metzenbaum-Fine Delicate Dissecting Scissor
 Curved, Sharp

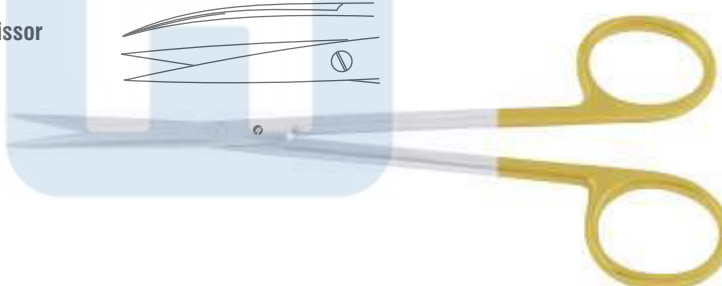
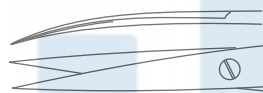

Catalog #	Size
SS-927-14	14.5 cm (5 3/4")

UltraCut™ TC Metzenbaum-Fine Delicate Dissecting Scissor
 Straight, Sharp

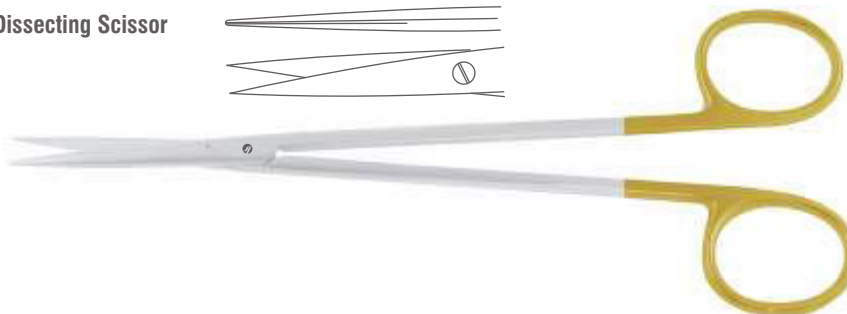
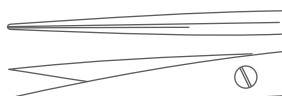

Catalog #	Size
SS-928-18	18 cm (7")
SS-928-20	20 cm (8")

UltraCut™ TC Metzenbaum-Lahey Dissecting Scissor
 Curved, Slender Pattern

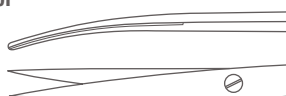

Catalog #	Size
SS-931-14	14.5 cm (5 3/4")

Delicate Dissecting Scissors, Nasal Scissors
 Feine Präparierscheren, Nasenscheren
 Tijeras finas de disección, Tijeras nasales
 Ciseaux fins à dissection, Ciseaux nasaux
 Forbici fini per dissezione, Forbici nasali

UltraCut™ TC Toennis-Adson Dissecting Scissor
 Curved, Slender Pattern

ULTRA.Cut™

Catalog #	Size
SS-933-17	17.5 cm (7")



UltraCut™ TC Metzenbaum-Lahey Dissecting Scissor
 Curved, Slender Pattern

ULTRA.Cut™

Catalog #	Size
SS-935-20	20.5 cm (8")
SS-935-23	23 cm (9")

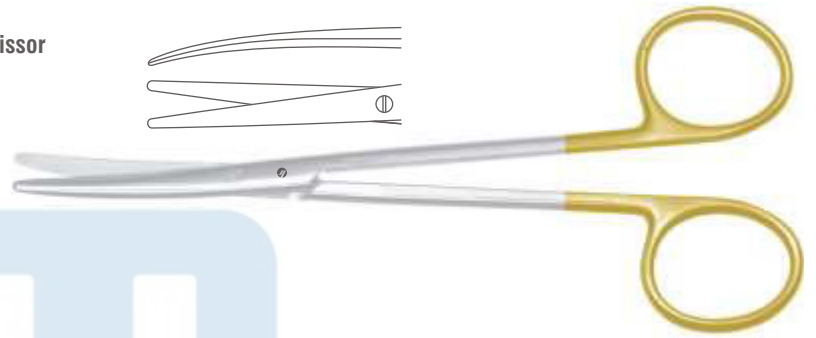
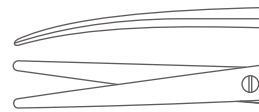

UltraCut™ TC Metzenbaum-Fine Delicate Dissecting Scissor
 Curved, S Shaped, Slender Pattern

ULTRA.Cut™

Catalog #	Size
SS-937-18	18 cm (7")
SS-937-20	20.5 cm (8")
SS-937-23	23 cm (9")

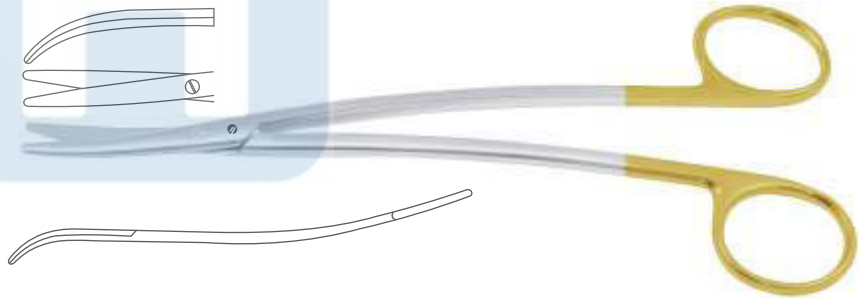
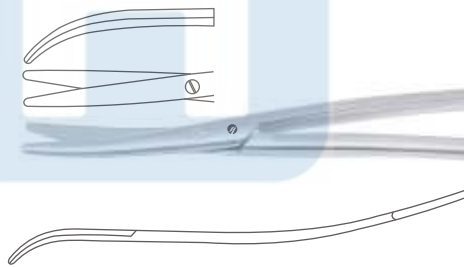

UltraCut™ TC Fomon Nasal Scissor

ULTRA.Cut™

Catalog #	Size
SS-939-15	14.5 cm (5 3/4")

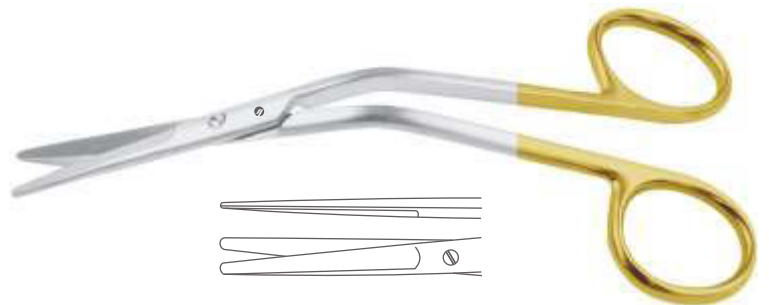

UltraCut™ TC Cottle Nasal Scissor

ULTRA.Cut™

Catalog #	Size
SS-941-16	16 cm (6 1/4")

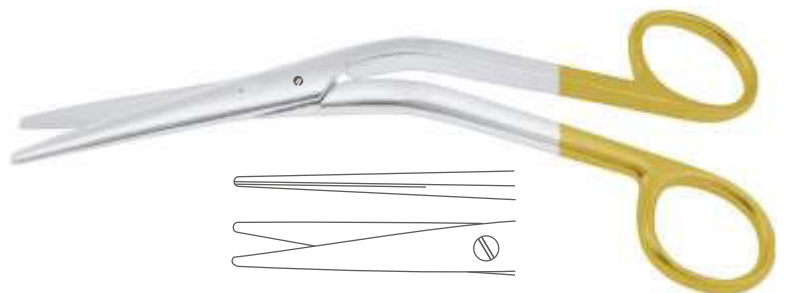
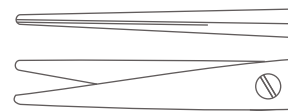

Face-lift Scissors
 Face-lift-Scheren
 Tijeras para Face-Lift
 Ciseaux pour Face-lift
 Forbici per Face-lift

UltraCut™ TC Gorney Face-Lift Scissor
 Straight, One Toothed Cutting Edge

ULTRACut™

Catalog #	Size
SS-944-20	20 cm (8")
SS-944-23	23 cm (9")



UltraCut™ TC Rees Face-Lift Scissor
 Curved, One Toothed Cutting Edge

ULTRACut™

Catalog #	Size
SS-947-17	17 cm (6 3/4")



UltraCut™ TC Gregory Face-Lift Scissor
 One Toothed Cutting Edge

ULTRACut™

Catalog #	Size
SS-949-14	14 cm (5 1/2")

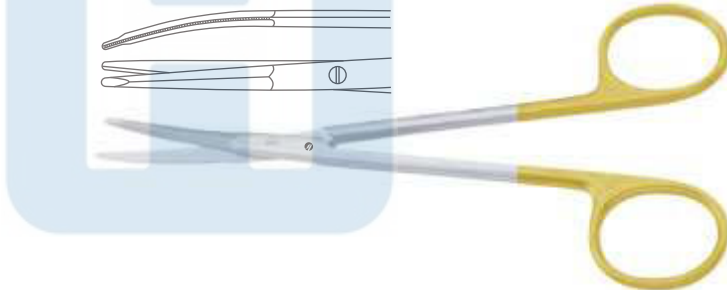

UltraCut™ TC Kaye Face-Lift Scissor
 One Toothed Cutting Edge

ULTRACut™

Catalog #	Size
SS-951-15	15 cm (6")
SS-951-18	18 cm (7")



UltraCut™ TC Stella-S Face-Lift Scissor
 S Shaped, One Toothed Cutting Edge

ULTRACut™

Catalog #	Size
SS-953-18	18 cm (7")



Face-lift Scissors
 Face-lift-Scheren
 Tijeras para Face-Lift
 Ciseaux pour Face-lift
 Forbici per Face-lift

UltraCut™ TC Gorney Face-Lift Scissor
 One Toothed Cutting Edge

ULTRA.Cut™

Catalog #	Size
SS-959-18	18 cm (7")

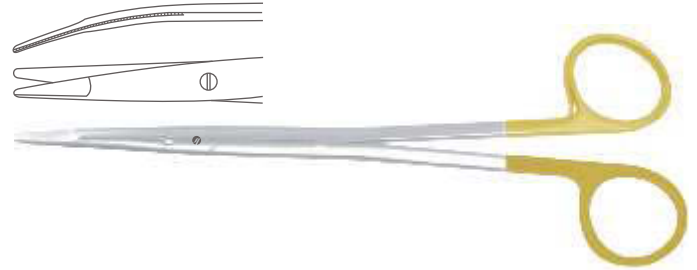

UltraCut™ TC Freeman-Kaye Face-Lift Scissor
 One Toothed Cutting Edge

ULTRA.Cut™

Catalog #	Size
SS-961-18	18 cm (7")
SS-963-23	23 cm (9")

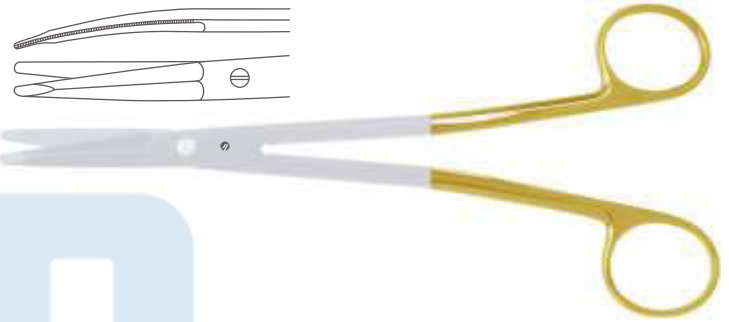

UltraCut™ TC Wertheim Gynecological Scissor
 Curved

ULTRA.Cut™

Catalog #	Size
SS-965-23	23 cm (9")
SS-965-35	35 cm (14")



UltraCut™ TC Sims Gynecological Scissor
 Straight

ULTRA.Cut™

Catalog #	Size
SS-968-23	23 cm (9")



UltraCut™ TC Sims Uterine Scissor
 Curved

ULTRA.Cut™

Catalog #	Size
SS-969-23	23 cm (9")



Hysterectomy Scissors
 Hysterektomiescheren
 Tijeras para histerectomía
 Ciseaux à hystérectomie
 Forbici per isterectomia

UltraCut™ TC Parametrium Hysterectomy Scissor
 Strongly Curved

ULTRACut™

Catalog #	Size
SS-971-01	22.5 cm (8 ¾")



UltraCut™ TC Parametrium Hysterectomy Scissor
 Curved

ULTRACut™

Catalog #	Size
SS-971-02	23 cm (9")



UltraCut™ TC Stevens Tenotomy Scissor
 Straight, Blunt/Blunt

ULTRACut™

Catalog #	Size
SS-972-10	10.5 cm (4 ¼")
SS-972-11	11.5 cm (4 ½")

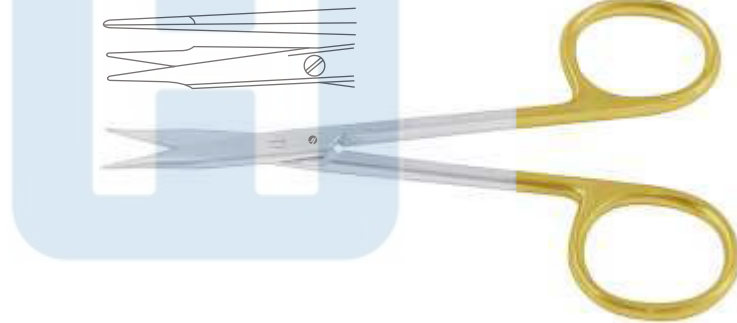

UltraCut™ TC Stevens Tenotomy Scissor
 Curved, Blunt/Blunt

ULTRACut™

Catalog #	Size
SS-973-10	10.5 cm (4 ¼")
SS-973-11	11.5 cm (4 ½")

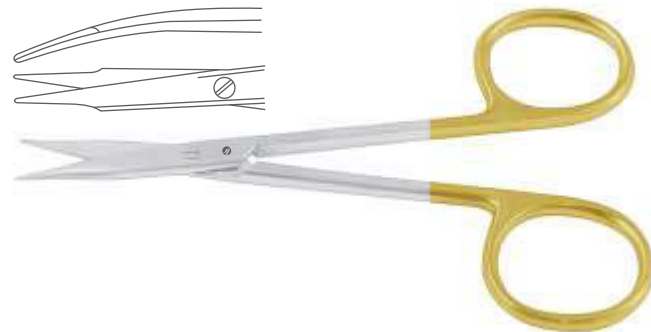

UltraCut™ TC Stevens Tenotomy Scissor
 Straight, Sharp/Sharp

ULTRACut™

Catalog #	Size
SS-974-10	10.5 cm (4 ¼")
SS-974-11	11.5 cm (4 ½")

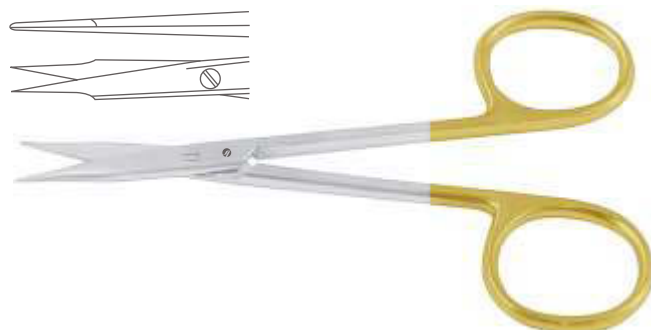

Iris Scissors
 Irisscheren
 Tijeras para iridectomía
 Ciseaux à iridectomie
 Forbici per iridectomia

UltraCut™ TC Stevens Tenotomy Scissor
 Curved, Sharp/Sharp

ULTRA *Cut*[™]

Catalog #	Size
SS-975-10	10.5 cm (4 ¼")
SS-975-11	11.5 cm (4 ½")

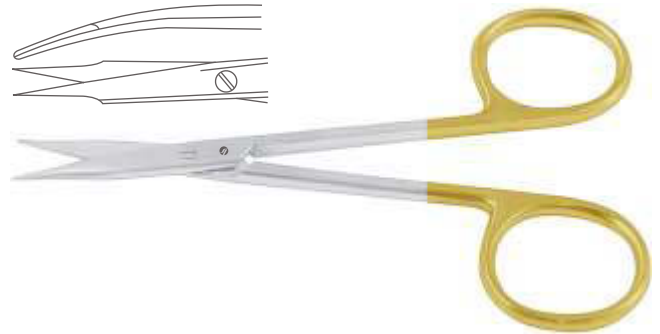

UltraCut™ TC Goldman-Fox Gum Scissor
 Straight

ULTRA *Cut*[™]

Catalog #	Size
SS-976-13	13 cm (5")



UltraCut™ TC Goldman-Fox Gum Scissor
 Curved

ULTRA *Cut*[™]

Catalog #	Size
SS-977-13	13 cm (5")



UltraCut™ TC Iris Scissor
 Straight

ULTRA *Cut*[™]

Catalog #	Size
SS-978-11	11.5 cm (4 ½")



XTSCut™ TC Iris Scissor
 Straight

XTS *Cut*[™]

Catalog #	Size
SS-978-11 SC	11.5 cm (4 ½")



Iris Scissors
 Irisscheren
 Tijeras para iridectomia
 Ciseaux à iridectomie
 Forbici per iridectomia

UltraCut™ TC Iris Scissor
 Curved



Catalog #	Size
SS-979-11	11.5 cm (4 1/2")



XTSCut™ TC Iris Scissor
 Curved



Catalog #	Size
SS-979-11 SC	11.5 cm (4 1/2")



UltraCut™ TC DeBakey Vascular Scissor



Catalog #	Size
SS-981-25	19 cm (7 1/2")
SS-981-45	18.5 cm (7 1/4")
SS-981-60	18 cm (7")



Catalog #	Size
SS-983-25	23 cm (9")
SS-983-45	23 cm (9")
SS-983-60	22 cm (8 3/4")

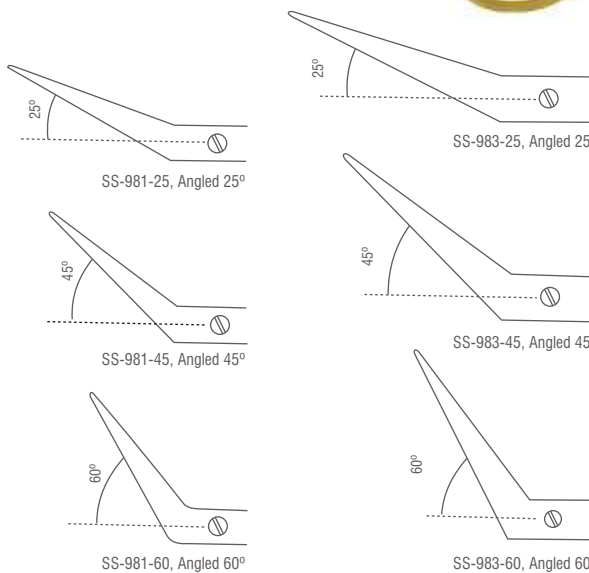

Iris Scissors
 Irisscheren
 Tijeras para iridectomía
 Ciseaux à iridectomie
 Forbici per iridectomia

UltraCut™ TC Iris Scissor
 Angled

ULTRA.Cut™

Catalog #	Size
SS-985-11	11 cm (4 1/2")

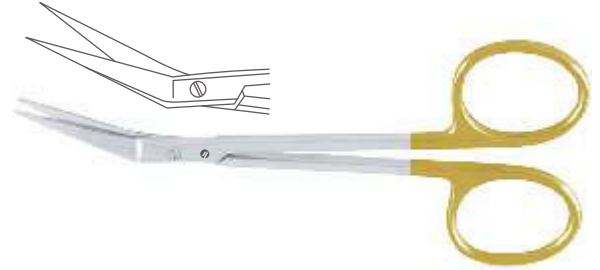

UltraCut™ TC Ragnell (Kilner) Dissecting Scissor
 Curved

ULTRA.Cut™

Catalog #	Size
SS-987-12	12.5 cm (5")
SS-987-15	15 cm (6")
SS-987-18	18 cm (7")

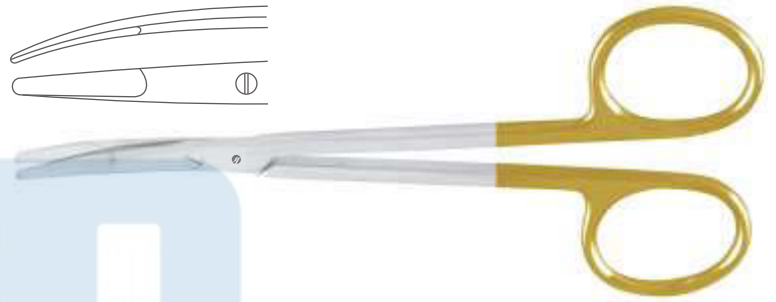
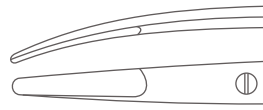

UltraCut™ TC Kelly Dissecting Scissor
 Straight

ULTRA.Cut™

Catalog #	Size
SS-988-16	16 cm (6 1/4")

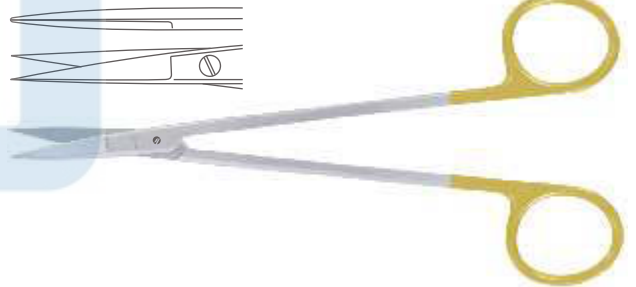
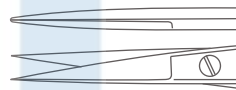

UltraCut™ TC Kelly Dissecting Scissor
 Curved

ULTRA.Cut™

Catalog #	Size
SS-989-16	16 cm (6 1/4")

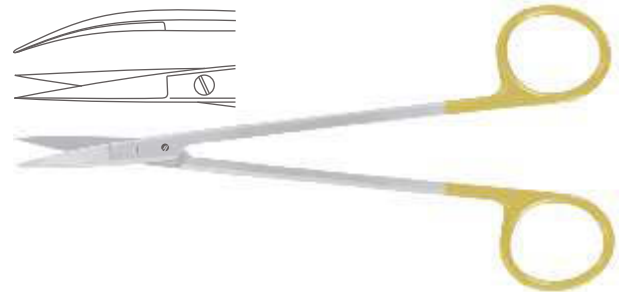
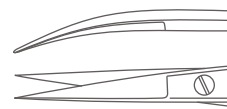

UltraCut™ TC Universal Wire Cutting Scissor
 Angled One Toothed Cutting Edge

ULTRA.Cut™

Catalog #	Size
SS-991-12	12.5 cm (5")

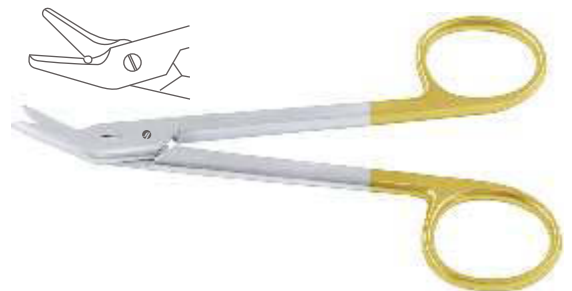
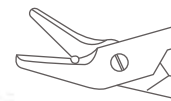

Dissecting Scissors, Gum Scissors
 Präparierscheren, Zahnfleischscheren
 Tijeras de disección, Tijeras para encías
 Ciseaux à dissection, Ciseaux à gencives
 Forbici per dissezione, Forbici per gengiva

UltraCut™ TC Dean Tonsil Scissor
 S Shaped, One Toothed Cutting Edge

ULTRACut™

Catalog #	Size
SS-993-17	17.5 cm (7")

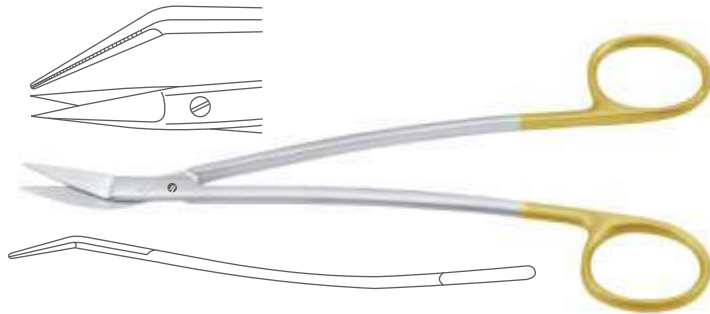

UltraCut™ TC Locklin Gum Scissor
 Angled, One Toothed Cutting Edge

ULTRACut™

Catalog #	Size
SS-995-16	16 cm (6 1/4")



UltraCut™ TC Locklin Gum Scissor
 Angled, S Shaped, One Toothed Cutting Edge

ULTRACut™

Catalog #	Size
SS-997-16	16 cm (6 1/4")



UltraCut™ TC Lister Bandage Scissor
 Angled

ULTRACut™

Catalog #	Size
SS-999-18	18 cm (7")





ALWAYS THE BEST

FR



FORCEPS

Hospita forceps are characterized by their tactile feel and overall balance. At Hospita we realize that our forceps are the extension of the surgeons thumb and forefinger and need to grasp and release with the same sensitivity as real fingertips. Our Master craftsmen with a wealth of experience adjust the spring pressure in order to obtain the tension and feel required to precisely control the instrument without tiring the surgeon's hand

Each aspect of the design for forceps needs to be optimized to ensure perfect handling. The teeth are sharp and durable, shanks designed for feeling balance, handles where required are serrated for perfect grip, spring part is calibrated to offer the surgeon fingertip feeling, instrument junction is precision welded, serrations where required are well-defined for superb grip & perfect alignment and tips are well rounded and smooth



Pinzetten

Pinzas

Pince

Pinze

Dissecting Forceps
 Anatomische Pinzetten
 Pinzas de disección
 Pinces à dissection
 Pinze per dissezione

Standard Pattern Dressing Forcep
 Straight, Serrated

Catalog #	Size
FR-010-10	10.5 cm (4 1/4")
FR-010-11	11.5 cm (4 1/2")
FR-010-13	13 cm (5")
FR-010-14	14.5 cm (5 3/4")
FR-010-16	16 cm (6 1/4")
FR-010-18	18 cm (7")
FR-010-20	20 cm (8")
FR-010-23	23 cm (9")
FR-010-25	25 cm (9 3/4")
FR-010-30	30.5 cm (12")



Slender Pattern Dressing Forcep
 Straight, Serrated

Catalog #	Size
FR-012-11	12 cm (4 3/4")
FR-012-13	13 cm (5")
FR-012-14	14.5 cm (5 3/4")
FR-012-16	16 cm (6 1/4")
FR-012-18	18 cm (7")
FR-012-20	20 cm (8")
FR-012-25	25 cm (9 3/4")
FR-012-30	30 cm (11 3/4")



Slender Pattern Dressing Forcep
 Curved, Serrated

Catalog #	Size
FR-013-13	13 cm (5")
FR-013-14	14 cm (5 1/2")

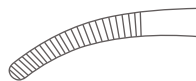

Dissecting Forceps
Anatomische Pinzetten
Pinzas de disección
Pinces à dissection
Pinze per dissezione

Fine Pattern Dressing Forcep
Curved, Serrated

Catalog #	Size
FR-016-13	13 cm (5")
FR-016-14	14.5 cm (5 ¾")
FR-016-16	16 cm (6 ¼")
FR-016-18	18 cm (7")



Modell. USA Dressing Forcep
Straight, Serrated

Catalog #	Size
FR-020-12	12 cm (4 ¾")
FR-020-13	13 cm (5")
FR-020-14	14.5 cm (5 ¾")
FR-020-16	16 cm (6 ¼")
FR-020-18	18 cm (7")
FR-020-20	20 cm (8")
FR-020-23	23 cm (9")
FR-020-25	25 cm (9 ¾")
FR-020-30	30 cm (11 ¾")



Modell. USA Slender Pattern Dressing Forcep
Straight, Serrated

Catalog #	Size
FR-022-12	12 cm (4 ¾")
FR-022-13	13 cm (5")
FR-022-14	14.5 cm (5 ¾")
FR-022-16	16 cm (6 ¼")



Stille Dressing Forcep
Round Tips

Catalog #	Size
FR-030-15	15 cm (6")



Dissecting Forceps
 Anatomische Pinzetten
 Pinzas de disección
 Pinces à dissection
 Pinze per dissezione

Stille Dressing Forcep
 Square Tips

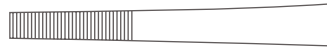

Catalog #	Size
FR-035-15	15 cm (6")
FR-035-17	17 cm (6 3/4")
FR-035-20	20 cm (8")

Adson Dressing Forcep

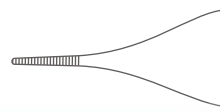

Catalog #	Size
FR-050-12	12 cm (4 3/4")
FR-050-15	15 cm (6")

Mini Adson Dressing Forcep
 Cross Serrated Tips

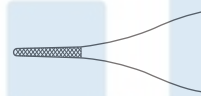

Catalog #	Size
FR-052-12	12 cm (4 3/4")

Micro Adson Dressing Forcep

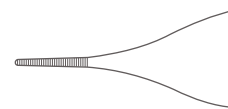

Catalog #	Size
FR-054-12	12 cm (4 3/4")
FR-054-15	15 cm (6")

McIndoe Dressing Forcep



Catalog #	Size
FR-060-15	15 cm (6")

INCHES
 MILLIMETERS

Dissecting Forceps
Anatomische Pinzetten
Pinzas de disección
Pinces à dissection
Pinze per dissezione

Semken Dressing Forcep



Catalog #	Size
FR-070-12	12.5 cm (5")
FR-070-15	15 cm (6")

Taylor Dressing Forcep



Catalog #	Size
FR-074-17	17 cm (6 3/4")

Taylor Dressing Forcep With Dissector End



Catalog #	Size
FR-076-17	17 cm (6 3/4")

Taylor Dressing Forcep Bayonet Shaped, With Dissector End



Catalog #	Size
FR-078-17	18.5 cm (7 1/4")

Turner Micro Dressing Forcep



Catalog #	Size
FR-080-06	15.5 cm (6"), 0.6 mm
FR-080-08	15.5 cm (6"), 0.8 mm
FR-080-10	15.5 cm (6"), 1.0 mm

Dissecting Forceps
 Anatomische Pinzetten
 Pinzas de disección
 Pinces à dissection
 Pinze per dissezione

Gerald Dressing Forcep
 Straight



Catalog #	Size
FR-084-17	17.5 cm (7")
FR-084-23	23 cm (9")

Gerald Dressing Forcep
 Curved

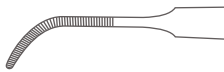

Catalog #	Size
FR-085-17	17.5 cm (7")

Cushing Dressing Forcep
 Straight



Catalog #	Size
FR-090-17	17.5 cm (7")
FR-090-20	20 cm (8")
FR-090-25	25 cm (9 3/4")

Cushing Dressing Forcep
 Curved

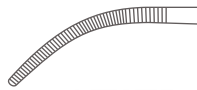

Catalog #	Size
FR-091-17	17.5 cm (7")

Potts-Smith Dressing Forcep



Catalog #	Size
FR-094-18	18 cm (7")
FR-094-21	21 cm (8 1/4")
FR-094-25	24.5 (9 3/4")
FR-094-30	30 cm (11 3/4")

Dissecting Forceps
Anatomische Pinzetten
Pinzas de disección
Pinces à dissection
Pinze per dissezione

Dressing Forcep



Catalog #	Size
FR-096-15	15.5 cm (6")

Gillies Dressing Forcep



Catalog #	Size
FR-100-15	15 cm (6")

Waugh Dressing Forcep
Cross Serrated



Catalog #	Size
FR-102-20	20 cm (8")

Brophy Dressing Forcep
Straight



Catalog #	Size
FR-104-20	20 cm (8")

Brophy Dressing Forcep
Curved



Catalog #	Size
FR-105-20	20 cm (8")

Dissecting Forceps
 Anatomische Pinzetten
 Pinzas de disección
 Pinces à dissection
 Pinze per dissezione

Cooley Dressing Forcep
 Cross Serrated Jaws



Catalog #	Size
FR-108-20	20 cm (8")

Dressing Forcep
 Angled



Catalog #	Size
FR-111-20	20 cm (8")

Ochsner Dressing Forcep
 Longitudinal Serrations



Catalog #	Size
FR-114-14	14.5 cm (5 3/4")

Bonney Dressing Forcep

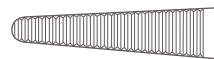

Catalog #	Size
FR-116-17	17.5 cm (7")

Ramsey Dressing Forcep

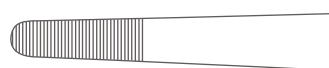

Catalog #	Size
FR-118-18	18 cm (7")

INCHES
 MILLIMETERS

Dissecting Forceps
Anatomische Pinzetten
Pinzas de disección
Pinces à dissection
Pinze per dissezione

Standard Pattern Dissecting Forcep
Straight, 1 x 2 Teeth

Catalog #	Size
FR-200-10	10.5 cm (4 1/4")
FR-200-11	11.5 cm (4 1/2")
FR-200-13	13 cm (5")
FR-200-14	14.5 cm (5 3/4")
FR-200-16	16 cm (6 1/4")
FR-200-18	18 cm (7")
FR-200-20	20 cm (8")
FR-200-23	23 cm (9")
FR-200-25	25 cm (9 3/4")
FR-200-30	30.5 cm (12")



Standard Pattern Dissecting Forcep
Straight, 2 x 3 Teeth

Catalog #	Size
FR-202-11	12 cm (4 3/4")
FR-202-13	13 cm (5")
FR-202-14	14.5 cm (5 3/4")
FR-202-16	15.5 cm (6")
FR-202-18	18 cm (7")
FR-202-20	20 cm (8")
FR-202-25	24.5 cm (9 3/4")



Standard Pattern Dissecting Forcep
Straight, 3 x 4 Teeth

Catalog #	Size
FR-204-14	14.5 cm (5 3/4")
FR-204-16	16 cm (6 1/4")



Dissecting Forceps
 Anatomische Pinzetten
 Pinzas de disección
 Pinces à dissection
 Pinze per dissezione

Standard Pattern Dissecting Forcep
 Straight, 4 x 5 Teeth



Catalog #	Size
FR-206-14	14.5 cm (5 3/4")
FR-206-16	16 cm (6 1/4")

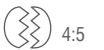

Slender Pattern Dissecting Forcep
 Straight, 1 x 2 Teeth



Catalog #	Size
FR-210-13	13 cm (5")
FR-210-14	14.5 cm (5 3/4")
FR-210-16	16 cm (6 1/4")
FR-210-18	18 cm (7")
FR-210-20	20 cm (8")
FR-210-25	25 cm (9 3/4")
FR-210-30	30.5 cm (12")



Slender Pattern Dissecting Forcep
 Curved, 1 x 2 Teeth



Catalog #	Size
FR-211-14	14.5 cm (5 3/4")



Fine Pattern Dissecting Forcep
 1 x 2 Teeth

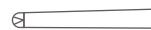

Catalog #	Size
FR-214-13	13 cm (5 3/4")
FR-214-14	14.5 cm (5 3/4")
FR-214-16	16 cm (6 1/4")
FR-214-18	18 cm (7")



Dissecting Forceps
Anatomische Pinzetten
Pinzas de disección
Pincas à dissection
Pinze per dissezione

Modell. USA Dissecting Forcep
1 x 2 Teeth

Catalog #	Size
FR-220-12	12 cm (4 ¾")
FR-220-13	13 cm (5")
FR-220-14	14.5 cm (5 ¾")
FR-220-16	16 cm (6 ¼")
FR-220-18	18 cm (7")
FR-220-20	20 cm (8")
FR-220-23	23 cm (9")
FR-220-25	25 cm (9 ¾")
FR-220-30	30 cm (11 ¾")



Modell. USA Dissecting Forcep
2 x 3 Teeth

Catalog #	Size
FR-222-12	12 cm (4 ¾")
FR-222-13	13 cm (5")
FR-222-14	14.5 cm (5 ¾")
FR-222-16	16 cm (6 ¼")
FR-222-18	18 cm (7")
FR-222-20	20 cm (8")
FR-222-23	23 cm (9")
FR-222-25	25 cm (9 ¾")
FR-222-30	30 cm (11 ¾")



Modell. USA Slender Pattern Dressing Forcep
1 x 2 Teeth

Catalog #	Size
FR-224-13	13 cm (5")
FR-224-14	14.5 cm (5 ¾")
FR-224-16	16 cm (6 ¼")



Dissecting Forceps
 Anatomische Pinzetten
 Pinzas de disección
 Pinces à dissection
 Pinze per dissezione

Stille Dissecting Forcep
 1 x 2 Teeth



Catalog #	Size
FR-230-15	15 cm (6")



Stille Dissecting Forcep
 2 x 3 Teeth



Catalog #	Size
FR-232-15	15 cm (6")



Stone Dissecting Forcep
 4 x 5 Teeth



Catalog #	Size
FR-234-15	15 cm (6")



Lerche Dissecting Forcep
 5 x 6 Teeth



Catalog #	Size
FR-236-15	15 cm (6")



Adlercreutz Dissecting Forcep
 2 x 3 Teeth

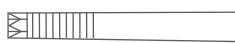

Catalog #	Size
FR-240-15	15.5 cm (6")
FR-240-20	20.5 cm (8")



Dissecting Forceps
Anatomische Pinzetten
Pinzas de disección
Pinces à dissection
Pinze per dissezione

Adlercreutz Dissecting Forcep

4 x 5 Teeth

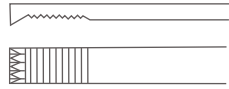

Catalog #	Size
FR-242-15	16 cm (6 1/4")
FR-242-20	20 cm (8")
FR-242-25	25 cm (9 3/4")



Adson Dissecting Forcep

1 x 2 Teeth

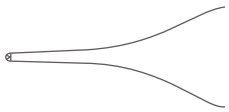

Catalog #	Size
FR-250-12	12 cm (4 3/4")
FR-250-15	15 cm (6")



Mini-Adson Dissecting Forcep

1 x 2 Teeth, Cross Serrated

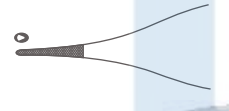

Catalog #	Size
FR-252-12	12 cm (4 3/4")



Mini-Adson Dissecting Forcep

Curved, 1 x 2 Teeth, Cross Serrated



Catalog #	Size
FR-253-12	12 cm (4 3/4")



Micro-Adson Dissecting Forcep

1 x 2 Teeth

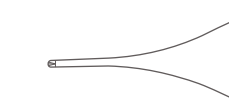

Catalog #	Size
FR-256-12	12 cm (4 3/4")
FR-256-15	15 cm (6")



Dissecting Forceps
 Anatomische Pinzetten
 Pinzas de disección
 Pinces à dissection
 Pinze per dissezione

Adson-Brown Dissecting Forcep

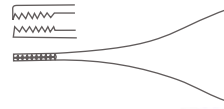

Catalog #	Size, Profile
FR-258-12	12 cm (4 3/4"), 7 x 7 Teeth
FR-260-12	12 cm (4 3/4"), 9 x 9 Teeth



Gillies Dissecting Forcep

1 x 2 Teeth, Cross Serrated



Catalog #	Size
FR-270-15	15.5 cm (6")



Waugh Dissecting Forcep

1 x 2 Teeth, Cross Serrated



Catalog #	Size
FR-272-20	20.5 cm (8")



Semken Dissecting Forcep

1 x 2 Teeth

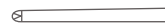

Catalog #	Size
FR-274-12	12.5 cm (5")
FR-274-15	15.5 cm (6")



Taylor Dissecting Forcep

1 x 2 Teeth



Catalog #	Size
FR-280-17	17.5 cm (7")



Dissecting Forceps
Anatomische Pinzetten
Pinzas de disección
Pinces à dissection
Pinze per dissezione

Taylor Dissecting Forcep
1 x 2 Teeth, With Dissector End

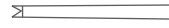

Catalog #	Size
FR-282-17	17 cm (6 3/4")



Taylor Dissecting Forcep
Bayonet Shaped, 1 x 2 Teeth

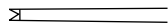

Catalog #	Size
FR-283-17	18.5 cm (7 1/4")



Dissecting Forcep
1 x 2 Teeth



Catalog #	Size
FR-286-06	15.5 cm (6"), 0.6 mm
FR-286-08	15.5 cm (6"), 0.8 mm
FR-286-10	15.5 cm (6"), 1.0 mm



Gerald Dissecting Forcep
Straight, 1 x 2 Teeth



Catalog #	Size
FR-290-17	17.5 cm (7")
FR-290-23	23 cm (9")



Gerald Dissecting Forcep
Curved, 1 x 2 Teeth



Catalog #	Size
FR-291-17	15.5 cm (6")



Dissecting Forceps
 Anatomische Pinzetten
 Pinzas de disección
 Pinces à dissection
 Pinze per dissezione

Cushing Dissecting Forcep
 1 x 2 Teeth

Catalog #	Size
FR-294-17	18 cm (7")
FR-294-20	20 cm (8")
FR-294-25	25 cm (9 3/4")



Potts-Smith Dissecting Forcep
 1 x 2 Teeth

Catalog #	Size
FR-296-18	18 cm (7")
FR-296-21	21 cm (8 1/4")
FR-296-25	24 cm (9 1/2")

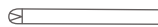

McIndoe Dissecting Forcep
 1 x 2 Teeth

Catalog #	Size
FR-298-15	15 cm (6")



Brophy Dissecting Forcep
 1 x 2 Teeth

Catalog #	Size
FR-300-20	20 cm (8")



Bonner-Modell Dissecting Forcep
 1 x 2 Teeth, With Plateau

Catalog #	Size
FR-302-09	9.5 cm (3 3/4")



Dissecting Forceps, Jeweller Type Forceps
 Anatomische Pinzetten, Uhrmacher-Pinzetten
 Pinzas de disección, Pinzas de relojero
 Pincès à dissection, Pincès d`horloger
 Pinze per dissezione, Pinze da orologiaio

Dissecting Forcep
 1 x 2 Teeth



Catalog #	Size
FR-304-10	10.5 cm (4")



Jeweller Forcep
 Fig. 1



Catalog #	Size
FR-310-01	12 cm (5")

Jeweller Forcep
 Fig. 2



Catalog #	Size
FR-310-02	12 cm (5")

Jeweller Forcep
 Fig. 3



Catalog #	Size
FR-310-03	12 cm (4 3/4")

Jeweller Forcep
 Fig. 4



Catalog #	Size
FR-310-04	11 cm (4 1/4")

Jeweller Type Forceps
 Uhrmacher-Pinzetten
 Pinzas de relojero
 Pinces d'horloger
 Pinze da orologiaio

Jeweller Forcep
 Fig. 5



Catalog #	Size
FR-310-05	11 cm (4 1/4")

Jeweller Forcep
 Fig. 3c



Catalog #	Size
FR-310-13	11 cm (4 1/4")

Jeweller Forcep
 Fig. 5a



Catalog #	Size
FR-310-15	11 cm (4 1/4")

Jeweller Forcep
 Fig. 5/45°



Catalog #	Size
FR-310-45	10.5 cm (4 1/4")

Jeweller Forcep
 Fig. 5/90°

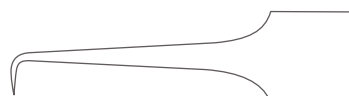

Catalog #	Size
FR-310-90	10.5 cm (4 1/4")

Jeweller Type Forceps
Uhrmacher-Pinzetten
Pinzas de relojero
Pinces d`horloger
Pinze da orologiaio

Jeweller Forcep
Fig. 7



Catalog #	Size
FR-310-07	12 cm (4 3/4")

Jeweller Forcep
1 x 2 Teeth



Catalog #	Size, Tip Size
FR-313-13	11.5 cm (4 1/2"), 0.4 mm

Jeweller Forcep

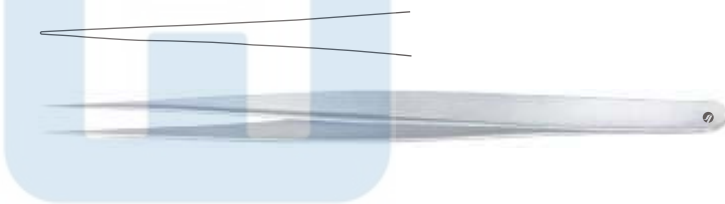

Catalog #	Size, Tip Size
FR-316-13	13.5 cm (5 1/4"), 0.3 mm

Jeweller Forcep
1 x 2 Teeth

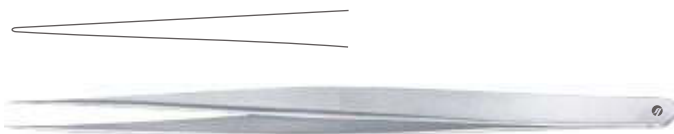

Catalog #	Size, Tip Size
FR-318-13	13.5 cm (5 1/4"), 0.4 mm

Jeweller Forcep
Straight, With Plateau



Catalog #	Size, Tip Size
FR-320-12	12 cm (3 3/4"), 0.3 mm

Jeweller Type Forceps, Micro Forceps
 Uhrmacher-Pinzetten, Mikropinzetten
 Pinzas de relojero, Micro Pinzas
 Pinces d` horloger, Micro-Pinces
 Pinze da orologiaio, Micro-Pinze

Vise Micro Jeweller Forcep
 Straight, With Plateau



Catalog #	Size, Tip Size
FR-322-13	13.5 cm (5 1/4"), 0.3 mm

Vise Micro Jeweller Forcep
 Curved, With Plateau



Catalog #	Size, Tip Size
FR-323-13	13.5 cm (5 1/4"), 0.3 mm

Micro Vessel Dilator



Catalog #	Size, Diameter
FR-325-00	11 cm (4 1/4"), Ø 0.20 mm

Micro Vessel Dilator



Catalog #	Size, Diameter
FR-325-01	11 cm (4 1/4"), Ø 0.30 mm

Micro Pierce Forcep



Catalog #	Size, Diameter
FR-325-02	11 cm (4 1/4"), Ø 0.30 mm

Micro Dilating Forceps, Tissue Forceps
 Gefäß-Dilatationspinzetten, Chirurgische Pinzetten
 Micro pinza de dilatación, Pinzas de disección con diente
 Micro pince à dilater, Pinces à dissection à griffes
 Micro pinze per dilatazione, Pinze per dissezione con denti

Micro Vessel Dilator

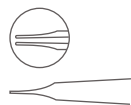

Catalog #	Size, Diameter
FR-327-00	13 cm (5"), Ø 0.20 mm

Micro Vessel Dilator

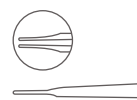

Catalog #	Size, Diameter
FR-327-01	13 cm (5"), Ø 0.30 mm

Micro Pierce Forcep

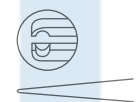

Catalog #	Size, Diameter
FR-327-02	13 cm (5"), Ø 0.30 mm

Selman Dissecting Forcep

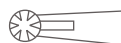

Catalog #	Size
FR-328-15	15.5 cm (6")

Russian Modell Dissecting Forcep



Catalog #	Size
FR-330-15	15 cm (5")
FR-330-20	20 cm (8")
Fr-330-25	25.5 cm (10")

Tissue Forceps
 Chirurgische Pinzetten
 Pinzas de disección con diente
 Pincas à dissection à griffes
 Pinze per dissezione con denti

Durante Dissecting Forcep



Catalog #	Size
FR-332-14	14.5 cm (5 3/4")
FR-332-16	16 cm (6 1/4")
Fr-332-20	20.5 cm (8")

Stille-Barraya Dissecting Forcep



Catalog #	Size
FR-334-18	18 cm (7")
FR-334-20	20 cm (8")
Fr-334-25	25 cm (9 3/4")

Ferris-Smith Dissecting Forcep
 2 x 3 Teeth



Catalog #	Size
FR-336-18	18 cm (7")



Bonney Dissecting Forcep
 1 x 2 Teeth



Catalog #	Size
FR-338-18	17.5 cm (7")



Mayo (Russian) Dissecting Forcep



Catalog #	Size
FR-340-23	23 cm (9")

Tissue Forceps
 Chirurgische Pinzetten
 Pinzas de disección con diente
 Pinces à dissection à griffes
 Pinze per dissezione con denti

Singley-Tuttle Dissecting Forcep



Catalog #	Size
FR-344-18	18 cm (7")
FR-344-23	23 cm (9")

Collin-Duval Intestinal Forcep

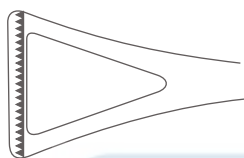

Catalog #	Size, Width
FR-348-14	20 cm (8"), 14.0 mm
FR-348-18	20 cm (8"), 18.0 mm
FR-348-23	20 cm (8"), 23.0 mm

Duval Intestinal Forcep



Catalog #	Size
FR-350-14	14 cm (5 1/2")

Dennis-Browne Intestinal Forcep



Catalog #	Size
FR-352-19	19 cm (7 1/2")

Nelson Dissecting Forcep

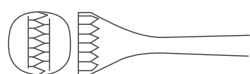

Catalog #	Size
FR-354-23	23 cm (9")

Tissue Forceps
 Chirurgische Pinzetten
 Pinzas de disección con diente
 Pinces à dissection à griffes
 Pinze per dissezione con denti

Lane Dissecting Forcep
 1 x 2 Teeth

Catalog #	Size
FR-360-12	12.5 cm (5")
FR-360-14	14.5 cm (5 ¾")
FR-360-17	17.5 cm (7")



Lane Dissecting Forcep
 2 x 3 Teeth

Catalog #	Size
FR-362-14	14.5 cm (5 ¾")
FR-362-17	17.5 cm (7")

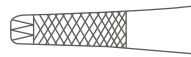

Treves Dissecting Forcep
 1 x 2 Teeth

Catalog #	Size
FR-366-12	12.5 cm (5")
FR-366-15	15 cm (6")



Ramsey Dissecting Forcep
 1 x 2 Teeth

Catalog #	Size
FR-368-18	18 cm (7")



Ramsey Dissecting Forcep
 3 x 4 Teeth

Catalog #	Size
FR-370-18	18 cm (7")

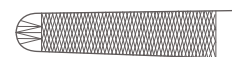

Tissue Forceps, Grasping Forceps
 Chirurgische Pinzetten, Fassungszetten
 Pinzas de disección con diente, Pinzas para coger
 Pincès à dissection à griffes, Pincès pour saisir les tissus
 Pinze per dissezione con denti, Pinze per afferrare tessuti

Strassburger Modell Dissecting Forcep

1 x 2 Teeth



Catalog #	Size
FR-374-15	15 cm (6")
FR-374-20	20 cm (8")



Jackson-Burrows Dissecting Forcep

1 x 2 Teeth, With Platform



Catalog #	Size
FR-376-14	14 cm (5 1/2")



Charnley Dissecting Forcep

1 x 2 Teeth, With Platform



Catalog #	Size
FR-378-18	18 cm (7")



Samii Tumor Grasping Forcep

Right, Bayonet Shaped



Catalog #	Size, Tip Diameter
FR-401-01	24 cm (9 1/2"), Ø 3.0 mm

Samii Tumor Grasping Forcep

Left, Bayonet Shaped



Catalog #	Size, Tip Diameter
FR-401-02	24 cm (9 1/2"), Ø 3.0 mm

Grasping Forceps
 Fasspinzetten
 Pinzas para coger
 Pinces pour saisir les tissus
 Pinze per afferrare tessuti

Yasargil Tumor Grasping Forcep
 Bayonet Shaped

Catalog #	Size, Tip Diameter
FR-403-01	22 cm (8 3/4"), Ø 3.0 mm
FR-403-02	22 cm (8 3/4"), Ø 5.0 mm



Yasargil Tumor Grasping Forcep
 Bayonet Shaped

Catalog #	Size, Tip Diameter
FR-403-03	22 cm (8 3/4"), Ø 3.0 mm
FR-403-04	22 cm (8 3/4"), Ø 5.0 mm



Heifetz Tumor Grasping Forcep
 Bayonet Shaped

Catalog #	Size, Tip Diameter
FR-405-01	22 cm (8 3/4"), Ø 3.0 mm
FR-405-02	22 cm (8 3/4"), Ø 5.0 mm



Hunt Tumor Grasping Forcep
 Angled

Catalog #	Size, Tip Diameter
FR-407-20	20 cm (8"), Ø 5.0 mm



Grasping Forceps
 Fasspinzetten
 Pinzas para coger
 Pinces pour saisir les tissus
 Pinze per afferrare tessuti

Yasargil Micro Forcep
 Bayonet Shaped

Catalog #	Size, Tip Size
FR-411-16	16 cm (6 ¼"), 0.6 mm
FR-411-18	18 cm (7"), 0.6 mm
FR-411-20	20 cm (8"), 0.6 mm
FR-411-22	22 cm (8 ¾"), 0.6 mm
FR-411-24	24 cm (9 ½"), 0.6 mm



Yasargil Micro Forcep
 Bayonet Shaped

Catalog #	Size, Tip Size
FR-413-16	16 cm (6 ¼"), 0.9 mm
FR-413-18	18 cm (7"), 0.9 mm
FR-413-20	20 cm (8"), 0.9 mm
FR-413-22	22 cm (8 ¾"), 0.9 mm
FR-413-24	24 cm (9 ½"), 0.9 mm



Yasargil Micro Forcep
 Bayonet Shaped, 1 x 2 Teeth

Catalog #	Size
FR-415-16	16 cm (6 ¼")
FR-415-18	18 cm (7")
FR-415-20	20 cm (8")



Lazar Micro Suturing Forcep

Catalog #	Size, Tip Size
FR-420-05	15.5 cm (6"), 0.5 mm
FR-420-08	15.5 cm (6"), 0.8 mm



Micro Forceps
Mikropinzetten
Micro Pinzas
Micro-Pinces
Micro-Pinze

**Micro Suturing Forcep
With Platform**



Catalog #	Size, Tip Size
FR-422-18	18.5 cm (7 1/4"), 0.5 mm

**Austin Micro Suturing Forcep
With Platform**

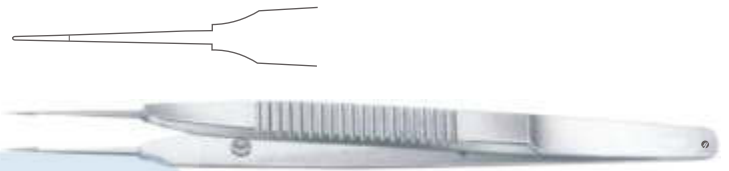

Catalog #	Size, Tip Size
FR-424-14	14 cm (5 1/2"), 0.8 mm

**Micro Suturing Forcep
With Platform**

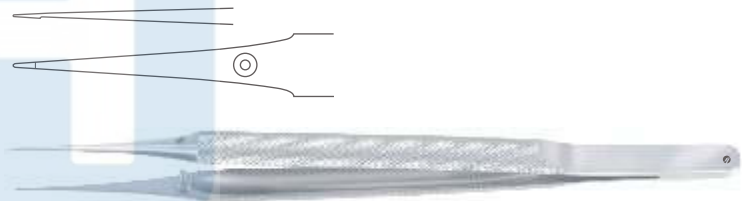

Catalog #	Size, Tip Size
FR-430-12	12 cm (4 3/4"), 0.3 mm
FR-430-15	15 cm (6"), 0.3 mm

**Micro Suturing Forcep
Curved, With Platform**



Catalog #	Size, Tip Size
FR-431-12	12 cm (4 3/4"), 0.3 mm
FR-431-15	15 cm (6"), 0.3 mm

**Micro Suturing Forcep
With Platform**

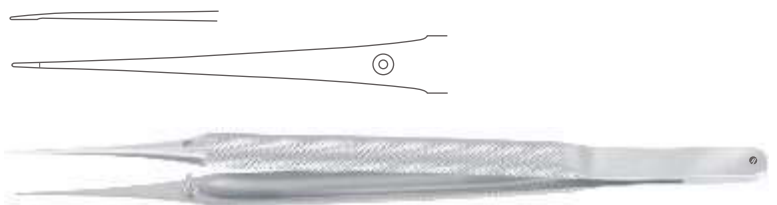

Catalog #	Size, Tip Size
FR-432-18	18 cm (7"), 0.5 mm

Micro Forceps
Mikropinzetten
Micro Pinzas
Micro-Pinces
Micro-Pinze

Micro Suturing Forcep
Curved, With Platform

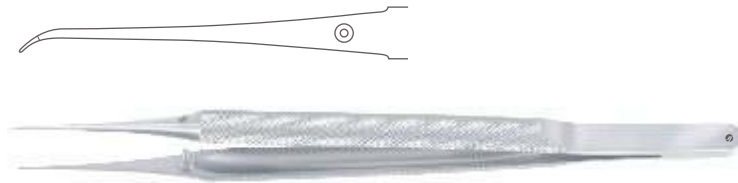

Catalog #	Size, Tip Size
FR-433-18	18 cm (7"), 0.5 mm

Diam-n-Dust™ Micro Dressing Forcep
Straight



Catalog #	Size, Tip Size
FR-500-15	15 cm (6"), 6.0 x 0.4 mm
FR-500-18	18 cm (7"), 6.0 x 0.4 mm

Diam-n-Dust™ Micro Dressing Forcep
Straight, Titanium

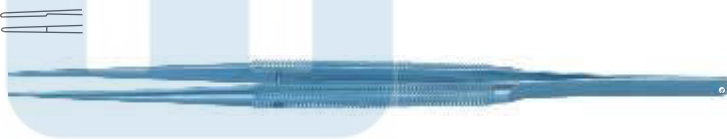

Catalog #	Size, Tip Size
FR-500-15 T	15 cm (6"), 6.0 x 0.4 mm
FR-500-18 T	18 cm (7"), 6.0 x 0.4 mm

Diam-n-Dust™ Micro Dressing Forcep
Curved



Catalog #	Size, Tip Size
FR-501-15	15 cm (6"), 6.0 x 0.4 mm
FR-501-18	18 cm (7"), 6.0 x 0.4 mm

Diam-n-Dust™ Micro Dressing Forcep
Curved, Titanium



Catalog #	Size, Tip Size
FR-501-15 T	15 cm (6"), 6.0 x 0.4 mm
FR-501-18 T	18 cm (7"), 6.0 x 0.4 mm

Micro Forceps
Mikropinzetten
Micro Pinzas
Micro-Pinces
Micro-Pinze

Diam-n-Dust™ Micro Dressing Forcep
Straight



Catalog #	Size, Tip Size
FR-504-15	15 cm (6"), 6.0 x 0.7 mm
FR-504-18	18 cm (7"), 6.0 x 0.7 mm
FR-504-21	21 cm (8 1/4"), 6.0 x 0.7 mm
FR-504-23	23 cm (9"), 6.0 x 0.7 mm



Diam-n-Dust™ Micro Dressing Forcep
Straight, Titanium



Catalog #	Size, Tip Size
FR-504-15 T	15 cm (6"), 6.0 x 0.7 mm
FR-504-18 T	18 cm (7"), 6.0 x 0.7 mm
FR-504-21 T	21 cm (8 1/4"), 6.0 x 0.7 mm



Diam-n-Dust™ Micro Dressing Forcep
Curved



Catalog #	Size, Tip Size
FR-505-15	15 cm (6"), 6.0 x 0.7 mm
FR-505-18	18 cm (7"), 6.0 x 0.7 mm
FR-505-21	21 cm (8 1/4"), 6.0 x 0.7 mm
FR-505-23	23 cm (9"), 6.0 x 0.7 mm



Diam-n-Dust™ Micro Dressing Forcep
Curved, Titanium



Catalog #	Size, Tip Size
FR-505-15 T	15 cm (6"), 6.0 x 0.7 mm
FR-505-18 T	18 cm (7"), 6.0 x 0.7 mm
FR-505-21 T	21 cm (8 1/4"), 6.0 x 0.7 mm



Diam-n-Dust™ Micro Dissecting Forcep
Straight, 1 x 2 Teeth



DIAM-N-DUST™

Catalog #	Size, Tip Size
FR-508-15	15 cm (6"), 6.0 x 0.4 mm
FR-508-18	18 cm (7"), 6.0 x 0.4 mm



Diam-n-Dust™ Micro Dissecting Forcep
Straight, 1 x 2 Teeth, Titanium



DIAM-N-DUST™

Catalog #	Size, Tip Size
FR-508-15 T	15 cm (6"), 6.0 x 0.4 mm
FR-508-18 T	18 cm (7"), 6.0 x 0.4 mm



Diam-n-Dust™ Micro Dissecting Forcep
Curved, 1 x 2 Teeth



DIAM-N-DUST™

Catalog #	Size, Tip Size
FR-509-15	15 cm (6"), 6.0 x 0.4 mm
FR-509-18	18 cm (7"), 6.0 x 0.4 mm



Diam-n-Dust™ Micro Dissecting Forcep
Curved, 1 x 2 Teeth, Titanium



DIAM-N-DUST™

Catalog #	Size, Tip Size
FR-509-15 T	15 cm (6"), 6.0 x 0.4 mm
FR-509-18 T	18 cm (7"), 6.0 x 0.4 mm



Micro Forceps
Mikropinzetten
Micro Pinzas
Micro-Pinces
Micro-Pinze

Diam-n-Dust™ Micro Dissecting Forcep
Straight, 1 x 2 Teeth



Catalog #	Size, Tip Size
FR-512-15	15 cm (6"), 6.0 x 0.7 mm
FR-512-18	18 cm (7"), 6.0 x 0.7 mm
FR-512-21	21 cm (8 1/4"), 6.0 x 0.7 mm
FR-512-23	23 cm (9"), 6.0 x 0.7 mm



Diam-n-Dust™ Micro Dissecting Forcep
Straight, 1 x 2 Teeth, Titanium



Catalog #	Size, Tip Size
FR-512-15 T	15 cm (6"), 6.0 x 0.7 mm
FR-512-18 T	18 cm (7"), 6.0 x 0.7 mm
FR-512-21 T	21 cm (8 1/4"), 6.0 x 0.7 mm



Diam-n-Dust™ Micro Dissecting Forcep
Curved, 1 x 2 Teeth



Catalog #	Size, Tip Size
FR-513-15	15 cm (6"), 6.0 x 0.7 mm
FR-513-18	18 cm (7"), 6.0 x 0.7 mm
FR-513-21	21 cm (8 1/4"), 6.0 x 0.7 mm
FR-513-23	23 cm (9"), 6.0 x 0.7 mm



Diam-n-Dust™ Micro Dissecting Forcep
Curved, 1 x 2 Teeth, Titanium



Catalog #	Size, Tip Size
FR-513-15 T	15 cm (6"), 6.0 x 0.7 mm
FR-513-18 T	18 cm (7"), 6.0 x 0.7 mm
FR-513-21 T	21 cm (8 1/4"), 6.0 x 0.7 mm



Diam-n-Dust™ Micro Ring Forcep



Catalog #	Size, Tip Diameter
FR-516-15	15 cm (6"), Ø 1.0 x 0.5 mm
FR-516-18	18 cm (7"), Ø 1.0 x 0.5 mm
FR-516-21	21 cm (8 ¼"), Ø 1.0 x 0.5 mm
FR-516-23	23 cm (9"), Ø 1.0 x 0.5 mm



Diam-n-Dust™ Micro Ring Forcep Titanium



Catalog #	Size, Tip Diameter
FR-516-15 T	15 cm (6"), Ø 1.0 x 0.5 mm
FR-516-18 T	18 cm (7"), Ø 1.0 x 0.5 mm
FR-516-21 T	21 cm (8 ¼"), Ø 1.0 x 0.5 mm

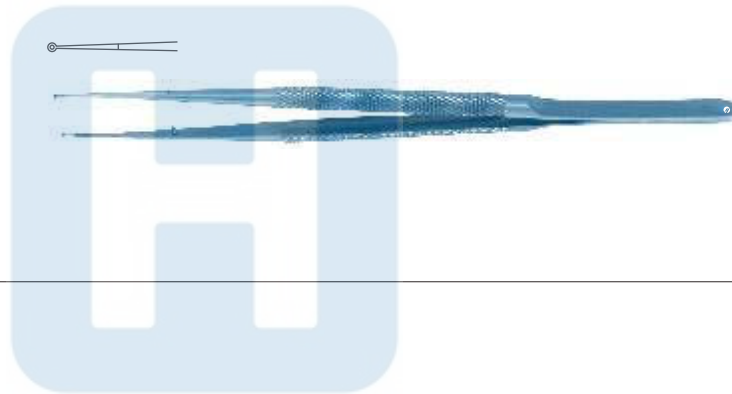

Diam-n-Dust™ Micro Ring Forcep



Catalog #	Size, Tip Diameter
FR-518-15	15 cm (6"), Ø 2.0 x 1.0 mm
FR-518-18	18 cm (7"), Ø 2.0 x 1.0 mm
FR-518-21	21 cm (8 ¼"), Ø 2.0 x 1.0 mm
FR-518-23	23 cm (9"), Ø 2.0 x 1.0 mm



Diam-n-Dust™ Micro Ring Forcep Titanium



Catalog #	Size, Tip Diameter
FR-518-15 T	15 cm (6"), Ø 2.0 x 1.0 mm
FR-518-18 T	18 cm (7"), Ø 2.0 x 1.0 mm
FR-518-21 T	21 cm (8 ¼"), Ø 2.0 x 1.0 mm



Micro Forceps
Mikropinzetten
Micro Pinzas
Micro-Pinces
Micro-Pinze

Micro Atrauma Forcep



Catalog #	Size, Tip Size
FR-520-15	15 cm (6"), 1.2 mm
FR-520-18	18 cm (7"), 1.2 mm
FR-520-21	21 cm (8 1/4"), 1.2 mm

**Micro Atrauma Forcep
Titanium**



Catalog #	Size, Tip Size
FR-520-15 T	15 cm (6"), 1.2 mm
FR-520-18 T	18 cm (7"), 1.2 mm
FR-520-21 T	21 cm (8 1/4"), 1.2 mm

**Diam-n-Dust™ Micro Suturing Forcep
Straight**



Catalog #	Size, Diameter
FR-522-00	15 cm (6"), Ø 0.4 mm

**Diam-n-Dust™ Micro Suturing Forcep
Curved**



Catalog #	Size, Diameter
FR-522-01	15 cm (6"), Ø 0.4 mm

**Diam-n-Dust™ Micro Suturing Forcep
Angled**



Catalog #	Size, Diameter
FR-522-02	15 cm (6"), Ø 0.4 mm

Micro Forceps
Mikropinzetten
Micro Pinzas
Micro-Pinces
Micro-Pinze

Diam-n-Dust™ Micro Ring Forcep



Catalog #	Size, Tip Diameter
FR-522-03	15 cm (6"), Ø 1.0 x 0.5 mm



Micro Vessel Dilator

Catalog #	Size, Tip Diameter
FR-522-04	15 cm (6"), Ø 0.3 mm



Micro Pierce Forcep

Catalog #	Size, Tip Diameter
FR-522-05	15 cm (6"), Ø 0.4 mm



Diam-n-Dust™ Micro Suturing Forcep Straight



Catalog #	Size, Tip Diameter
FR-524-00	18 cm (7"), Ø 0.4 mm



Diam-n-Dust™ Micro Suturing Forcep Curved



Catalog #	Size, Tip Diameter
FR-524-01	18 cm (7"), Ø 0.4 mm



Micro Forceps
Mikropinzetten
Micro Pinzas
Micro-Pinces
Micro-Pinze

Diam-n-Dust™ Micro Suturing Forcep
Angled



Catalog #	Size, Tip Diameter
FR-524-02	18 cm (7"), Ø 0.4 mm



Diam-n-Dust™ Micro Ring Forcep



Catalog #	Size, Tip Diameter
FR-524-03	18 cm (7"), Ø 1.0 x 0.5 mm



Micro Vessel Dilator



Catalog #	Size, Tip Diameter
FR-524-04	18 cm (7"), Ø 0.3 mm



Micro Pierce Forcep

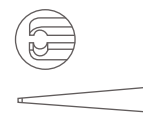

Catalog #	Size, Tip Diameter
FR-524-05	18 cm (7"), Ø 0.4 mm



Micro Vessel Dilator
With Counter Balance



Catalog #	Size, Tip Diameter
FR-526-00	15 cm (6"), Ø 0.3 mm



Micro Forceps
Mikropinzetten
Micro Pinzas
Micro-Pinces
Micro-Pinze

Micro Pierce Forcep
With Counter Balance



Catalog #	Size, Tip Diameter
FR-526-01	15 cm (6"), Ø 0.3 mm

Micro Vessel Dilator
With Counter Balance

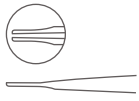

Catalog #	Size, Tip Diameter
FR-528-00	18 cm (7"), Ø 0.3 mm

Micro Vessel Dilator
With Counter Balance



Catalog #	Size, Tip Diameter
FR-528-01	18 cm (7"), Ø 0.3 mm

Diam-n-Dust™ Micro Ring Forcep
Straight, With Counter Balance



DIAM-N-DUST™

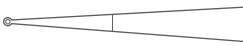

Catalog #	Size, Tip Diameter
FR-530-15	15 cm (6"), Ø 1.0 mm
FR-530-18	18.5 cm (7 1/4"), Ø 1.0 mm
FR-530-21	21 cm (8 1/4"), Ø 1.0 mm
FR-530-23	23 cm (9"), Ø 1.0 mm
FR-530-25	25 cm (9 3/4"), Ø 1.0 mm

Micro Forceps
Mikropinzetten
Micro Pinzas
Micro-Pinces
Micro-Pinze

Diam-n-Dust™ Micro Ring Forcep
Curved, With Counter Balance



Catalog #	Size, Tip Diameter
FR-531-15	15 cm (6"), Ø 1.0 mm
FR-531-18	18.5 cm (7 ¼"), Ø 1.0 mm
FR-531-21	21 cm (8 ¼"), Ø 1.0 mm
FR-531-23	23 cm (9"), Ø 1.0 mm
FR-531-25	25 cm (9 ¾"), Ø 1.0 mm



Diam-n-Dust™ Micro Ring Forcep
Straight, With Counter Balance



Catalog #	Size, Tip Diameter
FR-534-18	18.5 cm (7 ¼"), Ø 2.0 mm



Diam-n-Dust™ Micro Suturing Forcep
Straight, With Counter Balance



Catalog #	Size
FR-536-15	15 cm (6")
FR-536-18	18.5 cm (7 ¼")
FR-536-21	21 cm (8 ¼")
FR-536-25	25 cm (9 ¾")



Diam-n-Dust™ Micro Suturing Forcep
Curved, With Counter Balance



Catalog #	Size
FR-537-15	15 cm (6")
FR-537-18	18.5 cm (7 ¼")
FR-537-21	21 cm (8 ¼")
FR-537-25	25 cm (9 ¾")



Micro Forceps
Mikropinzetten
Micro Pinzas
Micro-Pinces
Micro-Pinze

Micro Atrauma Forcep
With Counter Balance

Catalog #	Size, Tip Size
FR-540-18	18.5 cm (7 ¼"), 1.2 mm
FR-540-21	21 cm (8 ¼"), 1.2 mm



Diam-n-Dust™ Micro Ring Forcep
Straight, With Long Platform



Catalog #	Size, Tip Diameter
FR-550-18	18.5 cm (7 ¼"), Ø 1.0 mm
FR-550-21	21 cm (8 ¼"), Ø 1.0 mm



Diam-n-Dust™ Micro Ring Forcep
Curved, With Long Platform



Catalog #	Size, Tip Diameter
FR-551-18	18.5 cm (7 ¼"), Ø 1.0 mm
FR-551-21	21 cm (8 ¼"), Ø 1.0 mm



Diam-n-Dust™ Micro Ring Forcep
Straight, With Short Platform



Catalog #	Size, Tip Diameter
FR-552-18	18.5 cm (7 ¼"), Ø 1.0 mm
FR-552-21	21 cm (8 ¼"), Ø 1.0 mm



Diam-n-Dust™ Micro Suturing Forcep
Straight



Catalog #	Size
FR-554-18	18.5 cm (7 ¼")
FR-554-21	21 cm (8 ¼")



Micro Forceps
Mikropinzetten
Micro Pinzas
Micro-Pinces
Micro-Pinze

Micro Atrauma Forcep
Straight



Catalog #	Size, Tip Size
FR-556-18	18.5 cm (7 1/4"), 1.2 mm
FR-556-21	21 cm (8 1/4"), 1.2 mm

Gerald Micro Forcep
Cross Serrated Jaws



Catalog #	Size, Tip Size
FR-558-18	18 cm (7"), 1.0 mm
FR-558-25	25 cm (9 3/4"), 1.0 mm

Gerald (DeBakey) Micro Atrauma Forcep



Catalog #	Size, Tip Size
FR-560-18	18 cm (7"), 1.0 mm
FR-560-21	20 cm (8"), 1.0 mm

Diam-n-Dust™ Gerald Micro Ring Forcep
Straight



Catalog #	Size, Tip Diameter
FR-562-18	18 cm (7"), Ø 1.0 mm

Diam-n-Dust™ Gerald Micro Ring Forcep
Curved



Catalog #	Size, Tip Diameter
FR-563-18	18 cm (7"), Ø 1.0 mm

Micro Forceps, Vascular Forceps
 Mikropinzetten, Gefäßpinzetten
 Micro Pinzas, Pinzas de disección vascular
 Micro-Pinces, Pinces à dissection vasculaires
 Micro-Pinze, Pinze per dissezione vascolari

Diam-n-Dust™ Gerald Micro Suturing Forcep



Catalog #	Size, Tip Size
FR-566-18	18 cm (7"), 1.0 mm
FR-566-20	20 cm (8"), 1.0 mm

Micro Dressing Forcep Cross Serrated Jaws



Catalog #	Size
FR-568-20	20 cm (8")

DeBakey Atrauma Forcep Ultra Light Pattern



Catalog #	Size, Tip Size
FR-580-15	15 cm (6"), 1.2 mm

DeBakey Atrauma Forcep Ultra Light Pattern

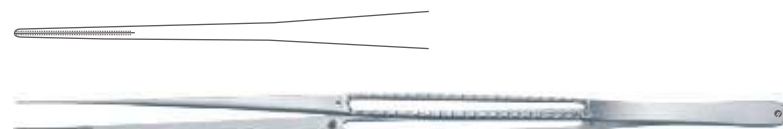

Catalog #	Size, Tip Size
FR-582-20	20 cm (8"), 1.5 mm
FR-582-24	24 cm (9 1/2"), 1.5 mm
FR-582-30	30 cm (11 3/4"), 1.5 mm

DeBakey Atrauma Forcep



Catalog #	Size, Tip Size
FR-584-15	15 cm (6"), 1.0 mm
FR-584-20	20 cm (8"), 1.0 mm
FR-584-24	24 cm (9 1/2"), 1.0 mm

Vascular Forceps
 Gefäßpinzetten
 Pinzas de disección vascular
 Pinces à dissection vasculaires
 Pinze per dissezione vascolari

DeBakey Atrauma Forcep

Catalog #	Size, Tip Size
FR-590-16	16 cm (6 1/4"), 1.5 mm
FR-590-20	20 cm (8"), 1.5 mm
FR-590-24	24.5 cm (9 3/4"), 1.5 mm
FR-590-30	30 cm (11 3/4"), 1.5 mm



DeBakey Atrauma Forcep
 Titanium

Catalog #	Size, Tip Size
FR-590-16 T	16 cm (6 1/4"), 1.5 mm
FR-590-20 T	20 cm (8"), 1.5 mm
FR-590-24 T	24.5 cm (9 3/4"), 1.5 mm



DeBakey Atrauma Forcep

Catalog #	Size, Tip Size
FR-592-16	16 cm (6 1/4"), 2.0 mm
FR-592-20	20 cm (8"), 2.0 mm
FR-592-24	24.5 cm (9 3/4"), 2.0 mm
FR-592-30	30 cm (11 3/4"), 2.0 mm



DeBakey Atrauma Forcep
 Titanium

Catalog #	Size, Tip Size
FR-592-16 T	16 cm (6 1/4"), 2.0 mm
FR-592-20 T	20 cm (8"), 2.0 mm
FR-592-24 T	24.5 cm (9 3/4"), 2.0 mm



Vascular Forceps
 Gefäßpinzetten
 Pinzas de disección vascular
 Pinces à dissection vasculaires
 Pinze per dissezione vascolari

DeBakey Atrauma Forcep
 Angled



Catalog #	Size, Tip Size
FR-593-16	16 cm (6 ¼"), 2.0 mm
FR-593-20	19.5 cm (7 ¾"), 2.0 mm
FR-593-24	24.5 cm (9 ¾"), 2.0 mm
FR-593-30	29.5 cm (11 ½"), 2.0 mm

DeBakey Atrauma Forcep

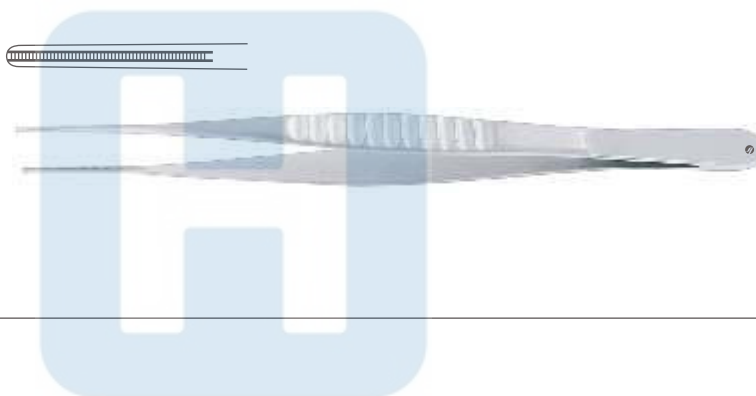

Catalog #	Size, Tip Size
FR-594-16	16 cm (6 ¼"), 2.8 mm
FR-594-20	20 cm (8"), 2.8 mm
FR-594-24	24.5 cm (9 ¾"), 2.8 mm
FR-594-30	30 cm (11 ¾"), 2.8 mm

DeBakey Atrauma Forcep



Catalog #	Size, Tip Size
FR-596-16	16 cm (6 ¼"), 3.5 mm
FR-596-20	20 cm (8"), 3.5 mm
FR-596-24	24.5 cm (9 ¾"), 3.5 mm
FR-596-30	30 cm (11 ¾"), 3.5 mm

Cooley Atrauma Forcep



Catalog #	Size, Tip Size
FR-598-16	16 cm (6 ¼"), 2.0 mm
FR-598-20	20 cm (8"), 2.0 mm
FR-598-24	24 cm (9 ½"), 2.0 mm

Splinter Forceps
 Splitterpinzetten
 Pinzas para espinas
 Pinces à échardes
 Pinze per scheggie

Splinter Forcep
 Straight, Smooth Jaws

Catalog #	Size
FR-600-10	10 cm (4")
FR-600-12	12.5 cm (5")



Splinter Forcep
 Curved, Smooth Jaws

Catalog #	Size
FR-601-12	12.5 cm (5")



Splinter Forcep
 Angled, Smooth Jaws

Catalog #	Size
FR-603-10	10 cm (4")



Splinter Forcep
 Straight, Serrated Jaws

Catalog #	Size
FR-606-09	9 cm (3 1/2")
FR-606-10	10.5 cm (4")
FR-606-11	11.5 cm (4 1/2")
FR-606-13	13 cm (5")
FR-606-14	14.5 cm (5 3/4")



Splinter Forceps
 Splitterpinzetten
 Pinzas para espinas
 Pincas à échardes
 Pinze per scheggie

Splinter Forcep
 Curved, Serrated Jaws

Catalog #	Size
FR-607-09	9 cm (3 ½")
FR-607-10	10.5 cm (4")
FR-607-11	11.5 cm (4 ½")
FR-607-13	12.5 cm (5")
FR-607-14	14.5 cm (5 ¾")



Feilchenfeld Splinter Forcep

Catalog #	Size
FR-610-07	7.5 cm (3 ¼")
FR-610-09	9 cm (3 ½")
FR-610-11	11.5 cm (4 ½")

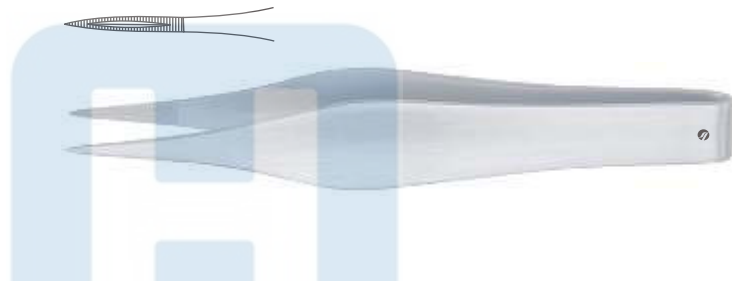

Hunter Splinter Forcep
 Straight

Catalog #	Size
FR-612-10	10.5 cm (4")



Hunter Splinter Forcep
 Curved

Catalog #	Size
FR-613-10	10.5 cm (4")



Shaaf Splinter Forcep

Catalog #	Size
FR-620-09	9.5 cm (3 ¾")



Splinter Forceps
 Splitterpinzetten
 Pinzas para espinas
 Pinces à échardes
 Pinze per scheggie

Littauer Cilia Forcep
 Smooth Jaws



Catalog #	Size
FR-622-08	8.5 cm (3 1/4")

Bergh Cilia Forcep
 Serrated Jaws



Catalog #	Size
FR-624-09	8.5 cm (3 1/4")

Douglas Cilia Forcep
 Narrow Tip



Catalog #	Size
FR-626-09	9 cm (3 1/2")

Douglas Cilia Forcep
 Wide Tip



Catalog #	Size
FR-628-09	9 cm (3 1/2")

Beer Cilia Forcep
 Smooth Jaws



Catalog #	Size
FR-630-09	9 cm (3 1/2")

Splinter Forceps
 Splitterpinzetten
 Pinzas para espinas
 Pinces à échardes
 Pinze per scheggie

Barraquer Cilia Forcep
 Smooth Jaws



Catalog #	Size
FR-632-10	10.5 cm (4")

Stieglitz Splinter Forcep
 Straight

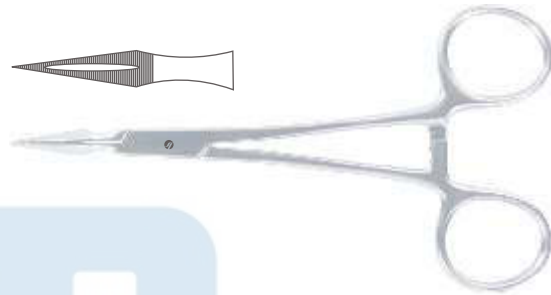

Catalog #	Size
FR-650-14	14 cm (5 1/2")

Stieglitz Splinter Forcep
 Curved

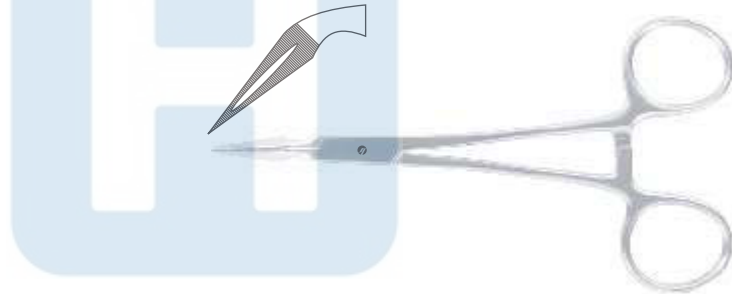

Catalog #	Size
FR-651-14	13.5 cm (5 1/4")

Peet Splinter Forcep



Catalog #	Size
FR-655-11	12.5 cm (5")

Ralk Splinter Forcep
 Straight



Catalog #	Size
FR-660-15	15 cm (6")

Eye Surgery Forceps
 Augenchirurgie Pinzetten
 Ojo Pinzas Cirugia
 Pince de chirurgie oculaire
 Eye Pinze Chirurgia

Ralk Splinter Forcep
 Curved



Catalog #	Size
FR-661-15	15 cm (6")

Graefe Eye Dressing Forcep
 Straight



Catalog #	Size
FR-700-01	10 cm (4")

Graefe Eye Dressing Forcep
 Gently Curved



Catalog #	Size
FR-700-02	10 cm (4")

Graefe Eye Dressing Forcep
 Strongly Curved



Catalog #	Size
FR-700-03	9.5 cm (3 3/4")

Graefe Dissecting Forcep
 Straight, 1 x 2 Teeth



Catalog #	Size
FR-702-01	10 cm (4")



Eye Surgery Forceps
 Augen Chirurgie Pinzetten
 Ojo Pinzas Cirugia
 Pince de chirurgie oculaire
 Eye Pinze Chirurgia

Graefe Dissecting Forcep
 Gently Curved, 1 x 2 Teeth

Catalog #	Size
FR-702-02	10 cm (4")



Graefe Dissecting Forcep
 Strongly Curved, 1 x 2 Teeth

Catalog #	Size
FR-702-03	9.5 cm (3 3/4")



Botvin Iris Forcep
 Serrated

Catalog #	Size
FR-710-07	7.5 cm (3 1/4")



Botvin Iris Forcep
 1 x 2 Teeth

Catalog #	Size
FR-712-07	7.5 cm (3 1/4")



Gills-Colibri Corneal Forcep
 Very Fine Pointed Tips With Tying Platform

Catalog #	Size
FR-714-07	7.5 cm (3 1/4")



Eye Surgery Forceps
 Augen Chirurgie Pinzetten
 Ojo Pinzas Cirugia
 Pince de chirurgie oculaire
 Eye Pinze Chirurgia

Colibri Corneal Forcep
 Very Delicate 1 x 2 Teeth

Catalog #	Size, Tip Size
FR-716-07	7.5 cm (3 1/4"), 0.12 mm



Harms-Colibri Corneal Forcep
 Very Delicate 1 x 2 Teeth With Tying Platform

Catalog #	Size, Tip Size
FR-718-07	7.5 cm (3 1/4"), 0.12 mm



Harms-Colibri Corneal Forcep
 Very Delicate 1 x 2 Teeth With Tying Platform, Titanium

Catalog #	Size, Tip Size
FR-718-07 T	7.5 cm (3 1/4"), 0.12 mm



Colibri Corneal Forcep
 Standard 1 x 2 Teeth With Tying Platform

Catalog #	Size, Tip Size
FR-720-07	7.5 cm (3 1/4"), 0.4 mm



Pierce-Colibri Corneal Forcep
 1 x 1 Teeth

Catalog #	Size, Tip Size
FR-721-07	7.5 cm (3 1/4"), 0.1 mm



Eye Surgery Forceps
 Augen Chirurgie Pinzetten
 Ojo Pinzas Cirugia
 Pince de chirurgie oculaire
 Eye Pinze Chirurgia

Hoskins Tissue Forcep
 Straight, 1 x 1 Teeth



Catalog #	Size
FR-722-08	8 cm (3 1/4")



Hoskins Tissue Forcep
 Curved, 1 x 1 Teeth



Catalog #	Size
FR-723-08	8 cm (3 1/4")



Fechtner Conjunctival Forcep
 Very Delicate Ring Shaped Tips With Tying Platform



Catalog #	Size
FR-724-10	10.5 cm (4")

Gastroviejo-Colibri Corneal Forcep
 Very Delicate 1 x 2 Teeth



Catalog #	Size, Tip Size
FR-726-11	11 cm (4 1/4"), 0.12 mm



Harms-Colibri Corneal Forcep
 Very Delicate 1 x 2 Teeth With Tying Platform



Catalog #	Size, Tip Size
FR-728-11	11 cm (4 1/4"), 0.12 mm



Eye Surgery Forceps
 Augen Chirurgie Pinzetten
 Ojo Pinzas Cirugia
 Pince de chirurgie oculaire
 Eye Pinze Chirurgia

Bonn Corneal Forcep
 Very Delicate 1 x 2 Teeth



Catalog #	Size, Tip Size
FR-730-08	8.5 cm (3 1/4"), 0.12 mm



Bonn Corneal Forcep
 Very Delicate 1 x 2 Teeth With Tying Platform



Catalog #	Size, Tip Size
FR-732-10	10 cm (4"), 0.12 mm



Bonn Corneal Forcep
 Very Delicate 1 x 2 Teeth With Tying Platform, Titanium



Catalog #	Size, Tip Size
FR-732-10 T	10 cm (4"), 0.12 mm



McPherson Suture Tying Forcep
 Straight, 1 x 2 Teeth With Tying Platform



Catalog #	Size, Tip Size
FR-736-10	10.5 cm (4"), 0.4 mm



McPherson Suture Tying Forcep
 Angled, 1 x 2 Teeth With Tying Platform



Catalog #	Size, Tip Size
FR-737-10	10 cm (4"), 0.4 mm



Eye Surgery Forceps
 Augen Chirurgie Pinzetten
 Ojo Pinzas Cirugia
 Pince de chirurgie oculaire
 Eye Pinze Chirurgia

Kelman-McPherson Tissue Forcep
 1 x 2 Teeth



Catalog #	Size, Jaw Length, Tip Size
FR-740-10	10 cm (4"), 8 mm, 0.3 mm



Hoffer-McPherson Tissue Forcep
 Very Delicate 1 x 2 Teeth



Catalog #	Size, Jaw Length, Tip Size
FR-742-10	10 cm (4"), 11 mm, 0.12 mm



Castroviejo Suture Tying Forcep
 1 x 2 Teeth With Tying Platform



Catalog #	Size, Tip Size
FR-750-01	11 cm (4 1/4"), 0.12 mm
FR-750-03	11 cm (4 1/4"), 0.3 mm
FR-750-05	11 cm (4 1/4"), 0.5 mm
FR-750-09	11 cm (4 1/4"), 0.9 mm



Castroviejo Suture Tying Forcep
 1 x 2 Teeth With Tying Platform, Titanium



Catalog #	Size, Tip Size
FR-750-01 T	11 cm (4 1/4"), 0.12 mm



Castroviejo Suture Tying Forcep
 Angled, 1 x 2 Teeth With Tying Platform



Catalog #	Size, Tip Size
FR-751-01	11 cm (4 1/4"), 0.12 mm
FR-751-03	11 cm (4 1/4"), 0.3 mm
FR-751-05	11 cm (4 1/4"), 0.5 mm
FR-751-09	11 cm (4 1/4"), 0.9 mm



Eye Surgery Forceps
 Augenchirurgie Pinzetten
 Ojo Pinzas Cirugia
 Pince de chirurgie oculaire
 Eye Pinze Chirurgia

Castroviejo Suture Tying Forcep
 Angled, 1 x 2 Teeth With Tying Platform, Titanium



Catalog #	Size, Tip Size
FR-751-01 T	11 cm (4 1/4"), 0.12 mm



1:2

Girard Corneoscleral Forcep
 1 x 2 Teeth With Tying Platform, For Right Hand



Catalog #	Size, Tip Size
FR-754-10	10.5 cm (4"), 0.12 mm



1:2

Girard Corneoscleral Forcep
 1 x 2 Teeth With Tying Platform, For Left Hand



Catalog #	Size, Tip Size
FR-756-10	10.5 cm (4"), 0.12 mm



1:2

Bishop-Harmon Iris Forcep
 Delicate 1 x 2 Teeth



Catalog #	Size
FR-758-08	8.5 cm (3 1/4")



1:2

Bishop-Harmon Iris Forcep
 Standard 1 x 2 Teeth



Catalog #	Size
FR-760-08	8.5 cm (3 1/4")



1:2

Eye Surgery Forceps
 Augen Chirurgie Pinzetten
 Ojo Pinzas Cirugia
 Pince de chirurgie oculaire
 Eye Pinze Chirurgia

Bishop-Harmon Dressing Forcep
 Cross Serrated Jaws



Catalog #	Size
FR-762-09	8.5 cm (3 1/4")

Sauer Fixation Forcep
 1 x 2 Teeth



Catalog #	Size, Tip Size
FR-766-09	9 cm (3 1/2"), 0.3 mm



Manhattan Eye & Ear Fixation Forcep
 1 x 2 Teeth With Tying Platform



Catalog #	Size, Tip Size
FR-768-09	9 cm (3 1/2"), 0.3 mm



Elschnig Fixation Forcep
 1 x 2 Teeth



Catalog #	Size
FR-770-11	11 cm (4 1/4")



Graefe Fixation Forcep



Catalog #	Size
FR-772-11	11 cm (4 1/4")

Eye Surgery Forceps
 Augenchirurgie Pinzetten
 Ojo Pinzas Cirugia
 Pince de chirurgie oculaire
 Eye Pinze Chirurgia

Troutman Superior Rectus Forcep
 Angled, 1 x 2 Teeth



Catalog #	Size
FR-774-11	11 cm (4 1/4")

McPherson Suture Tying Forcep
 Straight, With Tying Platform



Catalog #	Size, Jaw Length
FR-780-10	10 cm (4"), 5 mm

McPherson Suture Tying Forcep
 Straight, With Tying Platform, Titanium



Catalog #	Size, Jaw Length
FR-780-10 T	10 cm (4"), 5 mm

McPherson Suture Tying Forcep
 Angled, With Tying Platform



Catalog #	Size, Jaw Length
FR-781-10	10 cm (4"), 5 mm

McPherson Suture Tying Forcep
 Angled, With Tying Platform, Titanium



Catalog #	Size, Jaw Length
FR-781-10 T	10 cm (4"), 5 mm

Eye Surgery Forceps
 Augen Chirurgie Pinzetten
 Ojo Pinzas Cirugia
 Pince de chirurgie oculaire
 Eye Pinze Chirurgia

Kelman-McPherson Suture Tying Forcep
 Angled, With Tying Platform



Catalog #	Size, Jaw Length
FR-784-10	10 cm (4"), 7.5 mm

Kelman-McPherson Suture Tying Forcep
 Angled, With Tying Platform, Titanium



Catalog #	Size, Jaw Length
FR-784-10 T	10 cm (4"), 7.5 mm

Kurstin Flap Stretching Forcep
 Disc Shaped, Serrated Jaws



Catalog #	Size
FR-790-10	10.5 cm (4")

Buratto LASIK Flap Forcep
 Curved, Disc Shaped, Serrated Jaws



Catalog #	Size
FR-793-10	10.5 cm (4")

Mendez Multipurpose LASIK Forcep
 Angled, Spatulated Jaws & Tips



Catalog #	Size
FR-795-10	10 cm (4")

Eye Surgery Forceps
 Augenchirurgie Pinzetten
 Ojo Pinzas Cirugia
 Pince de chirurgie oculaire
 Eye Pinze Chirurgia

Kraff Capsule Tag Forcep
 Angled



Catalog #	Size, Shank Length, Jaw Length
FR-797-10	10.5 cm (4"), 11 mm, 1.5 mm

Utrata Capsulorhexis Forcep
 Very Delicate Triangular Grasping Tips, Extremely Thin



Catalog #	Size, Shank Length
FR-801-10	10.5 cm (4"), 11 mm

Utrata Capsulorhexis Forcep
 Very Delicate Triangular Grasping Tips, Extremely Thin, Titanium

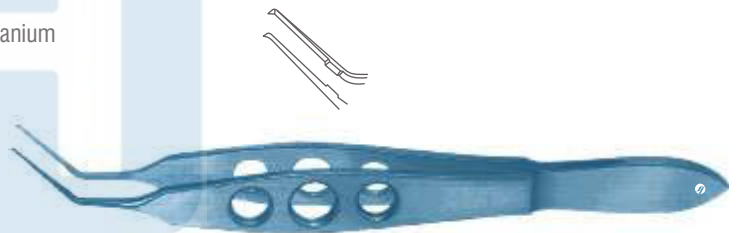

Catalog #	Size, Shank Length
FR-801-10 T	10.5 cm (4"), 11 mm

Jaffe Capsulorhexis Forcep
 Very Delicate Round Grasping Tips, Extremely Thin



Catalog #	Size, Shank Length
FR-803-10	10.5 cm (4"), 11 mm

Jaffe Suture Tying Forcep
 Straight, Very Delicate Smooth Jaws



Catalog #	Size, Jaw Length
FR-810-10	10.5 cm (4"), 6 mm

Eye Surgery Forceps
 Augenchirurgie Pinzetten
 Ojo Pinzas Cirugia
 Pince de chirurgie oculaire
 Eye Pinze Chirurgia

Jaffe Suture Tying Forcep
 Curved, Very Delicate Smooth Jaws



Catalog #	Size, Jaw Length
FR-811-10	10.5 cm (4"), 6 mm

Tennant Suture Tying Forcep
 Straight, Round Handle With Guide Pin, Extra Delicate Smooth Jaws



Catalog #	Size, Jaw Length
FR-816-10	10.5 cm (4"), 6 mm

Tennant Suture Tying Forcep
 Straight, Round Handle With Guide Pin, Extra Delicate Smooth Jaws, Titanium

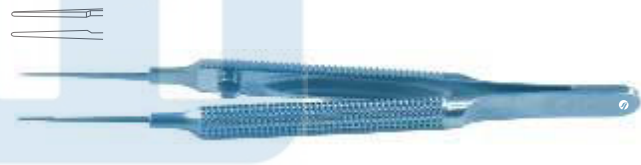

Catalog #	Size, Jaw Length
FR-816-10 T	10.5 cm (4"), 6 mm

Tennant Suture Tying Forcep
 Curved, Round Handle With Guide Pin, Extra Delicate Smooth Jaws



Catalog #	Size, Jaw Length
FR-817-10	10.5 cm (4"), 6 mm

Tennant Suture Tying Forcep
 Curved, Round Handle With Guide Pin, Extra Delicate Smooth Jaws, Titanium



Catalog #	Size, Jaw Length
FR-817-10 T	10.5 cm (4"), 6 mm

Eye Surgery Forceps
 Augenchirurgie Pinzetten
 Ojo Pinzas Cirugia
 Pince de chirurgie oculaire
 Eye Pinze Chirurgia

Harms Suture Tying Forcep
 Straight



Catalog #	Size
FR-820-10	10.5 cm (4")

Harms Suture Tying Forcep
 Curved



Catalog #	Size
FR-821-10	10.5 cm (4")

Helveston Suture Tying Forcep
 Straight



Catalog #	Size
FR-824-10	10.5 cm (4")

Fine Suture Tying Forcep
 Curved



Catalog #	Size
FR-825-10	10.5 cm (4")

Gerl Suture Tying Forcep
 Smooth Jaws, Curved Shank



Catalog #	Size, Jaw Length
FR-827-08	8.5 cm (3 1/4"), 6 mm

Eye Surgery Forceps
 Augenchirurgie Pinzetten
 Ojo Pinzas Cirugia
 Pince de chirurgie oculaire
 Eye Pinze Chirurgia

Gerl Suture Tying Forcep
 Smooth Jaws, Curved Shank, Titanium



Catalog #	Size, Jaw Length
FR-827-08 T	8.5 cm (3 1/4"), 6 mm

Gradle Cilia Forcep
 Smooth Jaws



Catalog #	Size
FR-830-10	10 cm (4")

Bonaccolto Conjunctival Forcep
 Longitudinal Serrated Jaws With Cross Serrated Tips



Catalog #	Size, Tip Size
FR-834-12	10.5 cm (4"), 1.2 mm
FR-834-17	10.5 cm (4"), 1.7 mm

Moorfield Conjunctival Forcep



Catalog #	Size
FR-838-10	10 cm (4")

Nugent Utility Forcep
 Smooth Jaws



Catalog #	Size
FR-840-10	10.5 cm (4")

Eye Surgery Forceps
 Augenchirurgie Pinzetten
 Ojo Pinzas Cirugia
 Pince de chirurgie oculaire
 Eye Pinze Chirurgia

Nugent Utility Forcep
 Serrated Jaws



Catalog #	Size
FR-842-10	10.5 cm (4")

Gold Punctal Plug Forcep
 With Longitudinal Groove, Pointed Tips



Catalog #	Size
FR-846-10	11 cm (4 1/4")

Osher Iris Forcep
 Very Fine Textured Jaws



Catalog #	Size
FR-848-11	11 cm (4 1/4")

Foreign Body Forcep
 Straight



Catalog #	Size
FR-850-11	8.5 cm (3 1/4")

Jaffe Utility Forcep
 Curved, Very Delicate Smooth Jaws



Catalog #	Size
FR-855-11	11 cm (4 1/4")

Eye Surgery Forceps
 Augen Chirurgie Pinzetten
 Ojo Pinzas Cirugia
 Pince de chirurgie oculaire
 Eye Pinze Chirurgia

Arruga Capsule Forcep



Catalog #	Size
FR-859-11	11 cm (4 1/4")

Akahoshi Phaco PreChopper

Delicate Jaws With Sharp Tips



Catalog #	Size, Jaw Length
FR-861-11	11 cm (4 1/4"), 4.5 mm

Ernest Nucleus Cracker

Extra Delicate Cross Action Serrated Paddle Tips



Catalog #	Size
FR-863-11	11 cm (4 1/4")

Dodick Nucleus Cracker

Cross Action, Longitudinally Serrated Paddle Shaped Jaws



Catalog #	Size
FR-867-11	11 cm (4 1/4")

Alfonso Nucleus Grasping Forcep

With Two Short Rows of Delicate Interlocking Teeth



Catalog #	Size
FR-869-10	10.5 cm (4")

Eye Surgery Forceps
 Augen Chirurgie Pinzetten
 Ojo Pinzas Cirugia
 Pince de chirurgie oculaire
 Eye Pinze Chirurgia

Rosenwasser Donor Lamella Inserting Forcep
 With Vaulted Shanks

Catalog #	Size
FR-871-11	11 cm (4 1/4")



Dodick IOL Folding Forcep
 For Short IOLs

Catalog #	Size
FR-875-11	11 cm (4 1/4")



Livernois IOL Folding Forcep
 Concave Jaw Surfaces, For Soft IOLs

Catalog #	Size
FR-877-10	10.5 cm (4")



Steinert IOL Inserting Forcep
 Conically Shaped Jaws

Catalog #	Size
FR-879-10	10 cm (4")



Livernois IOL Holding Forcep
 Straight, Highly Polished Round Jaws For Holding Soft IOLs

Catalog #	Size
FR-882-10	10.5 cm (4")



Eye Surgery Forceps
 Augen Chirurgie Pinzetten
 Ojo Pinzas Cirugia
 Pince de chirurgie oculaire
 Eye Pinze Chirurgia

Livernois IOL Holding Forcep

Curved, Highly Polished Round Jaws For Holding Soft IOLs

Catalog #	Size
FR-883-10	10.5 cm (4")



Livernois-McDonald IOL Inserting Forcep

Concave Jaws

Catalog #	Size, Jaw Length
FR-885-10	10.5 cm (4"), 5.0 mm



Faulkner Lens Holding Forcep

Round, Smooth Jaws

Catalog #	Size
FR-887-10	10 cm (4")



Buratto IOL Inserting Forcep

Extra Delicate Highly Polished Convex Jaws, For Soft IOLs

Catalog #	Size
FR-889-10	10 cm (4")



Bechert Lens Holding Forcep

Very Delicate Flat Jaws

Catalog #	Size
FR-891-12	12.5 cm (5")



Eye Surgery Forceps
 Augenchirurgie Pinzetten
 Ojo Pinzas Cirugia
 Pince de chirurgie oculaire
 Eye Pinze Chirurgia

Kratz Lens Holding Forcep
 Very Delicate Narrow Jaws



Catalog #	Size
FR-893-12	12.5 cm (5")

Blaydes Lens Holding Forcep
 Very Delicate Narrow Jaws, Angled 45°



Catalog #	Size
FR-895-11	11.5 cm (4 1/2")

Shepard Lens Holding Forcep
 Gently Curved, Duckbill Shaped Jaws



Catalog #	Size
FR-897-12	12.5 cm (5")

Clayman Lens Holding Forcep
 Gently Curved Blades with Delicately Angled Jaws



Catalog #	Size
FR-899-12	12.5 cm (5")

Jameson Muscle Forcep
 Right, with Slide Lock, 4 Teeth, Child Size



Catalog #	Size
FR-901-01	9.5 cm (3 3/4")

Eye Surgery Forceps
 Augen Chirurgie Pinzetten
 Ojo Pinzas Cirugia
 Pince de chirurgie oculaire
 Eye Pinze Chirurgia

Jameson Muscle Forcep

Left, with Slide Lock, 4 Teeth, Child Size

Catalog #	Size
FR-901-02	9.5 cm (3 ¾")



Jameson Muscle Forcep

Right, with Slide Lock, 6 Teeth, Adult Size

Catalog #	Size
FR-903-01	10 cm (4")



Jameson Muscle Forcep

Left, with Slide Lock, 6 Teeth, Adult Size

Catalog #	Size
FR-903-02	10 cm (4")



Berke Ptosis Forcep

Longitudinally Grooved Jaws, with Side Lock

Catalog #	Size, Jaw Length
FR-905-20	11 cm (4 ¼"), 20 mm



Berke Ptosis Forcep

Longitudinally Grooved Jaws, with Side Lock

Catalog #	Size, Jaw Length
FR-905-27	11 cm (4 ¼"), 27 mm



Eye Surgery Forceps
 Augenchirurgie Pinzetten
 Ojo Pinzas Cirugia
 Pince de chirurgie oculaire
 Eye Pinze Chirurgia

Erhardt Lid Forcep



Catalog #	Size
FR-908-10	10.5 cm (4")

Downes Lid Clamp



Catalog #	Size
FR-910-09	9.5 cm (3 3/4")

Lambert Chalazion Forcep Round Jaws



Catalog #	Size, Jaw Diameter
FR-912-08	9 cm (3 1/2"), Ø 8.0 mm

Hunt Chalazion Forcep Round Jaws



Catalog #	Size, Jaw Diameter
FR-912-12	9.5 cm (3 3/4"), Ø 12.0 mm

Baird Chalazion Forcep Small, Oval Jaws



Catalog #	Size, Jaw Size
FR-914-09	9.5 cm (3 3/4"), 11 x 8 mm

Eye Surgery Forceps
 Augen Chirurgie Pinzetten
 Ojo Pinzas Cirugia
 Pince de chirurgie oculaire
 Eye Pinze Chirurgia

Francis Chalazion Forcep
 Medium, Oval Jaws



Catalog #	Size, Jaw Size
FR-916-09	9.5 cm (3 ¾"), 14 x 11 mm

Desmarres Chalazion Forcep
 Large, Oval Jaws



Catalog #	Size, Jaw Size
FR-918-09	9.5 cm (3 ¾"), 20 x 13 mm

Wies Chalazion Forcep
 Grooved Upper Jaws



Catalog #	Size
FR-920-09	9.5 cm (3 ¾")

Desmarres Entropian Forcep
 Right



Catalog #	Size
FR-923-01	10 cm (4")

Desmarres Entropian Forcep
 Left



Catalog #	Size
FR-923-02	10 cm (4")

Tissue Forceps, Dissecting Forceps
 Chirurgische Pinzetten, Anatomische Pinzetten
 Pinzas de disección con diente, Pinzas de disección
 Pincès à dissection à griffes, Pincès à dissection
 Pinze per dissezione con denti, Pinze per dissezione

UltraGrip™ TC Bonney Dissecting Forcep
 1 x 2 Teeth



Catalog #	Size
FR-940-17	17.5 cm (7")



UltraGrip™ TC Gerald Dissecting Forcep
 1 x 2 Teeth



Catalog #	Size
FR-942-17	17.5 cm (7")



UltraGrip™ TC Gillies Dissecting Forcep
 1 x 2 Teeth



Catalog #	Size
FR-944-15	15.5 cm (6")



UltraGrip™ TC McIndoe Dressing Forcep



Catalog #	Size
FR-946-15	15 cm (6")



UltraGrip™ TC Semken Dissecting Forcep
 1 x 2 Teeth



Catalog #	Size
FR-950-16	16 cm (6 1/4")
FR-950-18	18 cm (7")



Tissue Forceps, Dissecting Forceps
 Chirurgische Pinzetten, Anatomische Pinzetten
 Pinzas de disección con diente, Pinzas de disección
 Pinces à dissection à griffes, Pinces à dissection
 Pinze per dissezione con denti, Pinze per dissezione

UltraGrip™ TC Micro-Semken Dissecting Forcep
 1 x 2 Teeth

ULTRAGripX™

Catalog #	Size
FR-952-16	16 cm (6 ¼")
FR-952-18	18 cm (7")



UltraGrip™ TC Adson-Brown Dissecting Forcep

ULTRAGripX™

Catalog #	Size
FR-956-12	12 cm (4 ¾")

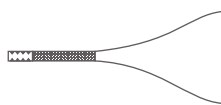

UltraGrip™ TC Micro-Adson Dissecting Forcep
 1 x 2 Teeth

ULTRAGripX™

Catalog #	Size
FR-958-12	12 cm (4 ¾")
FR-958-15	15 cm (6")



UltraGrip™ TC Adson Dressing Forcep

ULTRAGripX™

Catalog #	Size
FR-960-12	12 cm (4 ¾")
FR-960-15	15 cm (6")

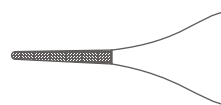

UltraGrip™ TC Adson Dissecting Forcep
 1 x 2 Teeth

ULTRAGripX™

Catalog #	Size
FR-962-12	12 cm (4 ¾")
FR-962-15	15 cm (6")

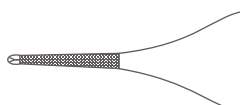

Tissue Forceps, Dissecting Forceps
 Chirurgische Pinzetten, Anatomische Pinzetten
 Pinzas de disección con diente, Pinzas de disección
 Pincès à dissection à griffes, Pincès à dissection
 Pinze per dissezione con denti, Pinze per dissezione

UltraGrip™ TC Cushing Dressing Forcep
 Straight



Catalog #	Size
FR-966-17	17.5 cm (7")
FR-966-21	21 cm (8 ¼")

UltraGrip™ TC Cushing Dressing Forcep
 Angled

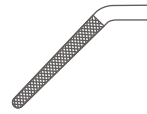

Catalog #	Size
FR-967-17	17 cm (6 ¾")

UltraGrip™ TC Cushing-Taylor Dressing Forcep
 Bayonet Shaped



Catalog #	Size
FR-969-17	18.5 cm (7 ¼")

UltraGrip™ TC Potts-Smith Dressing Forcep



Catalog #	Size
FR-972-15	16 cm (6 ¼")
FR-972-18	18.5 cm (7 ¼")
FR-972-20	20 cm (8")
FR-972-23	23 cm (9")
FR-972-25	25 cm (9 ¾")

Tissue Forceps, Dissecting Forceps
 Chirurgische Pinzetten, Anatomische Pinzetten
 Pinzas de disección con diente, Pinzas de disección
 Pincas à dissection à griffes, Pincas à dissection
 Pinze per dissezione con denti, Pinze per dissezione

UltraGrip™ TC Oehler Dissecting Forcep
 1 x 2 Teeth

ULTRAGrip™

Catalog #	Size
FR-974-14	14.5 cm (5 ¾")
FR-974-16	16 cm (6 ¼")
FR-974-18	18 cm (7")
FR-974-20	20 cm (8")
FR-974-25	25 cm (9 ¾")



UltraGrip™ TC Ferris-Smith Dissecting Forcep
 2 x 3 Teeth

ULTRAGrip™

Catalog #	Size
FR-978-17	17.5 cm (7")

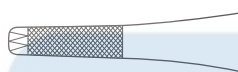

UltraGrip™ TC Wangenstein Dressing Forcep

ULTRAGrip™

Catalog #	Size
FR-980-15	15 cm (6")
FR-980-23	23 cm (9")



UltraGrip™ TC DeBakey Atrauma Forcep

ULTRAGrip™

Catalog #	Size, Tip Size
FR-990-16	16 cm (6 ¼"), 1.6 mm
FR-990-20	20 cm (8"), 1.6 mm
FR-990-24	24.5 cm (9 ¾"), 1.6 mm



Tissue Forceps, Dissecting Forceps
 Chirurgische Pinzetten, Anatomische Pinzetten
 Pinzas de disección con diente, Pinzas de disección
 Pincas à dissection à griffes, Pincas à dissection
 Pinze per dissezione con denti, Pinze per dissezione

UltraGrip™ TC DeBakey Atrauma Forcep



Catalog #	Size, Tip Size
FR-992-16	16 cm (6 ¼"), 2.0 mm
FR-992-20	20 cm (8"), 2.0 mm
FR-992-24	24.5 cm (9 ¾"), 2.0 mm



HOSPITA®

ALWAYS THE BEST

AF



ARTERY FORCEPS

Hospita artery forceps are manufactured by prime-grade surgical stainless steel by fine master craftsmen with intricate knowledge and focus on surgeon specific needs. The serrations of varying lengths and specifications enable the surgeon to perfectly clamp and restrict arteries or tissue, to control the flow of blood. The perfect alignment of the jaws and smooth round edges help deliver perfect results every time.



Arterienklemmen

Pinzas hemostáticas

Pinces hémostatiques

Pinze emostatiche

Clip Applying Forceps, Vessel Clips
 Clip-Anlegepinzette, Gefäßclips
 Pinzas para aplicar clips
 Pincas pour poser les clips vasculaires, Clips vasculaires
 Pinze per applicazione clips vascolari

Biemer Clip Applying Forcep
 Without Lock



Catalog #	Size
AF-010-14	14.5 cm (5 3/4")

Biemer Clip Applying Forcep
 With Lock



Catalog #	Size
AF-012-14	14.5 cm (5 3/4")

Biemer Vessel Clip



Catalog #	Size, Opening, Jaw Length, Closing Pressure
AF-016-14	14 mm, 4 mm, 4 mm, 30 - 40 gr

Biemer Vessel Clip



Catalog #	Size, Opening, Jaw Length, Closing Pressure
AF-018-17	17 mm, 7 mm, 5 mm, 30 - 40 gr

Biemer Vessel Clip



Catalog #	Size, Opening, Jaw Length, Closing Pressure
AF-020-17	17 mm, 7 mm, 5 mm, 20 - 25 gr

Vessel Clips, Approximators
 Gefäßclips, Approximatoren
 Clips vasculares, Aproximadores
 Clips vasculaires, Approximateurs
 Clip vascolari, Approssimatori

Biemer-Mueller Approximator
 Straight, Wide

Catalog #	Size, Opening, Jaw Length, Closing Pressure
AF-024-17	17 mm, 5 mm, 9 mm, 25 - 30 gr

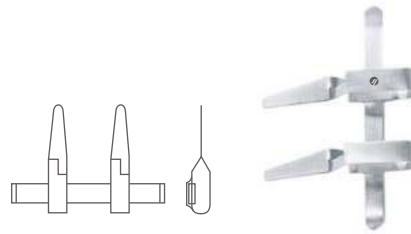

Biemer-Mueller Approximator
 Angled, Wide

Catalog #	Size, Opening, Jaw Length, Closing Pressure
AF-025-17	17 mm, 5 mm, 9 mm, , 25 - 30 gr

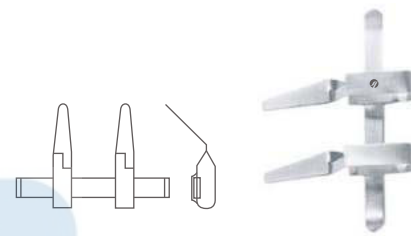

Biemer-Mueller Approximator
 Straight, Narrow

Catalog #	Size, Opening, Jaw Length, Closing Pressure
AF-026-13	13 mm, 3 mm, 4.5 mm, 25 - 30 gr
AF-026-17	17 mm, 5 mm, 9 mm, , 25 - 30 gr

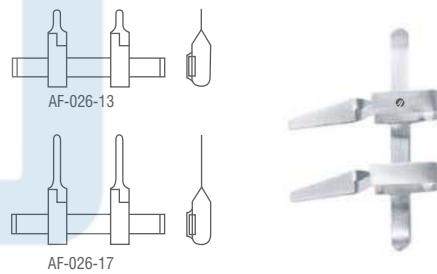

Biemer-Mueller Approximator
 Angled, Narrow

Catalog #	Size, Opening, Jaw Length, Closing Pressure
AF-027-17	17 mm, 5 mm, 9 mm. 25 - 30 gr

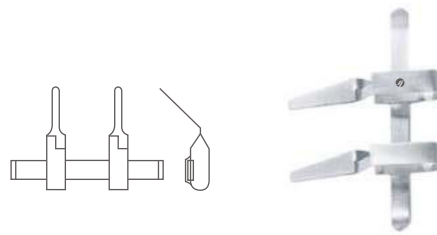

Approximators, Nerve Approximators
 Approximatoren, Nerv-Approximatoren
 Aproximadores, Aproximadores para nervios
 Approximateurs, Approximateurs pour nerfs
 Approssimatori, Approssimatori per nervi

Mueller Approximator

Catalog #	Size, Diameter, Closing Pressure
AF-030-01	17 mm, Ø 1 mm, 25 - 30 gr
AF-030-02	17 mm, Ø 2 mm, 25 - 30 gr
AF-030-03	17 mm, Ø 3 mm, 25 - 30 gr
AF-030-04	17 mm, Ø 4 mm, 25 - 30 gr

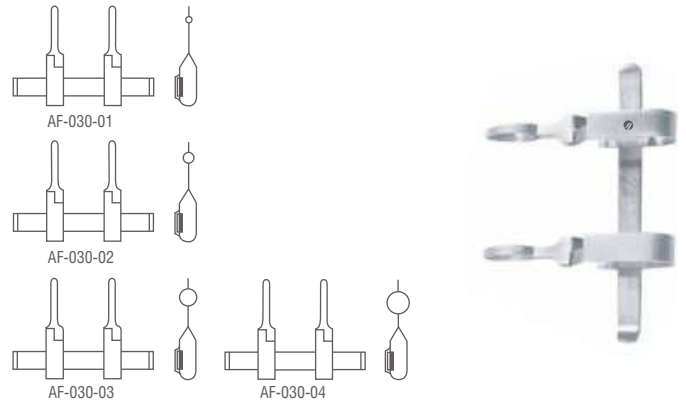

Nerve Approximator
 Complete With Key

Catalog #	Size
AF-040-00	Standard



Key For Approximator

Catalog #	Size
AF-040-01	Standard



Nerve Approximator
 Approximator Only

Catalog #	Size
AF-040-02	Standard



Nerve Approximator- Complete With Key
 Needles Exchangeable by Mean of Key

Catalog #	Size
AF-044-00	Standard



Mini Vessel Clips, Clip Applying Forceps
 Mini-Gefäßclips, Clip-Anlegezangen, Bulldogklemmen
 Mini Clips vasculares, Pinzas para aplicar clips
 Micro-clips vasculaires, Pinces pour poser micro-clips
 Mini-clip vascolari, Pinze per applicare clips vascolari

Nerve Approximator

Approximator With Needles Only

Catalog #	Size
AF-044-02	Standard

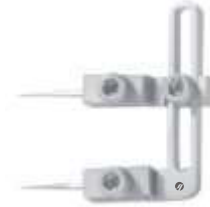

Nerve Approximator

Spare Needles Only

Catalog #	Size
AF-044-04	Standard



Clip Applying Forcep

With Ratchet

Catalog #	Size
AF-046-14	Standard



Clip Applying Forcep

Bayonet Shaped, With Ratchet

Catalog #	Size
AF-049-18	18.5 cm (7 1/4")



Mini Vessel Clip

Catalog #	Size, Jaw Size, Closing Pressure
AF-050-04	13 mm, 4.0 x 0.75 mm, 60 gr
AF-050-06	15 mm, 6.0 x 1.0 mm, 85 gr
AF-050-08	17 mm, 8.0 x 2.0 mm, 100 gr
AF-050-10	20 mm, 10.0 x 2.0 mm, 125 gr

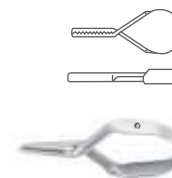

Bulldog Clamps
 Bulldogklemmen
 Clamps Bulldog
 Clamps Bulldog
 Pinze Bulldog

Dieffenbach Bulldog Clamp
 Straight

Catalog #	Size
AF-060-06	6 cm (2 1/4")



Dieffenbach Bulldog Clamp
 Curved

Catalog #	Size
AF-061-06	6 cm (2 1/4")



Dieffenbach Bulldog Clamp
 Straight

Catalog #	Size
AF-062-03	3.5 cm (1 1/2")
AF-062-05	5 cm (2")



Dieffenbach Bulldog Clamp
 Curved

Catalog #	Size
AF-063-03	3.5 cm (1 1/2")
AF-063-05	5 cm (2")



Bulldog Clamps
Bulldogklemmen
Clamps Bulldog
Clamps Bulldog
Pinze Bulldog

AF

ARTERY FORCEP

John-Hopkins Bulldog Clamp

Catalog #	Size
AF-065-35	3.5 cm (1 1/2")
AF-065-50	5 cm (2")
AF-065-55	5.5 cm (2 1/8")
AF-065-65	6.5 cm (2 1/2")
AF-065-70	7 cm (2 3/4")
AF-065-80	8 cm (3 1/4")
AF-065-90	9 cm (3 1/2")



John-Hopkins Clip Applying Forcep

Catalog #	Size
AF-067-24	24 cm (9 1/2")

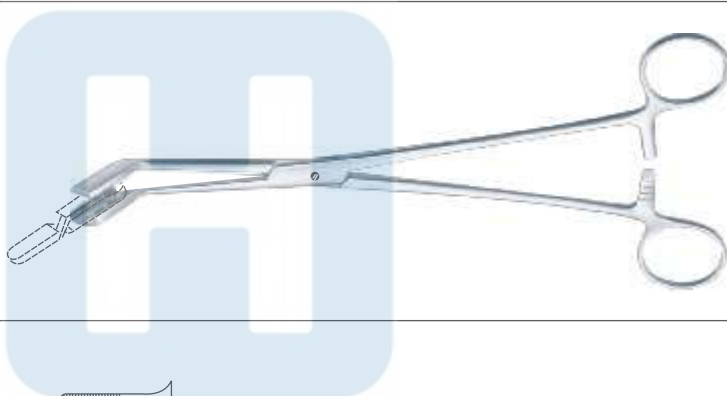

Diethrich Bulldog Clamp Straight

Catalog #	Size, Jaw Length
AF-080-45	45 mm, 8 mm
AF-080-50	50 mm, 12 mm
AF-080-60	60 mm, 20 mm



Diethrich Bulldog Clamp Angled

Catalog #	Size, Jaw Length
AF-081-40	45 mm, 8 mm
AF-081-45	50 mm, 12 mm
AF-081-50	60 mm, 20mm



Bulldog Clamps
Bulldogklemmen
Clamps Bulldog
Clamps Bulldog
Pinze Bulldog

DeBakey-Diethrich Atrauma Bulldog Clamp
Straight

Catalog #	Size, Jaw Length
AF-084-10	45 mm, 10 mm
AF-084-14	50 mm, 14 mm
AF-084-20	60 mm, 20mm

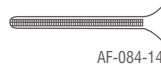

DeBakey-Diethrich Atrauma Bulldog Clamp
Straight, Titanium

Catalog #	Size, Jaw Length
AF-084-10 T	45 mm, 10 mm
AF-084-14 T	50 mm, 14 mm
AF-084-20 T	60 mm, 20mm



DeBakey-Diethrich Atrauma Bulldog Clamp
Angled

Catalog #	Size, Jaw Length
AF-085-10	35 mm, 10 mm
AF-085-14	45 mm, 14 mm
AF-085-20	50 mm, 20 mm

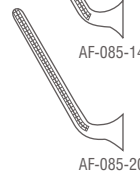
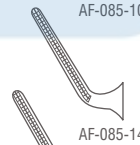
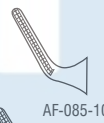

DeBakey-Diethrich Atrauma Bulldog Clamp
Angled, Titanium

Catalog #	Size, Jaw Length
AF-085-10 T	35 mm, 10 mm
AF-085-14 T	45 mm, 14 mm
AF-085-20 T	50 mm, 20mm

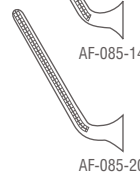
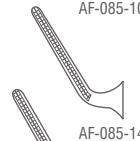

Bulldog Clamps
Bulldogklemmen
Clamps Bulldog
Clamps Bulldog
Pinze Bulldog

DeBakey-Hess Bulldog Clamp

Catalog #	Size, Jaw Length
AF-089-35	35 mm, 10 mm
AF-089-40	40 mm, 10 mm



Mini-Glover Vena Atrauma Bulldog Clamp Straight, Titanium

Catalog #	Size, Jaw Length
AF-090-30 T	30 mm, 9 mm
AF-090-35 T	35 mm, 13 mm
AF-090-40 T	40 mm, 14 mm
AF-090-50 T	50 mm, 23 mm



Mini-Glover Vena Atrauma Bulldog Clamp Gently Curved, Titanium

Catalog #	Size, Jaw Length
AF-091-30 T	30 mm, 9 mm
AF-091-35 T	35 mm, 13 mm
AF-091-40 T	40 mm, 14 mm
AF-091-50 T	50 mm, 23 mm



Mini-Glover Vena Atrauma Bulldog Clamp Strongly Curved, Titanium

Catalog #	Size, Jaw Length
AF-093-30 T	30 mm, 9 mm
AF-093-35 T	35 mm, 13 mm
AF-093-40 T	40 mm, 14 mm
AF-093-50 T	50 mm, 23 mm



Bulldog Clamps, Haemostatic Forceps
 Bulldogklemmen, Arterienklemmen
 Clamps Bulldog, Pinzas hemostáticas
 Clamps Bulldog, Pinces hémostatiques
 Pinze Bulldog, Pinze emostatiche

Mini-Glover Arteria Atrauma Bulldog Clamp
 Straight, Titanium

Catalog #	Size, Jaw Length
AF-096-30 T	30 mm, 9 mm
AF-096-35 T	35 mm, 13 mm
AF-096-40 T	40 mm, 14 mm
AF-096-50 T	50 mm, 23 mm

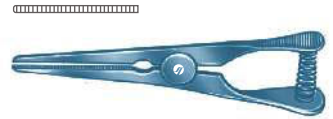

Mini-Glover Arteria Atrauma Bulldog Clamp
 Gently Curved, Titanium

Catalog #	Size, Jaw Length
AF-097-30 T	30 mm, 9 mm
AF-097-35 T	35 mm, 13 mm
AF-097-40 T	40 mm, 14 mm
AF-097-50 T	50 mm, 22 mm



Mini-Glover Arteria Atrauma Bulldog Clamp
 Strongly Curved, Titanium

Catalog #	Size, Jaw Length
AF-099-30 T	30 mm, 10mm
AF-099-35 T	35 mm, 14 mm
AF-099-40 T	40 mm, 15 mm
AF-099-50 T	50 mm, 21mm



Pean Haemostatic Forcep

Catalog #	Size
AF-110-14	14.5 cm (5 3/4")
AF-110-16	16 cm (6 1/4")

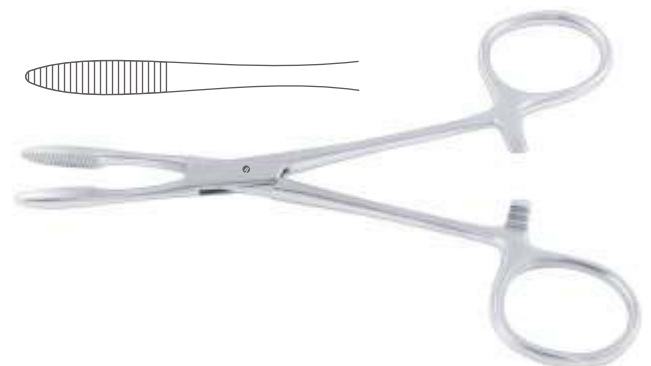

Haemostatic Forceps
Arterienklemmen
Pinzas hemostáticas
Pinces hémostatiques
Pinze emostatiche

AF

ARTERY FORCEP

Korenlein Haemostatic Forcep



Catalog #	Size
AF-112-13	13 cm (5")

Spencer-Wells Haemostatic Forcep Straight

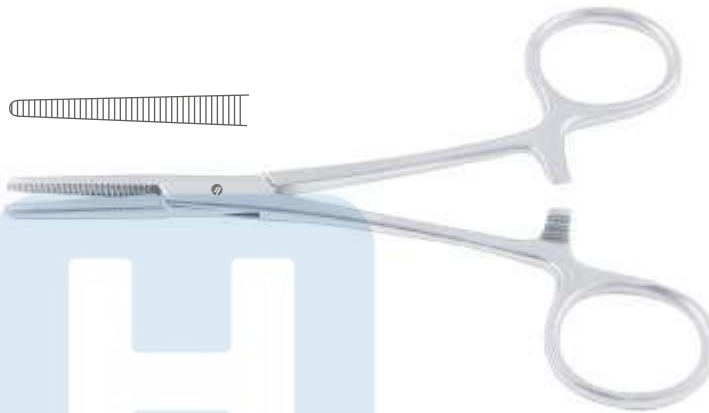

Catalog #	Size
AF-114-13	13 cm (5")
AF-114-14	14.5 cm (5 3/4")
AF-114-15	15.5 cm (6")
AF-114-18	18.5 cm (7 1/4")
AF-114-20	20 cm (8")

Spencer-Wells Haemostatic Forcep Curved



Catalog #	Size
AF-115-13	13 cm (5")
AF-115-14	14 cm (5 3/4")
AF-115-15	15 cm (6")
AF-115-18	18 cm (7 1/4")
AF-115-20	20 cm (8")

Chaput Haemostatic Forcep 2 x 3 Teeth



Catalog #	Size
AF-120-13	12.5 cm (5")

Haemostatic Forceps, Organ Grasping Forceps
 Arterienklemmen, Organfasszangen
 Pinzas hemostáticas, Pinzas para sacar órganos
 Pinces hémostatiques, Pinces pour saisir organes
 Pinze emostatiche, Pinze per afferrare organi

Tuffier Haemostatic Forcep
 4 x 5 Teeth

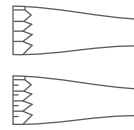

Catalog #	Size
AF-122-13	12.5 cm (5")

Atrauma Organ Grasping / Haemorrhoidal Forcep

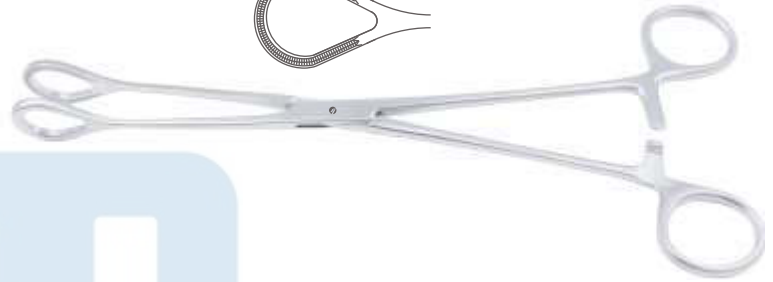
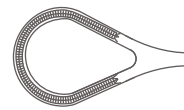

Catalog #	Size
AF-126-25	25 cm (9 3/4")
AF-126-26	26 cm (10 1/4")

Collin Organ Grasping Forcep

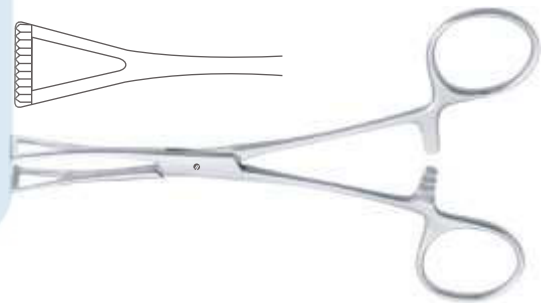
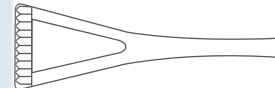

Catalog #	Size
AF-128-14	14 cm (5 1/2")

Collin Tumor Grasping Forcep

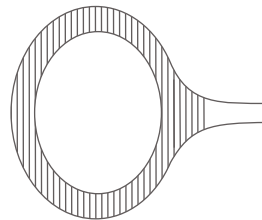

Catalog #	Size
AF-130-17	17 cm (6 3/4")

Pennington Organ Grasping Forcep

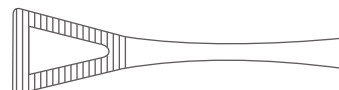

Catalog #	Size
AF-134-15	15.5 cm (6")
AF-134-20	21 cm (8 1/4")

Haemostatic Forceps
Arterienklemmen
Pinzas hemostáticas
Pinces hémostatiques
Pinze emostatiche

AF

ARTERY FORCEP

Pratt Haemostatic Forcep

Catalog #	Size
AF-136-15	15 cm (6")

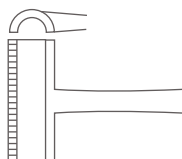

Martel-Rees Face-Lift Forcep

Catalog #	Size
AF-138-14	13.5 cm (5 1/4")

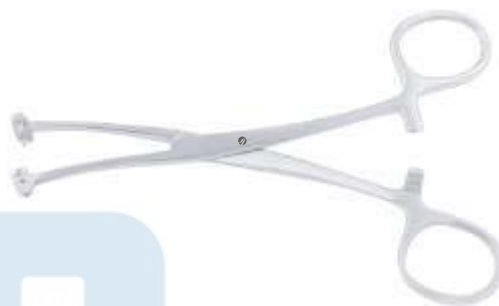
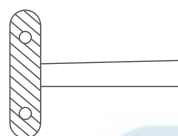

Hartmann Haemostatic Forcep Straight

Catalog #	Size
AF-140-10	10 cm (4")

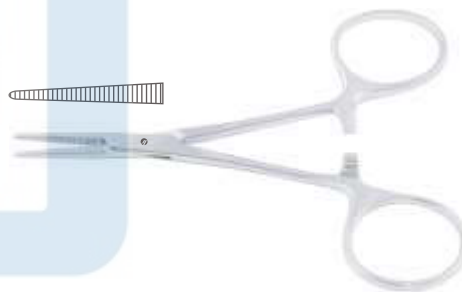

Hartmann Haemostatic Forcep Curved

Catalog #	Size
AF-141-10	9.5 cm (3 3/4")



Hartmann Haemostatic Forcep Straight, 1 x 2 Teeth

Catalog #	Size
AF-142-10	10 cm (4")



Haemostatic Forceps
 Arterienklemmen
 Pinzas hemostáticas
 Pinces hémostatiques
 Pinze emostatiche

Hartmann Haemostatic Forcep
 Curved, 1 x 2 Teeth

Catalog #	Size
AF-143-10	9.5 cm (3 ¾")



Haemostatic Forcep
 Cross Serrated Jaw

Catalog #	Size
AF-146-12	12.5 cm (5")



Carrel Haemostatic Forcep

Catalog #	Size
AF-148-08	8.5 cm (3 ¼")



Terrier Haemostatic Forcep
 1 x 2 Teeth

Catalog #	Size
AF-150-08	8.5 cm (3 ¼")



Halsted-Mosquito Haemostatic Forcep
 Straight

Catalog #	Size
AF-160-12	12.5 cm (4 ¾")
AF-160-14	14.5 cm (5 ½")



Haemostatic Forceps
Arterienklemmen
Pinzas hemostáticas
Pincas hémostatiques
Pinze emostatiche

AF

ARTERY FORCEP

Halsted-Mosquito Haemostatic Forcep
Curved



Catalog #	Size
AF-161-12	12 cm (4 ¾")
AF-161-14	14 cm (5 ½")

Halsted-Mosquito Haemostatic Forcep
Straight, 1 x 2 Teeth

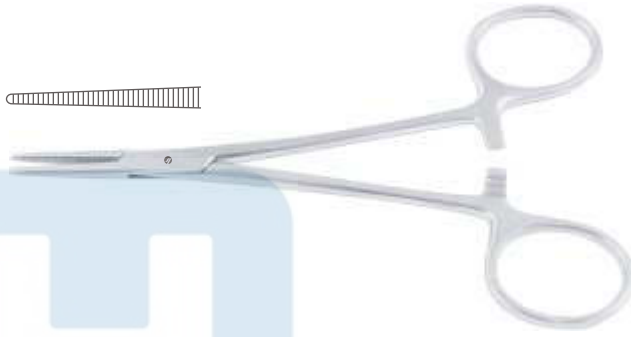

Catalog #	Size
AF-162-12	12.5 cm (4 ¾")
AF-162-14	14.5 cm (5 ¾")

Halsted-Mosquito Haemostatic Forcep
Curved, 1 x 2 Teeth

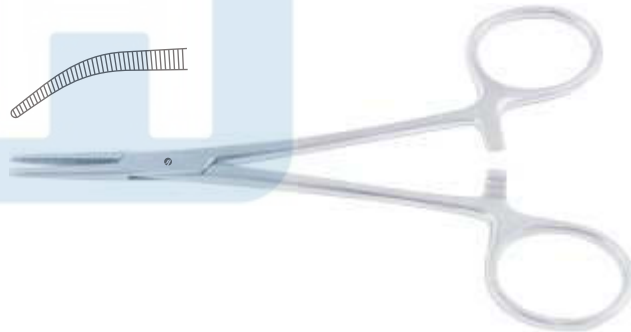

Catalog #	Size
AF-163-12	12 cm (4 ¾")
AF-163-14	14 cm (5 ½")

Micro-Mosquito Haemostatic Forcep
Straight



Catalog #	Size
AF-170-10	10 cm (4")
AF-170-12	12 cm (4 ¾")

Haemostatic Forceps
 Arterienklemmen
 Pinzas hemostáticas
 Pinces hémostatiques
 Pinze emostatiche

Micro-Mosquito Haemostatic Forcep Curved

Catalog #	Size
AF-171-10	9.5 cm (3 ¾")
AF-171-12	11.5 cm (4 ½")



Micro-Mosquito Haemostatic Forcep Straight, 1 x 2 Teeth

Catalog #	Size
AF-172-10	10 cm (4")
AF-172-12	12 cm (4 ¾")



Micro-Mosquito Haemostatic Forcep Curved, 1 x 2 Teeth

Catalog #	Size
AF-173-10	10 cm (4")
AF-173-12	12 cm (4 ¾")



Halsted-Mosquito Haemostatic Forcep Straight

Catalog #	Size
AF-176-18	18.5 cm (7 ¼")
AF-176-21	21 cm (8 ¼")



Haemostatic Forceps
Arterienklemmen
Pinzas hemostáticas
Pinces hémostatiques
Pinze emostatiche

Halsted-Mosquito Haemostatic Forcep
Curved



Catalog #	Size
AF-177-18	18 cm (7")
AF-177-21	20.5 cm (8")

Halsted-Mosquito Haemostatic Forcep
Straight, 1 x 2 Teeth

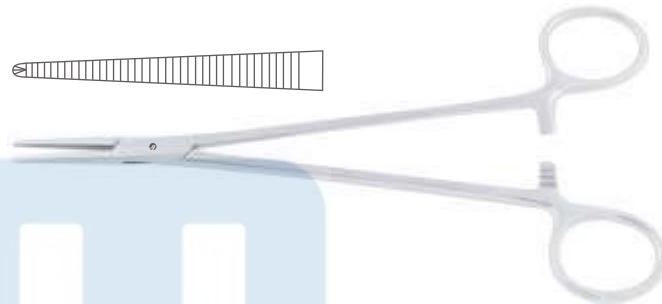

Catalog #	Size
AF-178-18	18.5 cm (7 1/4")
AF-178-21	21 cm (8 1/4")

Halsted-Mosquito Haemostatic Forcep
Curved, 1 x 2 Teeth

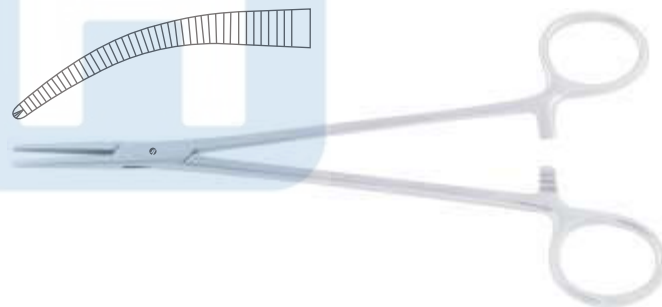

Catalog #	Size
AF-179-18	18 cm (7")
AF-179-21	21 cm (8")

Providence-Hospital Haemostatic Forcep
Straight

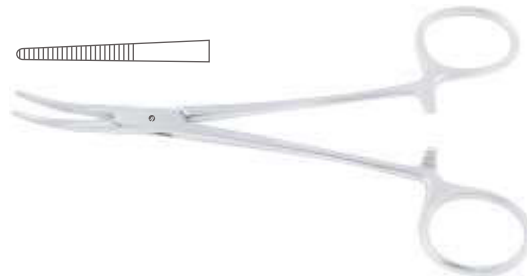

Catalog #	Size
AF-182-14	14 cm (5 1/2")

Providence-Hospital Haemostatic Forcep
Curved



Catalog #	Size
AF-183-14	14 cm (5 1/2")

Haemostatic Forceps
 Arterienklemmen
 Pinzas hemostáticas
 Pinces hémostatiques
 Pinze emostatiche

Leriche Haemostatic Forcep
 Straight

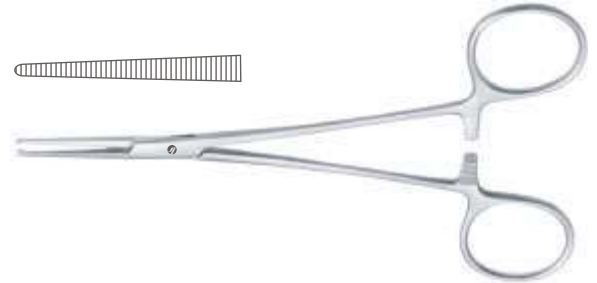

Catalog #	Size
AF-184-15	15.5 cm (6")

Leriche Haemostatic Forcep
 Curved



Catalog #	Size
AF-185-15	15 cm (6")

Leriche Haemostatic Forcep
 Straight, 1 x 2 Teeth



Catalog #	Size
AF-186-15	15.5 cm (6")

Leriche Haemostatic Forcep
 Curved, 1 x 2 Teeth



Catalog #	Size
AF-187-15	15 cm (6")

Kelly Haemostatic Forcep
 Straight

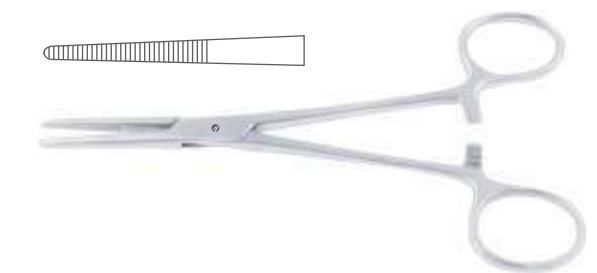

Catalog #	Size
AF-200-14	14.5 cm (5 3/4")

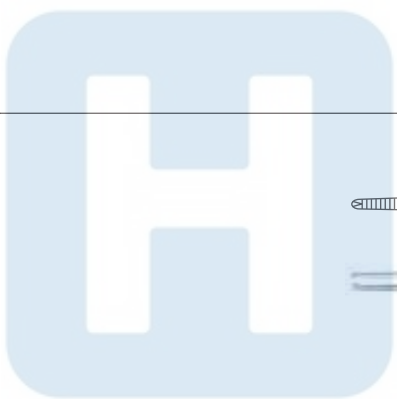

Haemostatic Forceps
Arterienklemmen
Pinzas hemostáticas
Pinces hémostatiques
Pinze emostatiche

AF

ARTERY FORCEP

Kelly Haemostatic Forcep
Curved

Catalog #	Size
AF-201-14	14 cm (5 ½")



Kelly-Rankin Haemostatic Forcep
Straight

Catalog #	Size
AF-202-16	16 cm (6 ¼")

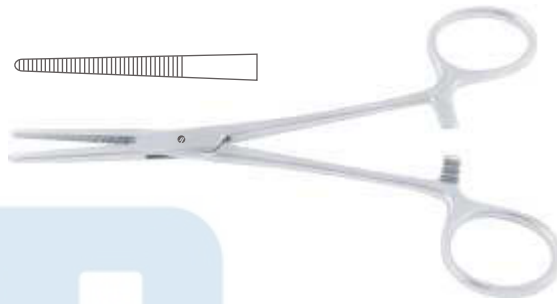

Kelly-Rankin Haemostatic Forcep
Curved

Catalog #	Size
AF-203-16	15.5 cm (6")

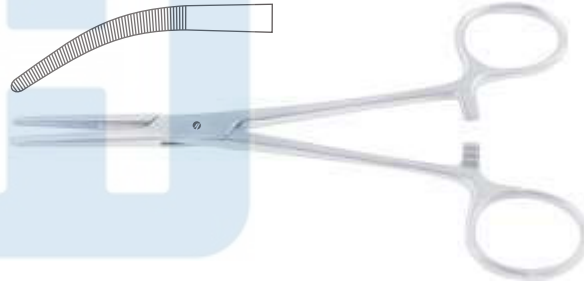

Crile Haemostatic Forcep
Straight

Catalog #	Size
AF-210-14	14.5 cm (5 ¾")



Crile Haemostatic Forcep
Curved

Catalog #	Size
AF-211-14	14 cm (5 ½")



Haemostatic Forceps
 Arterienklemmen
 Pinzas hemostáticas
 Pinces hémostatiques
 Pinze emostatiche

Crile Haemostatic Forcep
 Straight, 1 x 2 Teeth

Catalog #	Size
AF-212-14	14 cm (5 1/2")



Crile Haemostatic Forcep
 Curved, 1 x 2 Teeth

Catalog #	Size
AF-213-14	14 cm (5 1/2")



Crile-Rankin Haemostatic Forcep
 Straight

Catalog #	Size
AF-214-16	17 cm (6 3/4")



Crile-Rankin Haemostatic Forcep
 Curved

Catalog #	Size
AF-215-16	17 cm (6 3/4")

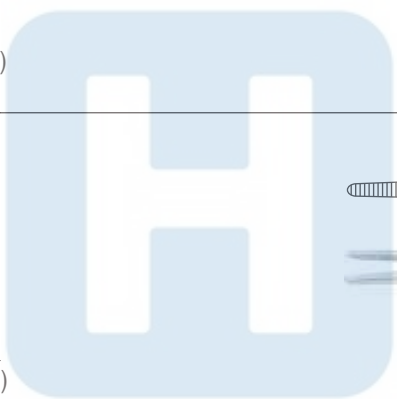

Haemostatic Forceps
Arterienklemmen
Pinzas hemostáticas
Pinces hémostatiques
Pinze emostatiche

AF

ARTERY FORCEP

Rochester-Pean Haemostatic Forcep
Straight

Catalog #	Size
AF-220-14	14.5 cm (5 ¾")
AF-220-16	16.5 cm (6 ½")
AF-220-18	18.5 cm (7 ¼")
AF-220-20	20.5 cm (8")
AF-220-22	22.5 cm (8 ¾")
AF-220-24	24.5 cm (9 ¾")
AF-220-26	26 cm (10 ¼")
AF-220-30	30.5 cm (12")

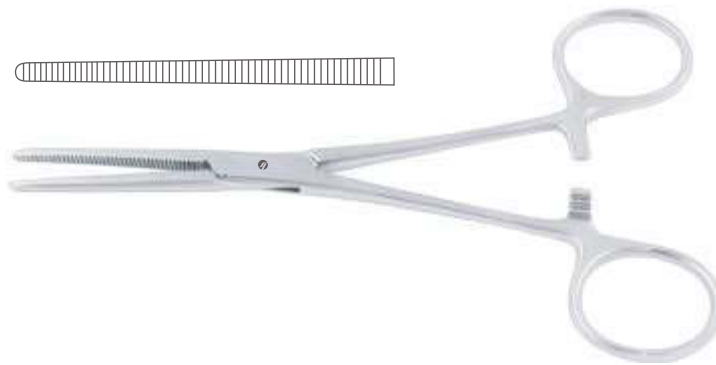

Rochester-Pean Haemostatic Forcep
Curved

Catalog #	Size
AF-221-14	14 cm (5 ½")
AF-221-16	16 cm (6 ¼")
AF-221-18	18 cm (7")
AF-221-20	20 cm (8")
AF-221-22	22 cm (8 ¾")
AF-221-24	24 cm (9 ½")
AF-221-26	25.5 cm (10")
AF-221-30	30 cm (11 ¾")

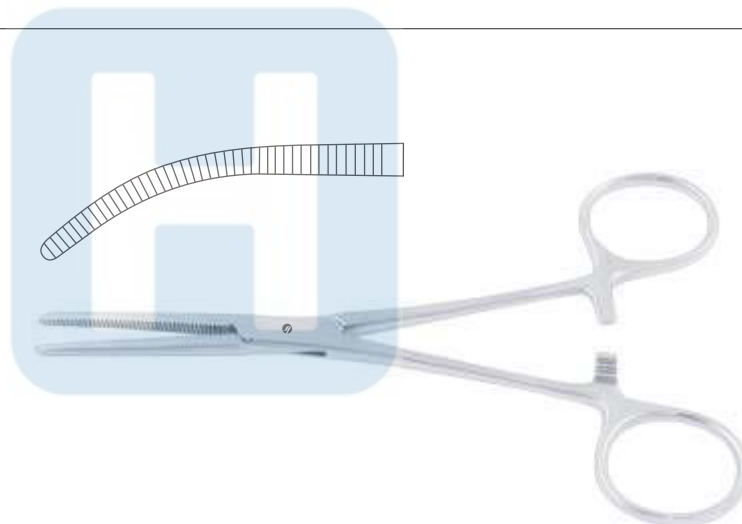

Ochsner-Kocher Haemostatic Forcep
Straight, 1 x 2 Teeth

Catalog #	Size
AF-230-14	14.5 cm (5 ¾")
AF-230-16	16.5 cm (6 ½")
AF-230-18	18.5 cm (7 ¼")
AF-230-20	20.5 cm (8")
AF-230-22	22.5 cm (8 ¾")
AF-230-24	24.5 cm (9 ¾")
AF-230-26	26 cm (10 ¼")
AF-230-30	30.5 cm (12")

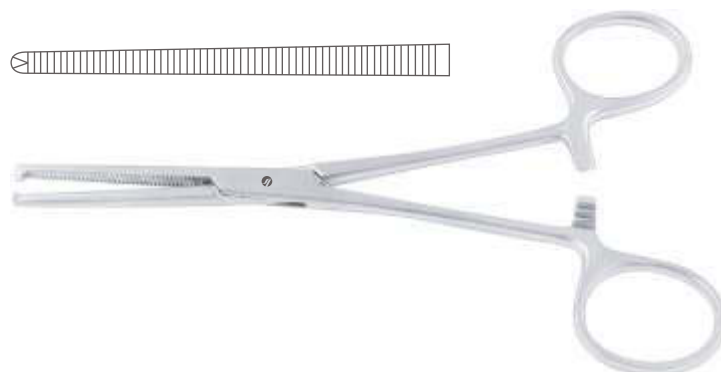

Haemostatic Forceps
 Arterienklemmen
 Pinzas hemostáticas
 Pinces hémostatiques
 Pinze emostatiche

Ochsner-Kocher Haemostatic Forcep
 Curved, 1 x 2 Teeth

Catalog #	Size
AF-231-14	14 cm (5 ½")
AF-231-16	16 cm (6 ¼")
AF-231-18	18 cm (7")
AF-231-20	20 cm (8")
AF-231-22	22 cm (8 ¾")
AF-231-24	24 cm (9 ½")
AF-231-26	25.5 cm (10 ")
AF-231-30	30 cm (11 ¾")

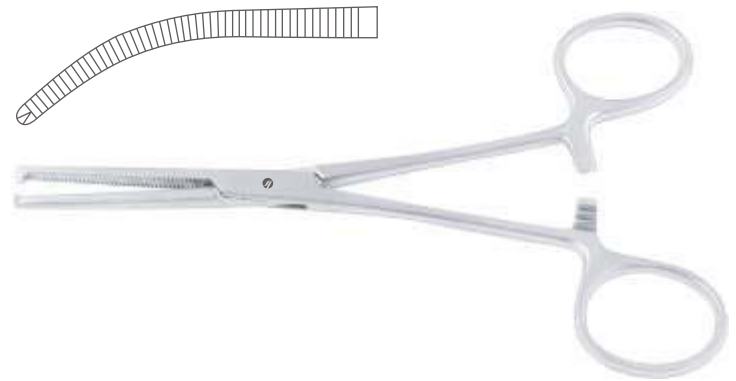

Rochester-Ochsner Haemostatic Forcep
 Straight

Catalog #	Size
AF-234-14	14 cm (5 ½")



Rochester-Ochsner Haemostatic Forcep
 Curved

Catalog #	Size
AF-235-14	14 cm (5 ½")



Kocher Haemostatic Forcep
 Straight, 1 x 2 Teeth

Catalog #	Size
AF-236-15	15 cm (6")

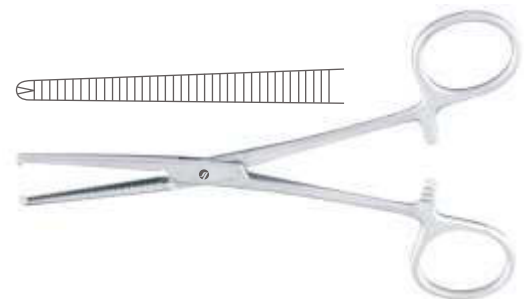

Haemostatic Forceps
Arterienklemmen
Pinzas hemostáticas
Pinces hémostatiques
Pinze emostatiche

AF

ARTERY FORCEP

Kocher Haemostatic Forcep
Curved, 1 x 2 Teeth

Catalog #	Size
AF-237-15	15 cm (6")

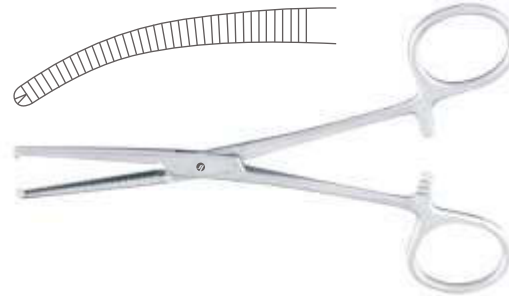

Pean-Nippon Haemostatic Forcep
Straight

Catalog #	Size
AF-240-14	14.5 cm (5 3/4")
AF-240-16	16.5 cm (6 1/2")
AF-240-18	18.5 cm (7 1/4")



Pean-Nippon Haemostatic Forcep
Curved

Catalog #	Size
AF-241-14	14 cm (5 1/2")
AF-241-16	16 cm (6 1/4")
AF-241-18	18 cm (7")

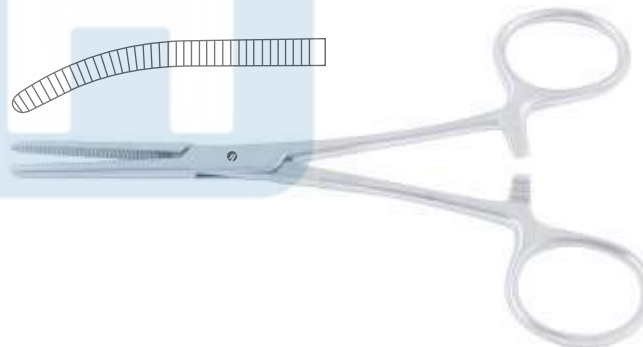

Kocher-Nippon Haemostatic Forcep
Straight, 1 x 2 Teeth

Catalog #	Size
AF-242-14	14.5 cm (5 3/4")
AF-242-16	16.5 cm (6 1/2")
AF-242-18	18.5 cm (7 1/4")



Haemostatic Forceps
 Arterienklemmen
 Pinzas hemostáticas
 Pinces hémostatiques
 Pinze emostatiche

Kocher-Nippon Haemostatic Forcep
 Curved, 1 x 2 Teeth

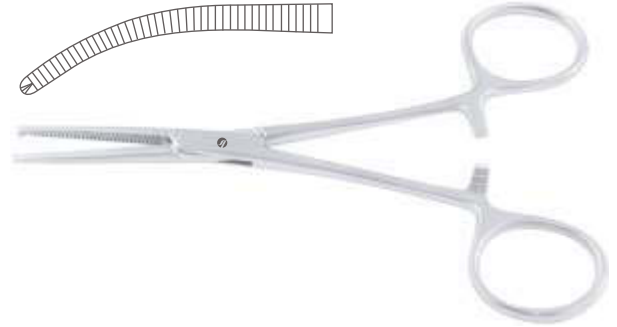

Catalog #	Size
AF-243-14	14.5 cm (5 ¾")
AF-243-16	16 cm (6 ¼")
AF-243-18	18 cm (7")

Pean (Delicate) Haemostatic Forcep
 Straight

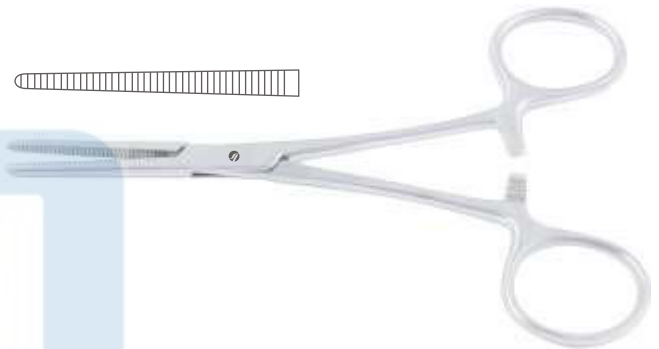

Catalog #	Size
AF-246-13	13.5 cm (5 ¼")
AF-246-14	14.5 cm (5 ¾")
AF-246-16	17 cm (6 ¾")

Pean (Delicate) Haemostatic Forcep
 Curved



Catalog #	Size
AF-247-13	13 cm (5")
AF-247-14	14 cm (5 ½")
AF-247-16	16.5 cm (6 ½")

Kocher (Delicate) Haemostatic Forcep
 Straight, 1 x 2 Teeth



Catalog #	Size
AF-248-13	13 cm (5")
AF-248-14	14 cm (5 ½")
AF-248-17	16 cm (6 ¼")

Haemostatic Forceps
Arterienklemmen
Pinzas hemostáticas
Pinces hémostatiques
Pinze emostatiche

AF

ARTERY FORCEP

Kocher (Delicate) Haemostatic Forcep
Curved, 1 x 2 Teeth



Catalog #	Size
AF-249-13	13 cm (5")
AF-249-14	14 cm (5 ½")
AF-249-16	16 cm (6 ¼")

Coller Haemostatic Forcep
Straight

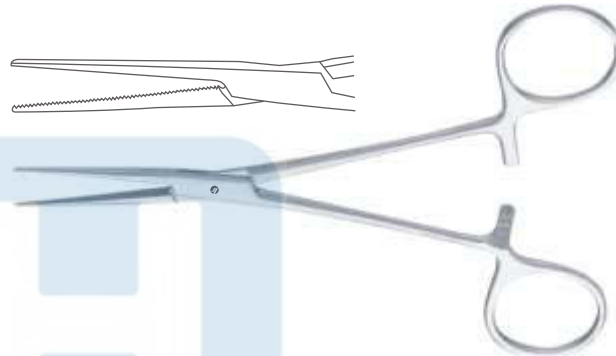

Catalog #	Size
AF-260-14	14 cm (5 ½")
AF-260-16	16.5 cm (6 ½")
AF-260-18	18.5 cm (7 ¼")

Coller Haemostatic Forcep
Curved

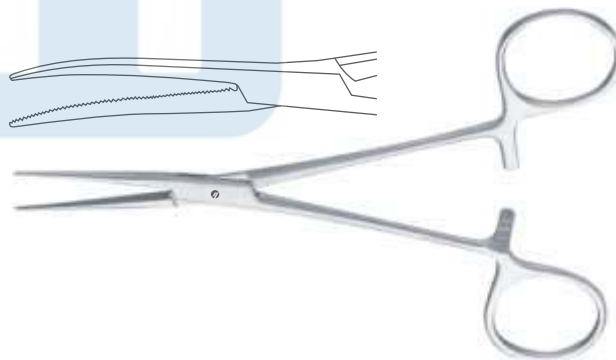

Catalog #	Size
AF-261-14	14 cm (5 ½")
AF-261-16	16.5 cm (6 ½")
AF-261-18	18.5 cm (7 ¼")

Fraser-Kelly (Crile) Haemostatic Forcep
Curved



Catalog #	Size
AF-265-18	18 cm (7")

Haemostatic Forceps
 Arterienklemmen
 Pinzas hemostáticas
 Pinces hémostatiques
 Pinze emostatiche

Adson Haemostatic Forcep
 Straight

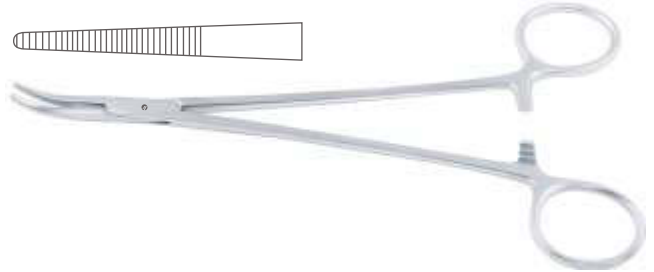

Catalog #	Size
AF-268-18	19 cm (7 1/2")

Adson Haemostatic Forcep
 Curved



Catalog #	Size
AF-269-18	18.5 cm (7 1/4")

Adson Haemostatic Forcep
 Curved

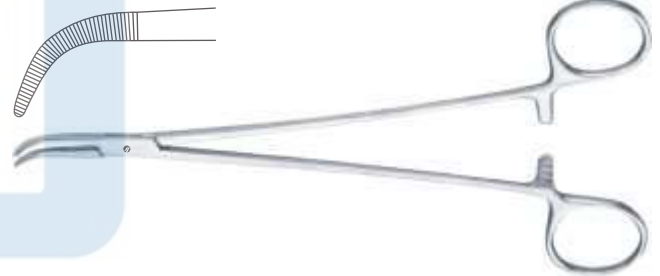

Catalog #	Size
AF-271-21	21.5 cm (8 1/2")

Jacobson Haemostatic Forcep
 Curved

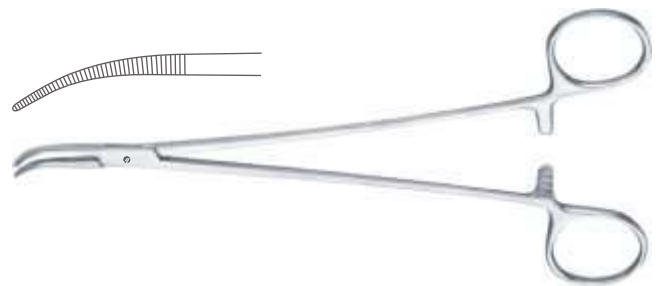

Catalog #	Size
AF-275-19	19 cm (7 1/2")

Dunhill Haemostatic Forcep
 Gently Curved

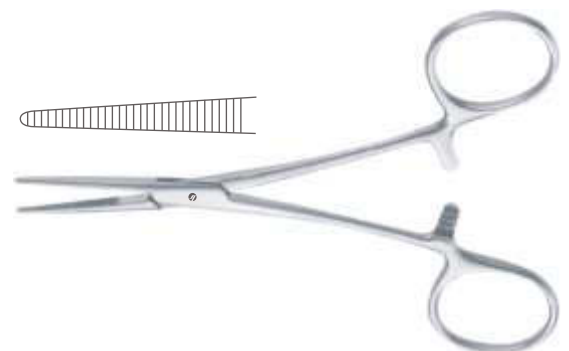

Catalog #	Size
AF-277-19	19 cm (7 1/2")

Haemostatic Forceps
Arterienklemmen
Pinzas hemostáticas
Pinces hémostatiques
Pinze emostatiche

AF

ARTERY FORCEP

Grey-Turner Haemostatic Forcep
Curved

Catalog #	Size
AF-279-19	18 cm (7")

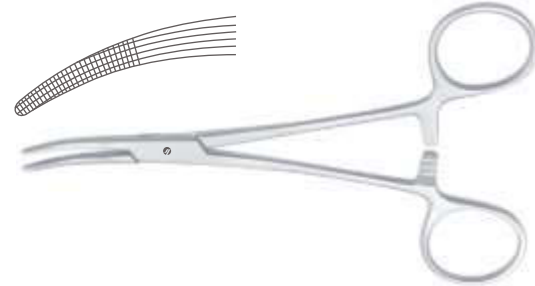

Dandy-Mosquito Haemostatic Forcep
Laterally Curved, Cross Serrated

Catalog #	Size
AF-281-12	12 cm (4 3/4")

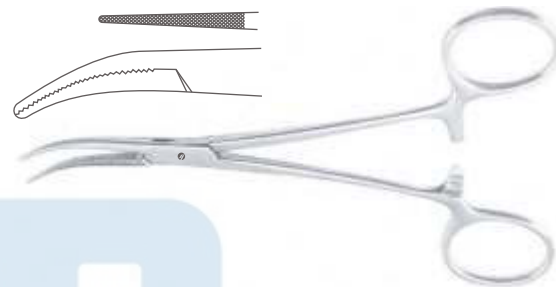

Dandy Haemostatic Forcep
Laterally Curved

Catalog #	Size
AF-283-14	14.5 cm (5 3/4")

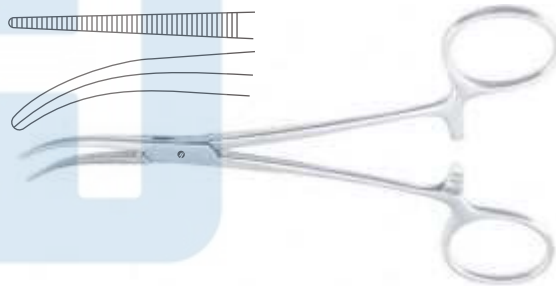

Dandy Haemostatic Forcep
Laterally Curved, 1 x 2 Teeth

Catalog #	Size
AF-285-14	14.5 cm (5 3/4")

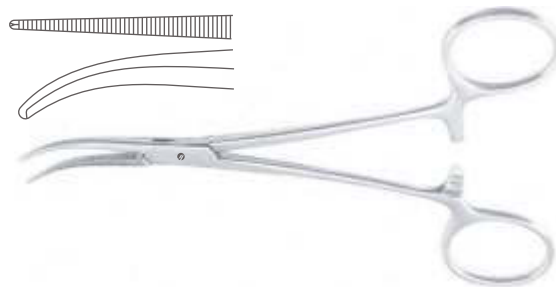

Cairns Haemostatic Forcep
Straight

Catalog #	Size
AF-290-15	15 cm (6")

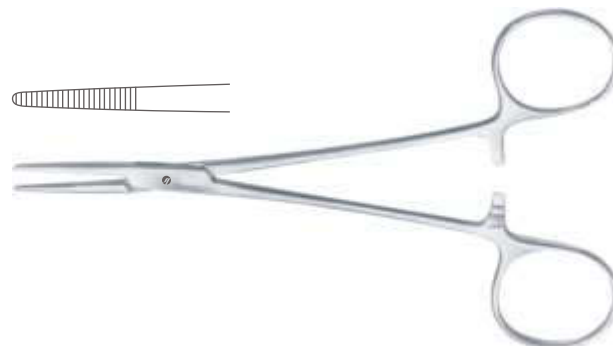

Haemostatic Forceps
 Arterienklemmen
 Pinzas hemostáticas
 Pinces hémostatiques
 Pinze emostatiche

Cairns Haemostatic Forcep
 Curved

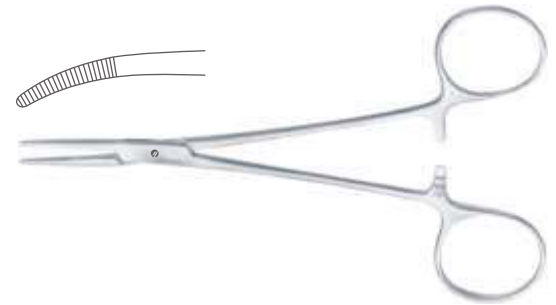

Catalog #	Size
AF-291-15	15 cm (6")

Cairns Haemostatic Forcep
 Curved to Side

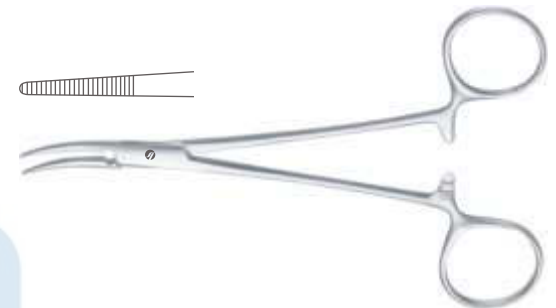

Catalog #	Size
AF-293-14	14.5 cm (5 3/4")

Dunhill Haemostatic Forcep
 Straight



Catalog #	Size
AF-295-13	13 cm (5")

Lovlace Haemostatic Forcep
 Straight, Cross Serrated



Catalog #	Size
AF-300-16	16 cm (6 1/4")

Lovlace Haemostatic Forcep
 Straight, Cross Serrated, 1 x 2 Teeth



Catalog #	Size
AF-302-16	16 cm (6 1/4")

Haemostatic Forceps
Arterienklemmen
Pinzas hemostáticas
Pinces hémostatiques
Pinze emostatiche

AF

ARTERY FORCEP

Martin-Fuchsig Haemostatic Forcep
Curved

Catalog #	Size
AF-305-20	20.5 cm (8")

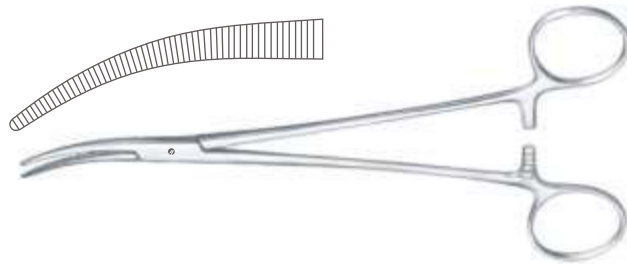

Nissen Haemostatic Forcep
Curved

Catalog #	Size
AF-307-18	18.5 cm (7 1/4")

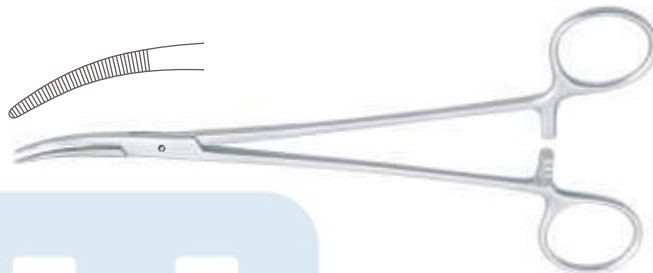

Schmidt Tonsil Haemostatic Forcep
Strongly Curved

Catalog #	Size
AF-311-01	18.5 cm (7 1/4")



Schmidt Tonsil Haemostatic Forcep
Gently Curved

Catalog #	Size
AF-311-02	19 cm (7 1/2")

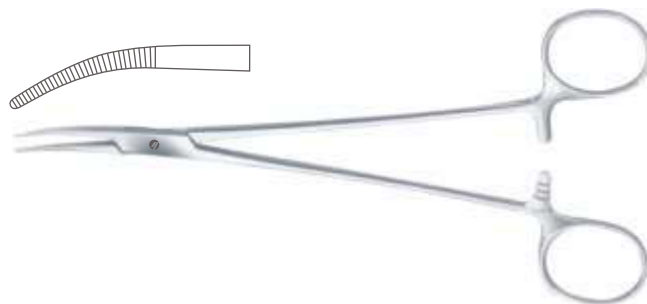

Negus Haemostatic Forcep
Fig. 1

Catalog #	Size
AF-315-01	19.5 cm (7 3/4")



Haemostatic Forceps
 Arterienklemmen
 Pinzas hemostáticas
 Pinces hémostatiques
 Pinze emostatiche

Negus Haemostatic Forcep
 Fig. 2



Catalog #	Size
AF-315-02	20 cm (8")

Wilson Haemostatic Forcep
 Curved

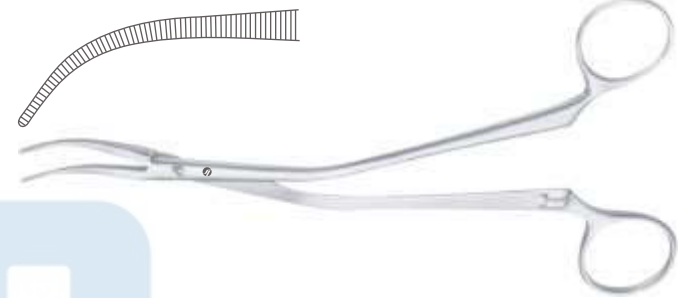

Catalog #	Size
AF-317-19	19 cm (7 1/2")

Rochester-Carmalt Haemostatic Forcep
 Straight



Catalog #	Size
AF-320-16	17 cm (6 3/4")
AF-320-20	20.5 cm (8")

Rochester-Carmalt Haemostatic Forcep
 Curved

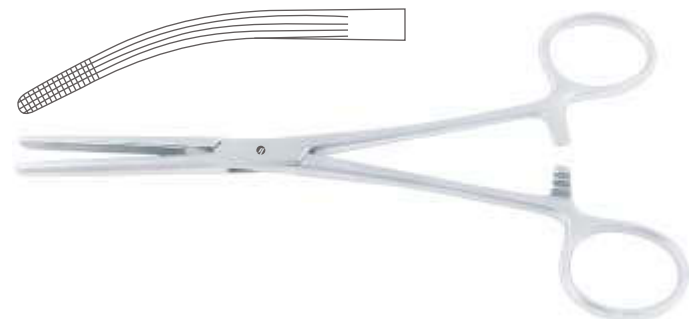

Catalog #	Size
AF-321-16	16.5 cm (6 1/2")
AF-321-20	20 cm (8")

Fickling Haemostatic Forcep

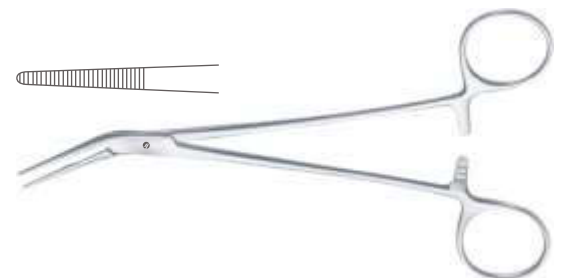

Catalog #	Size
AF-331-18	18 cm (7")

Haemostatic Forceps
Arterienklemmen
Pinzas hemostáticas
Pinces hémostatiques
Pinze emostatiche

AF

ARTERY FORCEP

Fickling Haemostatic Forcep

1 x 2 Teeth



Catalog #	Size
AF-333-18	18 cm (7")

Bainbridge Haemostatic Forcep

Straight, Longitudinally Serrated

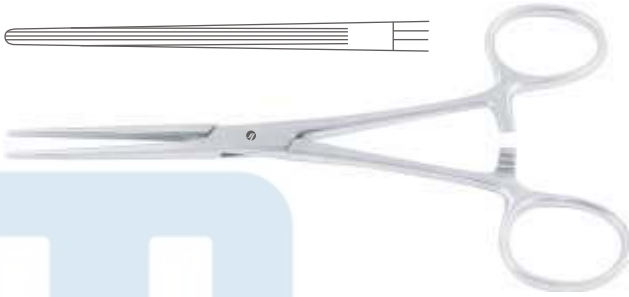

Catalog #	Size
AF-340-15	15 cm (6")
AF-340-18	18.5 cm (7 1/4")

Bainbridge Haemostatic Forcep

Curved, Longitudinally Serrated

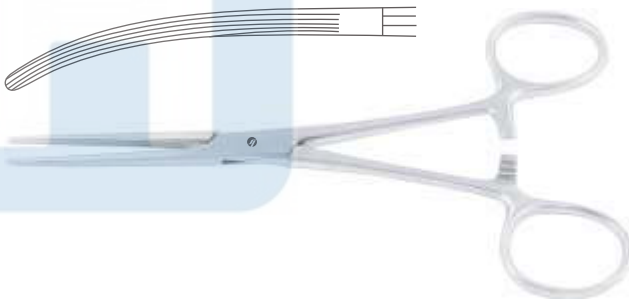

Catalog #	Size
AF-341-15	15 cm (6")
AF-341-18	18.5 cm (7 1/4")

Birkett Haemostatic Forcep

Straight



Catalog #	Size
AF-346-18	18.5 cm (7 1/4")

Birkett Haemostatic Forcep

Curved



Catalog #	Size
AF-347-18	18.5 cm (7 1/4")

Haemostatic Forceps
 Arterienklemmen
 Pinzas hemostáticas
 Pinces hémostatiques
 Pinze emostatiche

Bengolea Haemostatic Forcep
 Straight



Catalog #	Size
AF-350-20	21.5 cm (8 1/2")
AF-350-26	26 cm (10 1/4")

Bengolea Haemostatic Forcep
 Curved

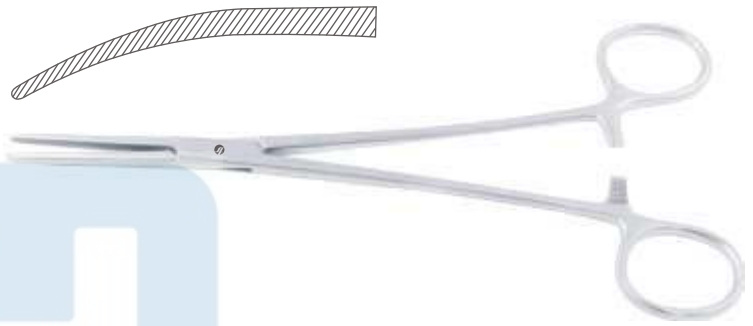

Catalog #	Size
AF-351-20	21 cm (8 1/4")
AF-351-26	25.5 cm (10")

Bengolea Haemostatic Forcep
 Straight, 1 x 2 Teeth

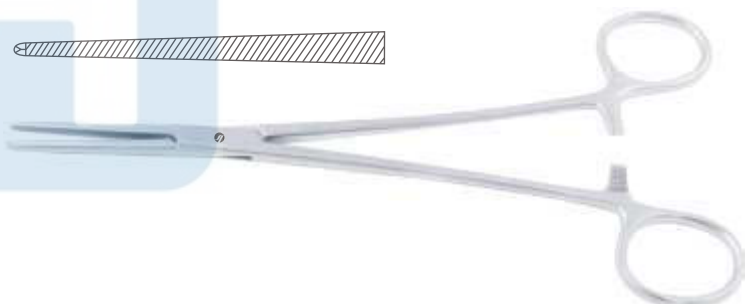

Catalog #	Size
AF-352-20	21.5 cm (8 1/2")
AF-352-26	26 cm (10 1/4")

Bengolea Haemostatic Forcep
 Curved, 1 x 2 Teeth

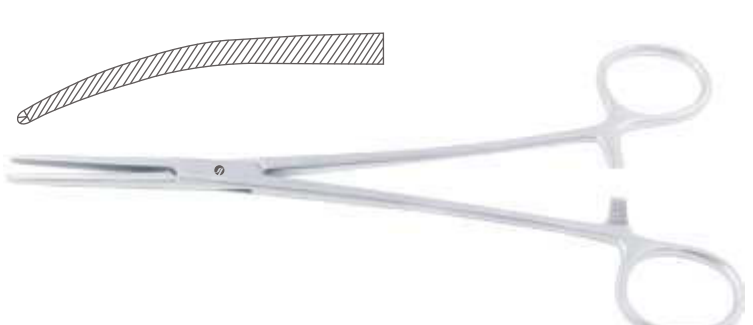

Catalog #	Size
AF-353-20	21 cm (8 1/4")
AF-353-26	25.5 cm (10")

Haemostatic Forceps
Arterienklemmen
Pinzas hemostáticas
Pinces hémostatiques
Pinze emostatiche

AF

ARTERY FORCEP

Roberts Haemostatic Forcep
Straight

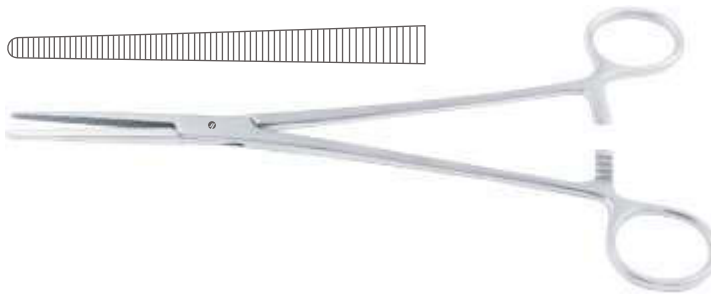

Catalog #	Size
AF-360-22	22.5 cm (8 ¾")

Roberts Haemostatic Forcep
Curved

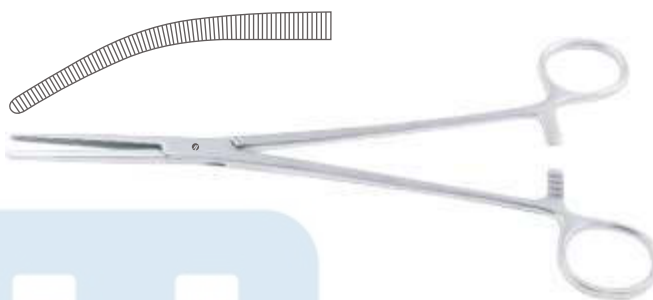

Catalog #	Size
AF-361-22	21.5 cm (8 ½")

Sarot Haemostatic Forcep
Straight

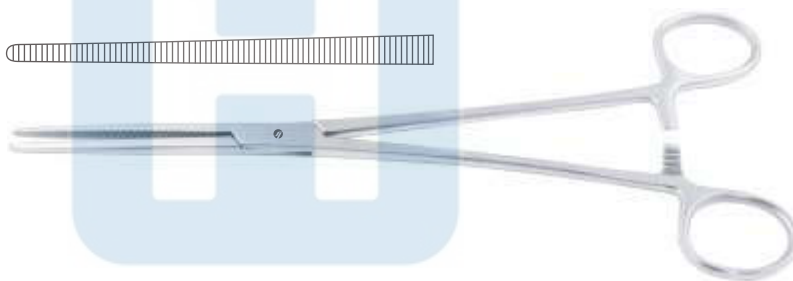

Catalog #	Size
AF-364-24	25 cm (9 ¾")

Sarot Haemostatic Forcep
Curved



Catalog #	Size
AF-365-24	24.5 cm (9 ¾")

Crafoord Haemostatic Forcep
Curved

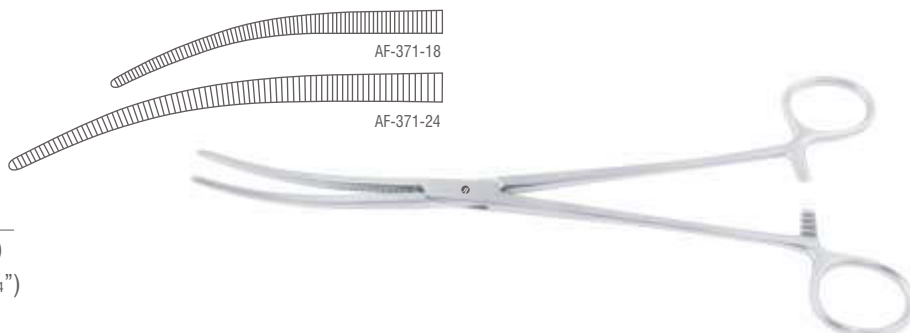

Catalog #	Size
AF-371-18	18 cm (9 ¾")
AF-371-24	24.5 cm (9 ¾")

Haemostatic Forceps
 Arterienklemmen
 Pinzas hemostáticas
 Pinces hémostatiques
 Pinze emostatiche

Crafoord- Sellors Haemostatic Forcep

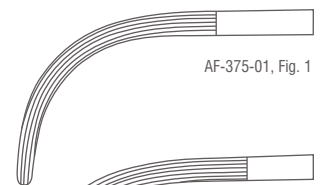

AF-375-01, Fig. 1



AF-375-02, Fig. 2



AF-375-03, Fig. 3

Catalog #	Size, Profile
AF-375-01	24 cm (9 1/2"), Fig. 1
AF-375-02	24 cm (9 1/2"), Fig. 2
AF-375-03	24 cm (9 1/2"), Fig. 3

Bridge Haemostatic Forcep
 Straight



Catalog #	Size
AF-380-27	27.5 cm (10 3/4")

Bridge Haemostatic Forcep
 Curved

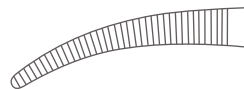

Catalog #	Size
AF-381-27	27.5 cm (10 3/4")

Dissecting and Ligature Forceps
 Präparierklemmen
 Pinzas para preparación y ligadura
 Pinces à disséquer et à ligatures
 Pinze per preparazioni e legature

Heiss Haemostatic Forcep

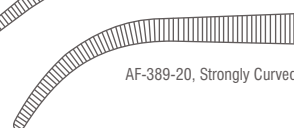
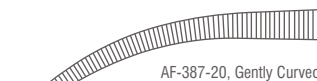

Catalog #	Size, Profile
AF-386-20	21 cm (8 1/4"), Straight
AF-387-20	20.5 cm (8"), Gently Curved
AF-389-20	20 cm (8"), Strongly Curved

Heiss Haemostatic Forcep
 Straight, 1 x 2 Teeth

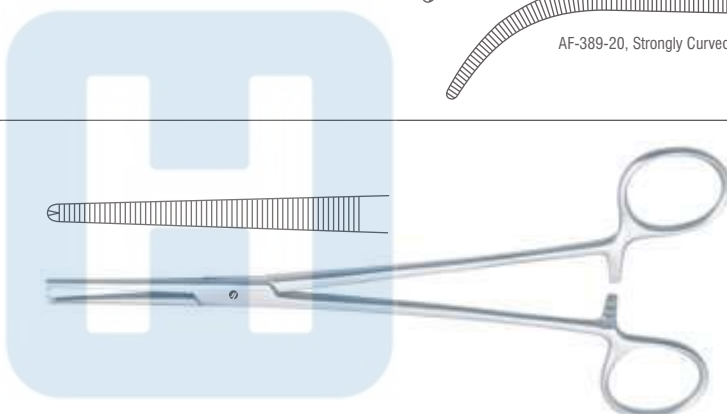

Catalog #	Size
AF-390-20	20 cm (8")

Heiss Haemostatic Forcep
 Curved, 1 x 2 Teeth

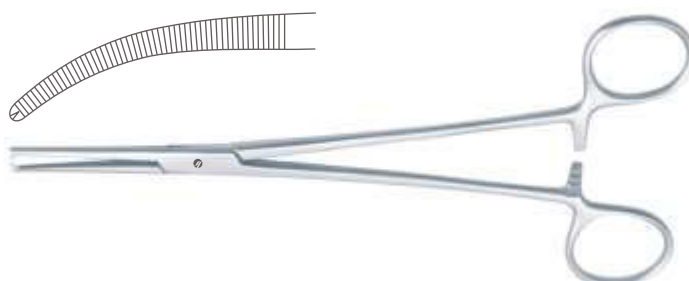

Catalog #	Size
AF-391-20	20 cm (8")

Dissecting and Ligature Forceps
 Präparierklemmen
 Pinzas para preparación y ligadura
 Pinces à disséquer et à ligatures
 Pinze per preparazioni e legature

Overholt-Martin Dissecting and Ligature Forcep

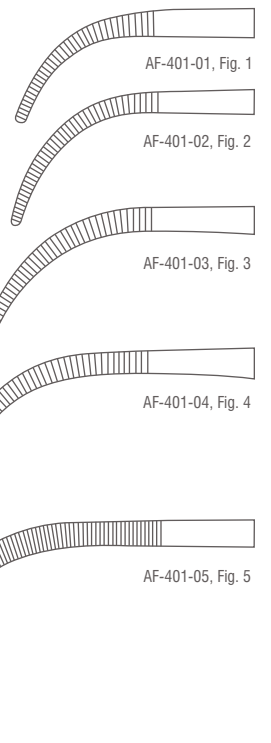
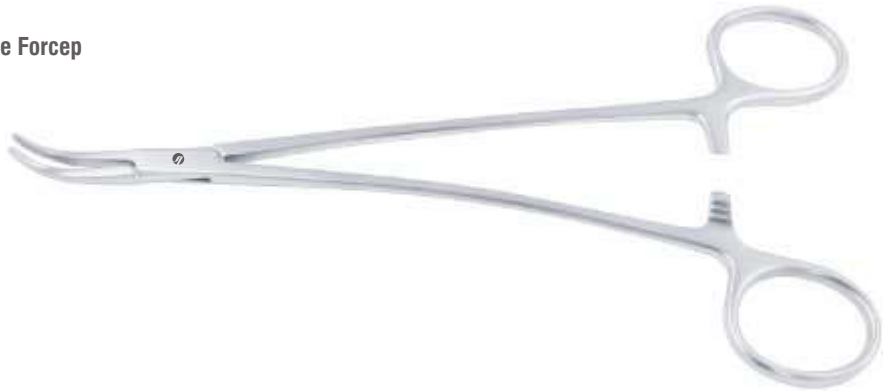

Catalog #	Size
AF-401-01	18.5 cm (7 1/4"), Fig. 1
AF-401-02	20.5 cm (8"), Fig. 2
AF-401-03	21 cm (8 1/4"), Fig. 3
AF-401-04	21.5 cm (8 1/2"), Fig. 4
AF-401-05	24.5 cm (9 3/4"), Fig. 5

Dissecting and Ligature Forcep
 Smooth Jaws



Catalog #	Size
AF-404-12	12.5 cm (5")

Dissecting and Ligature Forceps
 Präparierklemmen
 Pinzas para preparación y ligadura
 Pinces à disséquer et à ligatures
 Pinze per preparazioni e legature

Adson-Baby Dissecting and Ligature Forcep
 Curved

Catalog #	Size
AF-411-14	14.5 cm (5 ¾")
AF-411-18	18 cm (7")

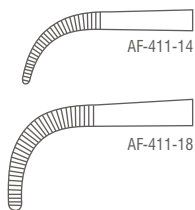

Overholt-Baby Dissecting and Ligature Forcep
 Curved

Catalog #	Size
AF-415-14	14 cm (5 ½")

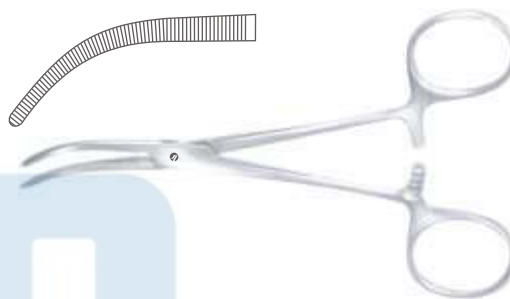
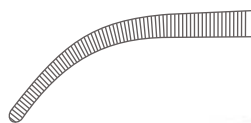

Overholt-Mixter Dissecting and Ligature Forcep
 Curved

Catalog #	Size
AF-417-21	21.5 cm (8 ½")

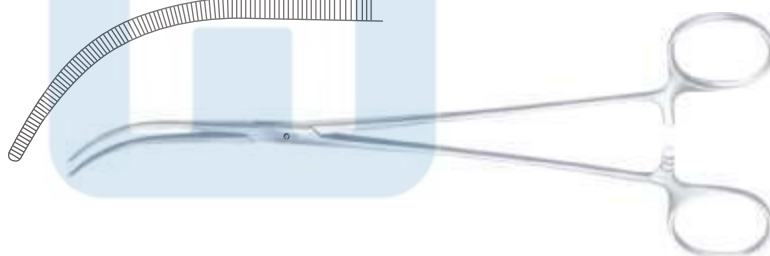
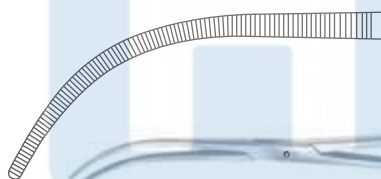

Dissecting and Ligature Forceps
 Präparierklemmen
 Pinzas para preparación y ligadura
 Pinces à disséquer et à ligatures
 Pinze per preparazioni e legature

Overholt-Geissendoerfer Dissecting and Ligature Forcep



Catalog #	Size
AF-421-01	20.5 cm (8"), Fig. 1
AF-421-02	20 cm (8"), Fig. 2
AF-421-03	21.5 cm (8 1/2"), Fig. 3
AF-421-04	22 cm (8 3/4"), Fig. 4
AF-421-05	21.5 cm (8 1/2"), Fig. 5
AF-421-06	22 cm (8 3/4"), Fig. 6
AF-421-07	22 cm (8 3/4"), Fig. 7

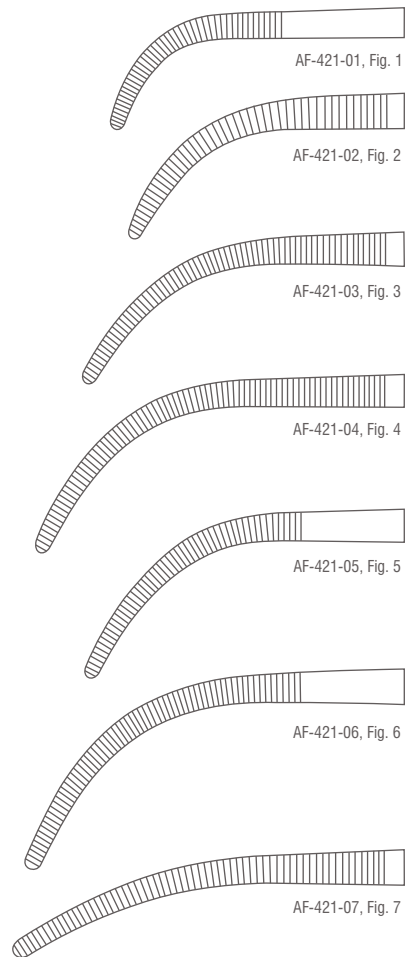
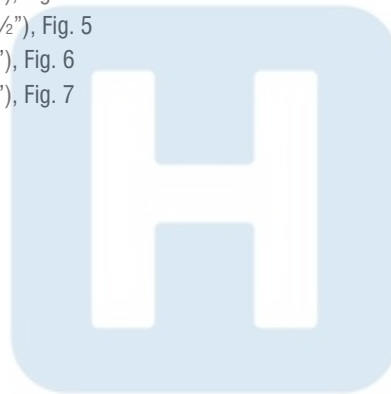

INCHES
MILLIMETERS

Dissecting and Ligature Forceps
 Präparierklemmen
 Pinzas para preparación y ligadura
 Pinces à disséquer et à ligatures
 Pinze per preparazioni e legature

Overholt-Geissendoerfer Dissecting and Ligature Forcep



Catalog #	Size
AF-423-01	27 cm (10 3/4"), Fig. 1
AF-423-02	26.5 cm (10 1/2"), Fig. 2
AF-423-03	27.5 cm (10 3/4"), Fig. 3
AF-423-04	28 cm (11"), Fig. 4
AF-423-05	27.5 cm (10 3/4"), Fig. 5
AF-423-06	28 cm (11"), Fig. 6
AF-423-07	27.5 cm (10 3/4"), Fig. 7

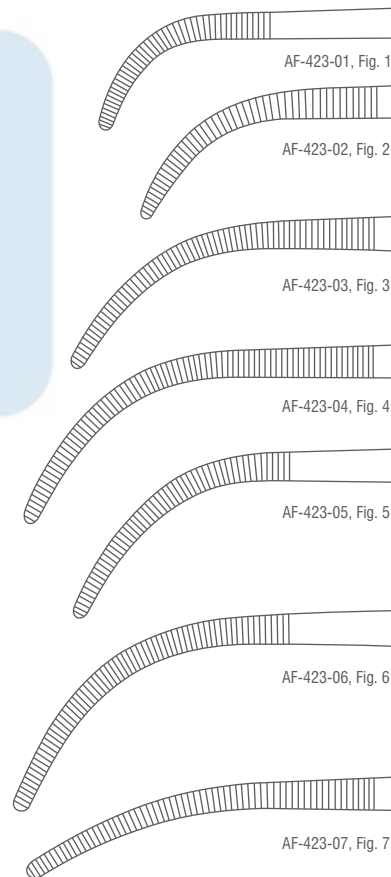

Dissecting and Ligature Forceps
 Präparierklemmen
 Pinzas para preparación y ligadura
 Pinces à disséquer et à ligatures
 Pinze per preparazioni e legature

**Overholt-Fine Dissecting and Ligature Forcep
 Curved**

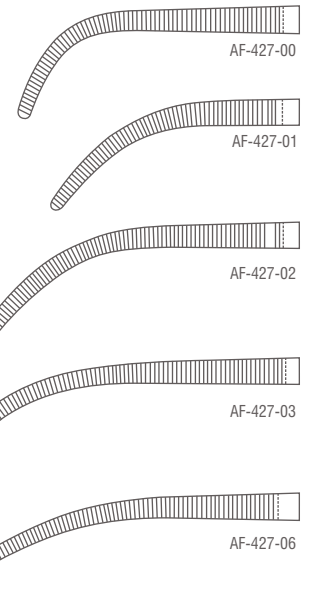

Catalog #	Size
AF-427-00	21.5 cm (8 1/2")
AF-427-01	21 cm (8 1/4")
AF-427-02	22 cm (8 3/4")
AF-427-03	23 cm (9")
AF-427-06	22.5 cm (8 3/4")

**Overholt Dissecting and Ligature Forcep
 Curved**

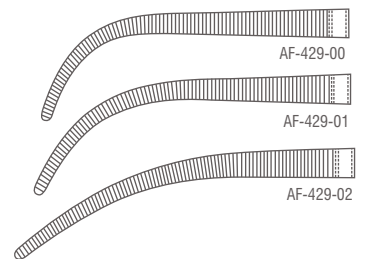

Catalog #	Size
AF-429-00	29.5 cm (11 1/2")
AF-429-01	29.5 cm (11 1/2")
AF-429-06	30 cm (11 3/4")

INCHES
 MILLIMETERS

Dissecting and Ligature Forceps
 Präparierklemmen
 Pinzas para preparación y ligadura
 Pinces à disséquer et à ligatures
 Pinze per preparazioni e legature

Overholt-Mini Dissecting and Ligature Forcep
 Curve, S Shaped

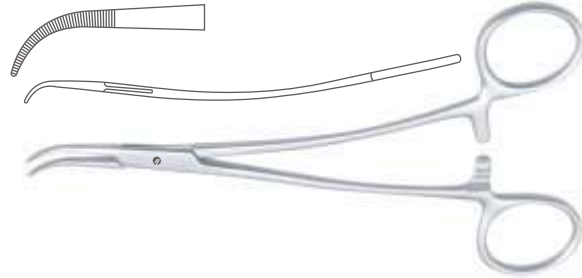

Catalog #	Size
AF-431-15	15 cm (6")

Overholt-Mini Dissecting and Ligature Forcep
 Curve



Catalog #	Size
AF-433-20	20 cm (8")

Kelly Dissecting and Ligature Forcep
 Fig. 1



Catalog #	Size
AF-441-19	19.5 cm (7 3/4")
AF-441-22	22.5 cm (8 3/4")
AF-441-24	24.5 cm (9 3/4")

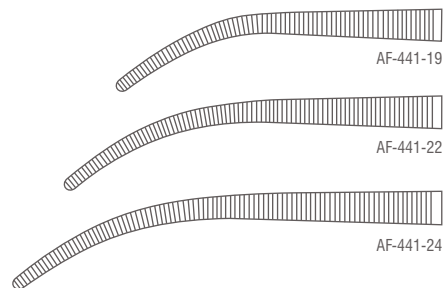

Dissecting and Ligature Forceps
 Präparierklemmen
 Pinzas para preparación y ligadura
 Pinces à disséquer et à ligatures
 Pinze per preparazioni e legature

Kelly Dissecting and Ligature Forcep
 Fig. 2



Catalog #	Size
AF-443-19	19 cm (7 1/2")
AF-443-22	22 cm (8 3/4")
AF-443-24	24 cm (9 1/2")

Kelly Dissecting and Ligature Forcep
 Fig. 3

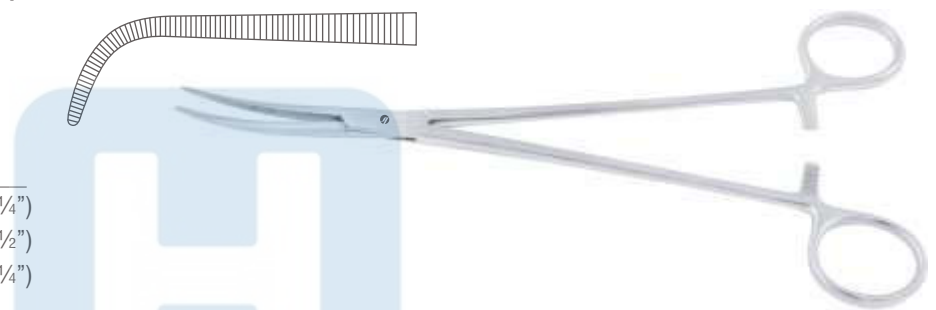

Catalog #	Size
AF-445-19	18.5 cm (7 1/4")
AF-445-22	21.5 cm (8 1/2")
AF-445-24	23.5 cm (9 1/4")

Lawrence Dissecting and Ligature Forcep
 Curved

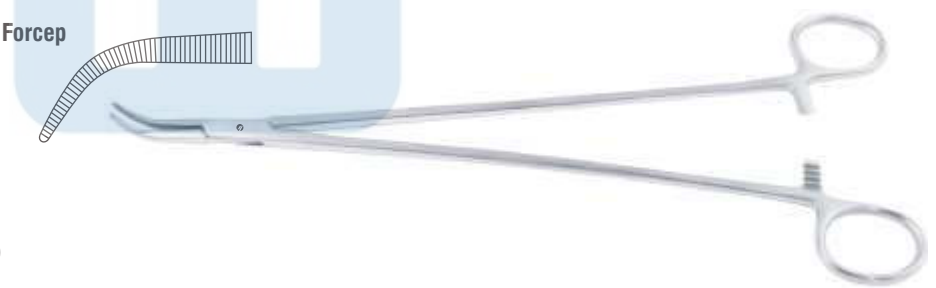

Catalog #	Size
AF-451-28	28 cm (11")

Meeker Dissecting and Ligature Forcep
 Right Angled



Catalog #	Size
AF-455-28	28 cm (11")

Dissecting and Ligature Forceps
 Präparierklemmen
 Pinzas para preparación y ligadura
 Pinces à disséquer et à ligatures
 Pinze per preparazioni e legature

Mini-Gemini Dissecting and Ligature Forcep
 Curved



Catalog #	Size
AF-469-18	18 cm (7")
AF-469-22	22.5cm (8 ¾")
AF-469-25	25 cm (9 ¾")
AF-469-28	28.5 cm (11 ¼")

Gemini Dissecting and Ligature Forcep
 Curved



Catalog #	Size
AF-471-13	13 cm (5")
AF-471-16	16 cm (6 ¼")
AF-471-18	18 cm (7")
AF-471-20	21 cm (8 ¼")
AF-471-23	23 cm (9")
AF-471-25	25 cm (9 ¾")
AF-471-28	28 cm (11")

Rumel Dissecting and Ligature Forcep
 Curved



Catalog #	Size
AF-475-01	24 cm (9 ½")
AF-475-02	23.5 cm (9 ½")
AF-475-03	23 cm (9")
AF-475-04	24 cm (9 ½")
AF-475-05	23.5 cm (9 ¼")

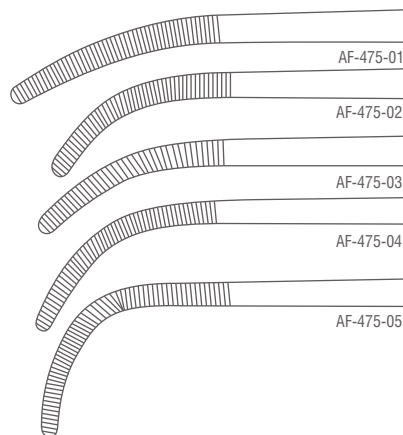

Dissecting and Ligature Forceps
 Präparierklemmen
 Pinzas para preparación y ligadura
 Pinces à disséquer et à ligatures
 Pinze per preparazioni e legature

Zenker Dissecting and Ligature Forcep Curved

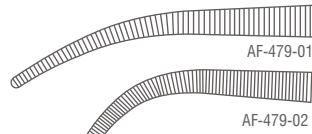

Catalog #	Size
AF-479-01	29.5 cm (11 1/2")
AF-479-02	28.5 cm (11 1/4")



Kieback Dissecting and Ligature Forcep Curved



Catalog #	Size
AF-481-23	23.5 cm (9 1/4")



Mixer-Baby Dissecting and Ligature Forcep Gently Curved



Catalog #	Size
AF-491-01	13.5 cm (5 1/4")



Mixer-Baby Dissecting and Ligature Forcep Strongly Curved

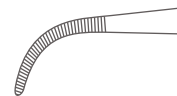

Catalog #	Size
AF-491-02	13 cm (5")



Mixer-Baby Dissecting and Ligature Forcep Curved

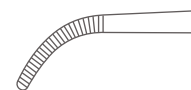

Catalog #	Size
AF-493-14	13.5 cm (5 1/4")



Dissecting and Ligature Forceps
 Präparierklemmen
 Pinzas para preparación y ligadura
 Pinces à disséquer et à ligatures
 Pinze per preparazioni e legature

Mixer-Baby Dissecting and Ligature Forcep
 Curved



Catalog #	Size
AF-495-18	18.5 cm (7 1/4")

Mixer Dissecting and Ligature Forcep
 Right Angled



Catalog #	Size
AF-497-15	16 cm (6 1/4")
AF-497-19	18 cm (7")

Mixer Dissecting and Ligature Forcep
 Curved

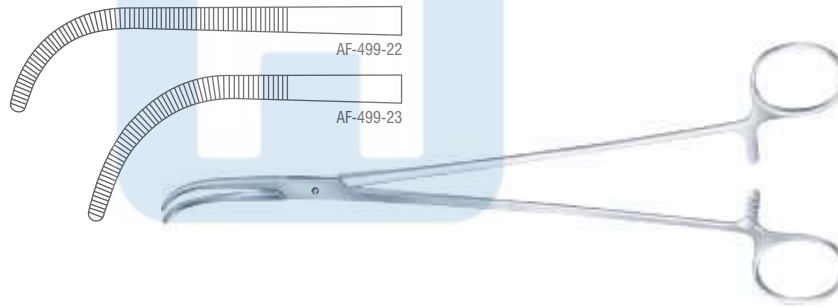

Catalog #	Size
AF-499-22	22.5 cm (8 3/4")
AF-499-23	23 cm (9")

Mixer Dissecting and Ligature Forcep
 Right Angled, Longitudinally Serrated



Catalog #	Size
AF-501-22	22.5 cm (8 3/4")
AF-501-25	26 cm (10 1/4")
AF-501-28	28 cm (11")

Dissecting and Ligature Forceps
 Präparierklemmen
 Pinzas para preparación y ligadura
 Pinces à disséquer et à ligatures
 Pinze per preparazioni e legature

McQuigg-Mixter Dissecting and Ligature Forcep
 Right Angled, Longitudinally Serrated

Catalog #	Size
AF-505-22	23.5 cm (9 1/4")



Mixter-O'Shaughnessy Dissecting and Ligature Forcep
 Curved

Catalog #	Size
AF-509-19	18.5 cm (7")



O'Shaughnessy Dissecting and Ligature Forcep
 Curved

Catalog #	Size
AF-511-14	15 cm (6")
AF-511-17	18 cm (7")
AF-511-20	20 cm (8")
AF-511-23	23 cm (9")
AF-511-26	26 cm (10 1/4")

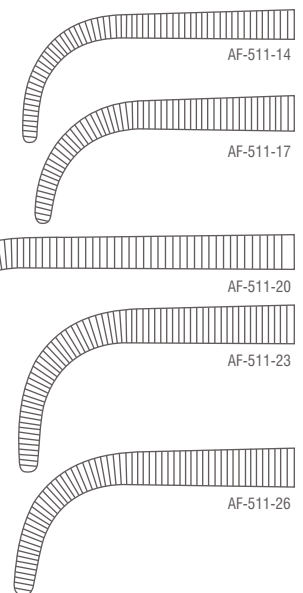
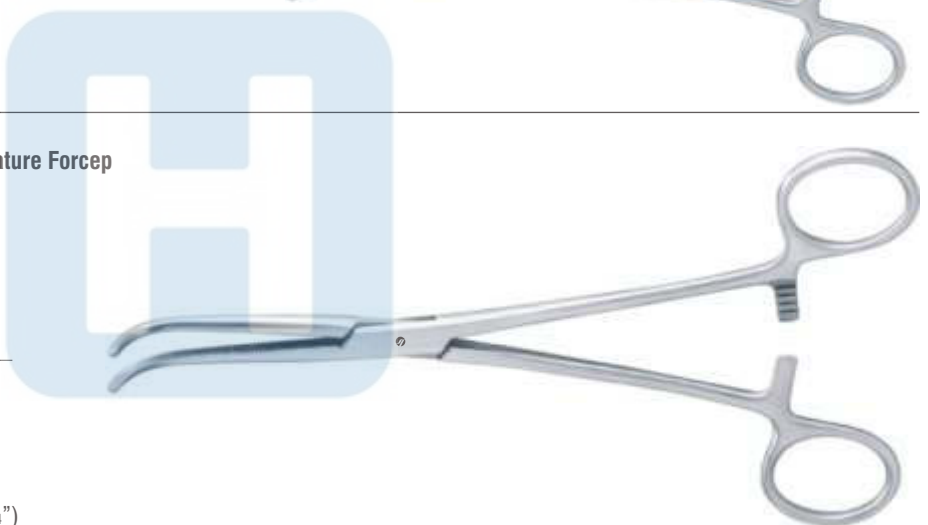

Dissecting and Ligature Forceps
 Präparierklemmen
 Pinzas para preparación y ligadura
 Pinces à disséquer et à ligatures
 Pinze per preparazioni e legature

Wickstroem Dissecting and Ligature Forcep
 Right Angled



Catalog #	Size
AF-517-21	21 cm (8 ¼")
AF-517-24	24.5 cm (9 ¾")

Lahey Dissecting and Ligature Forcep
 Curved



Catalog #	Size
AF-519-18	18.5 cm (7 ¼")

Kantrowitz Dissecting and Ligature Forcep
 Right Angled

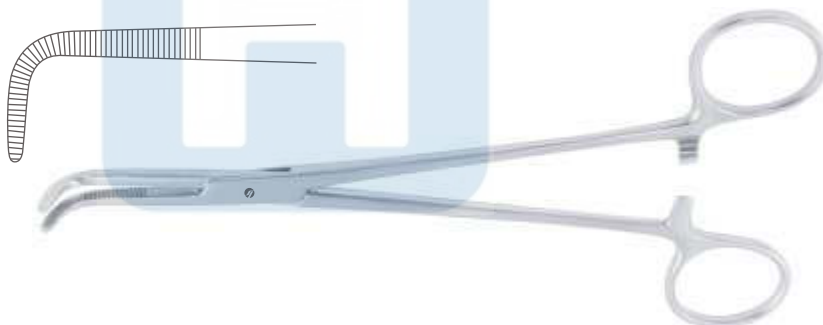

Catalog #	Size
AF-523-20	20 cm (8")
AF-523-25	25 cm (9 ¾")
AF-523-27	27.5 cm (10 ¾")

Barre Dissecting and Ligature Forcep
 Extra Delicate

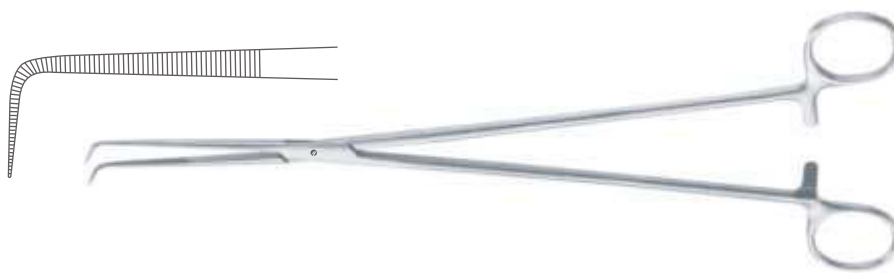

Catalog #	Size
AF-527-28	28 cm (11")

Barre Dissecting and Ligature Forcep
 Delicate



Catalog #	Size
AF-529-28	28 cm (11")

Bile Duct Clamps, Dissecting and Ligature Forceps
 Gallenkanalklemmen, Präparierklemmen
 Pinzas para conducto biliar, Pinzas para preparación y ligadura
 Pinces pour les voies biliaires, Pinces à disséquer et à ligatures
 Pinze per vie biliari, Pinze per preparazioni e legature

Lahey (Sweet) Bile Duct Clamp
 Curved



Catalog #	Size
AF-535-19	19.5 cm (7 3/4")

Lahey Bile Duct Clamp
 Angled

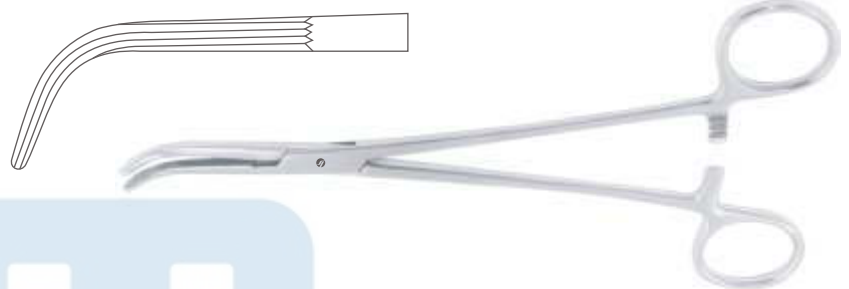

Catalog #	Size
AF-537-23	22.5 cm (8 3/4")

Lahey (Sweet) Bile Duct Clamp
 Curved

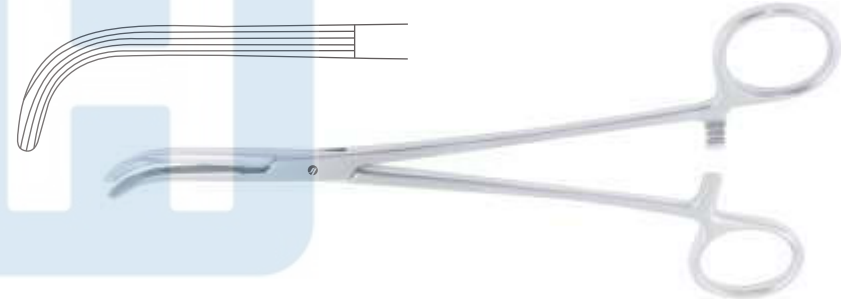

Catalog #	Size
AF-539-23	23 cm (9")

Finochietto Dissecting and Ligature Forcep
 Right Angled

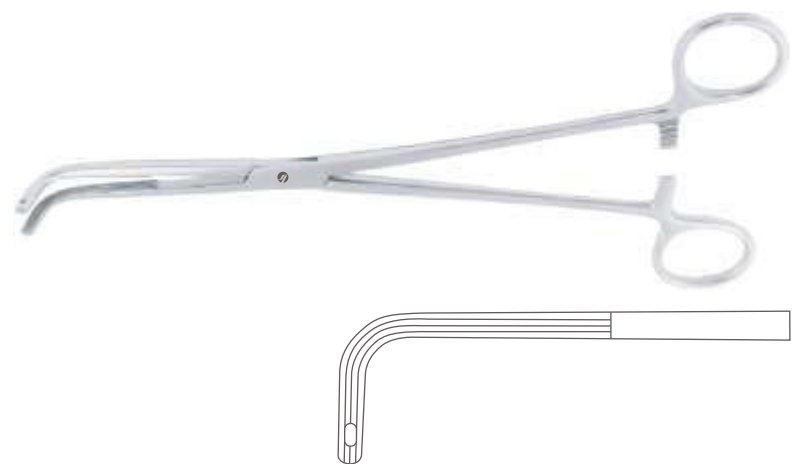

Catalog #	Size
AF-541-24	24 cm (9 1/2")

Tangential Forceps, Kidney Pedicle Clamps
 Tangentialklemmen, Nierenstielklemmen
 Pinzas tangenciales, Pinzas para pedículo renal
 Pinces tangentielles, Pince-clamps pour pédicules rénaux
 Pinze tangenziali, Pinze per peduncoli renali

Uro-Tangential Atrauma Tangential Forcep

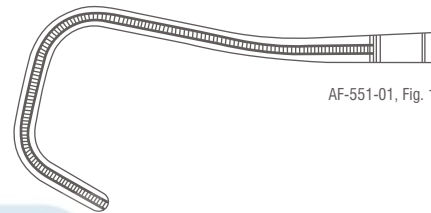
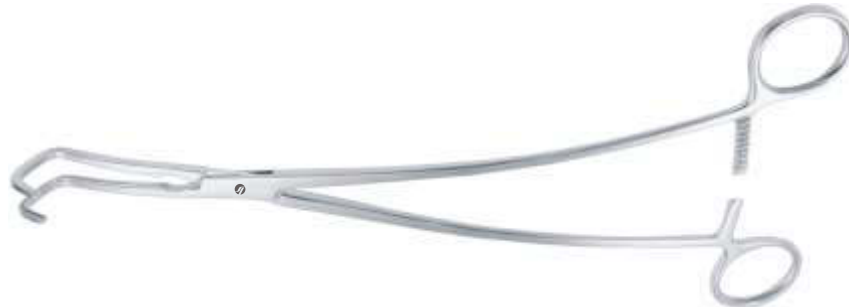

AF-551-01, Fig. 1

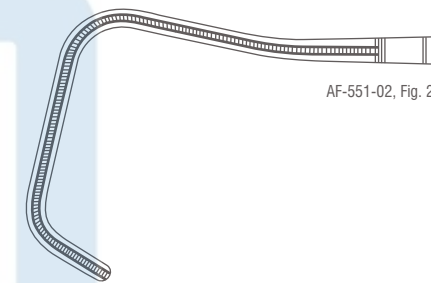

AF-551-02, Fig. 2

Catalog #	Size, Profile
AF-551-01	25 cm (9 3/4"), Fig. 1
AF-551-02	27 cm (10 3/4"), Fig. 2

Guyon Atrauma Kidney Pedicle Clamp Curved

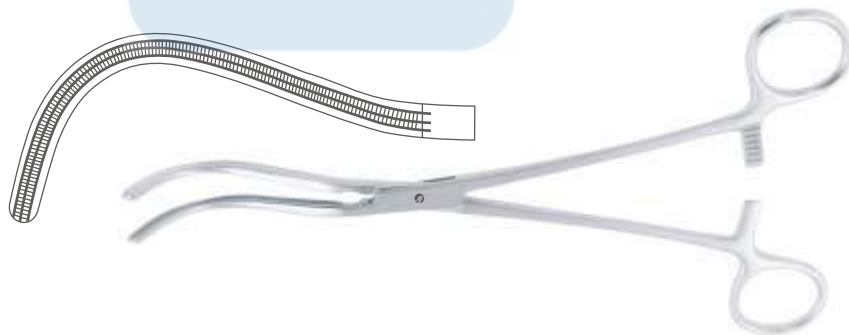

Catalog #	Size
AF-561-23	23 cm (9")
AF-561-24	24 cm (9 1/2")

Guyon Kidney Pedicle Clamp Curved

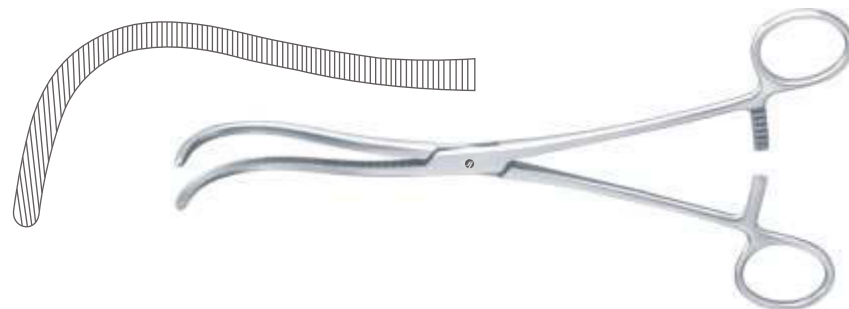

Catalog #	Size
AF-563-23	24 cm (9 1/2")

Kidney Pedicle Clamps, Bile Duct Clamps
 Nierenstielklemmen, Gallenkanalklemmen
 Pinzas para pedículo renal, Pinzas para conducto biliar
 Pince-clamps pour pédicules rénaux, Pincas pour les voies biliaires
 Pinze per peduncoli renali, Pinze per vie biliari

Guyon Kidney Pedicle Clamp
 Curved

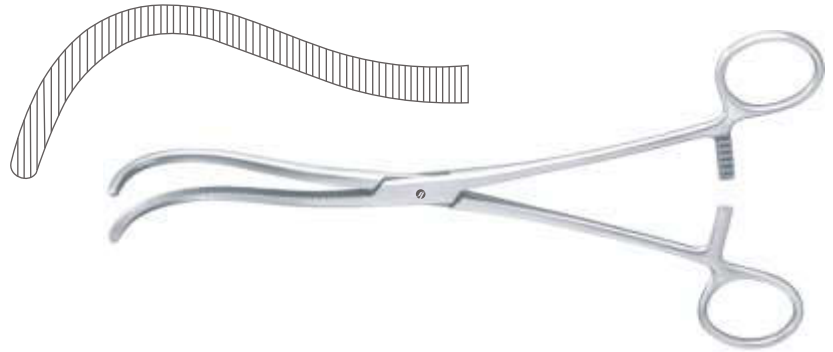

Catalog #	Size
AF-565-20	19.5 cm (7 3/4")
AF-565-22	21.5 cm (8 1/2")
AF-565-24	24 cm (9 1/2")

Stille Kidney Pedicle Clamp
 Curved, Grooved

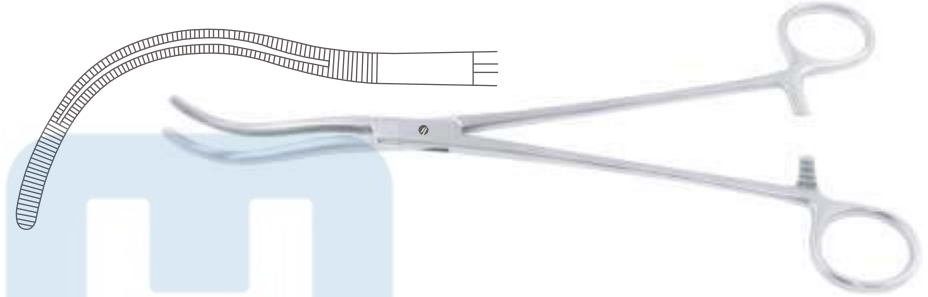

Catalog #	Size
AF-569-23	23 cm (9")

Herrick Kidney Pedicle Clamp
 Double Angled, Longitudinally Serrated

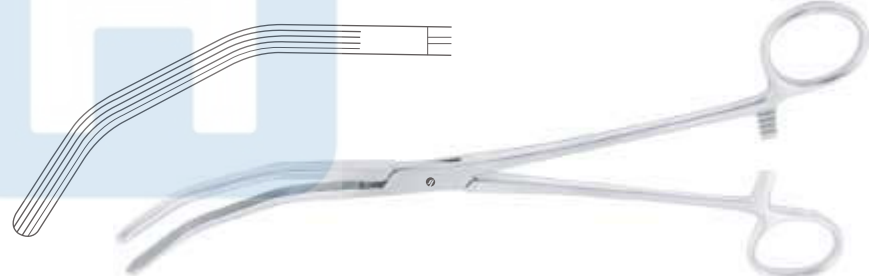

Catalog #	Size
AF-571-23	23 cm (9")

Desjardins Bile Duct Clamp
 Curved Downwards



Catalog #	Size
AF-581-21	21 cm (8 1/4")

Nissen Bile Duct Clamp
 Curved Downwards



Catalog #	Size
AF-583-21	21.5 cm (8 1/2")

Dissecting and Ligature Forceps, Hysterectomy Forceps
 Präparierklemmen, Hysterektomieklemmen
 Pinzas para preparación y ligadura, Pinzas para histerectomía
 Pincès à disséquer et à ligatures, Pincès à hystérectomie
 Pinze per preparazioni e legature, Pinze per isterectomia

Gray Dissecting and Ligature Forcep
 Curved S Shaped

Catalog #	Size
AF-591-01	22 cm (8 ¾")
AF-591-02	22 cm (8 ¾")



Phaneuf Hysterectomy Forcep
 Straight, 1 x 2 Teeth

Catalog #	Size
AF-594-21	20.5 cm (8")

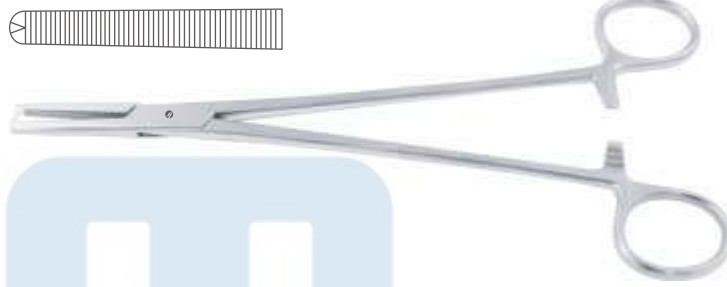

Phaneuf Hysterectomy Forcep
 Curved, 1 x 2 Teeth

Catalog #	Size
AF-595-21	20 cm (8")

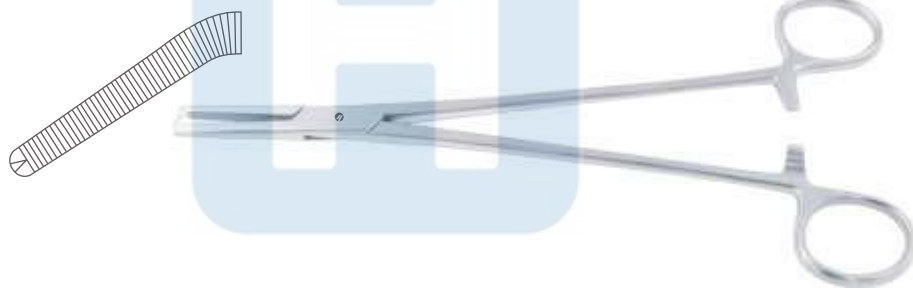

Maingot Hysterectomy Forcep
 Curved, 1 x 2 Teeth

Catalog #	Size
AF-597-20	20.5 cm (8")
AF-597-25	25 cm (9 ¾")



Maingot Hysterectomy Forcep
 Straight, 1 x 2 Teeth

Catalog #	Size
AF-598-20	20 cm (8")

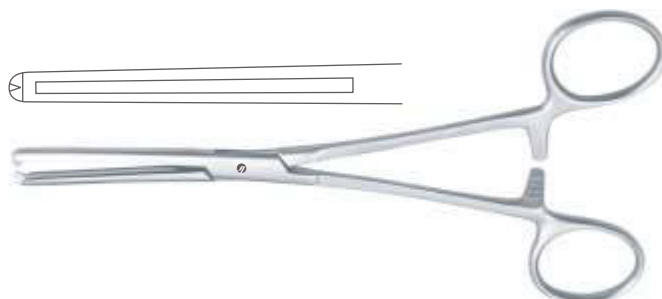

Hysterectomy Forceps
 Hysterektomieklappen
 Pinzas para histerectomia
 Pinces à hystérectomie
 Pinze per isterectomia

**Heaney-Ballentine Hysterectomy Forcep
 Straight**

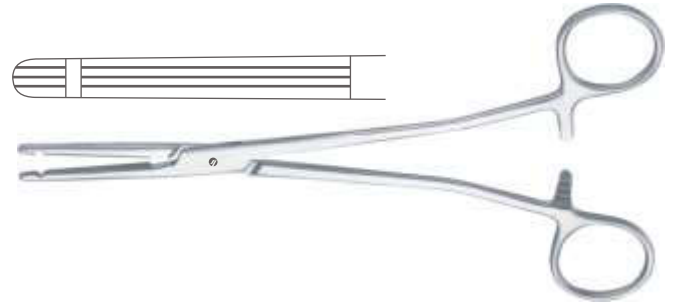

Catalog #	Size
AF-600-21	21.5 cm (8 1/2")

**Heaney-Ballentine Hysterectomy Forcep
 Curved**

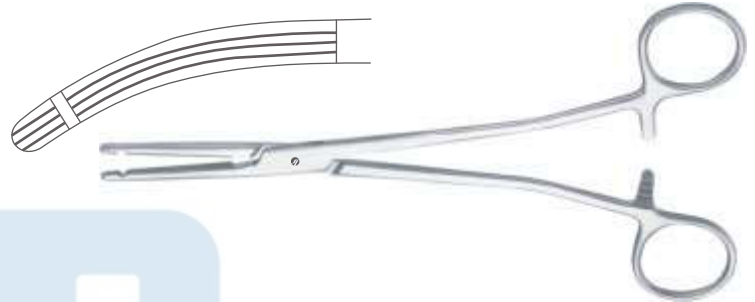

Catalog #	Size
AF-601-21	21.5 cm (8 1/2")

**Heaney-Razek Hysterectomy Forcep
 Straight**

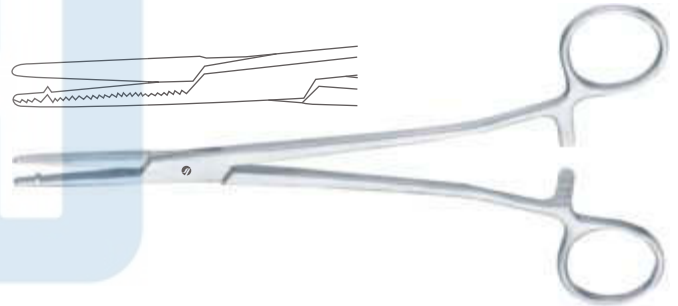

Catalog #	Size
AF-604-21	21 cm (8 1/4")

**Heaney Hysterectomy Forcep
 Curved, 1 Tooth**



Catalog #	Size
AF-607-19	19.5 cm (7 3/4")
AF-607-21	21.5 cm (8 1/2")
AF-607-23	24 cm (9 1/2")

Hysterectomy Forceps
 Hysterektomieklemmen
 Pinzas para histerectomia
 Pinces à hystérectomie
 Pinze per isterectomia

Heaney Hysterectomy Forcep
 Curved, 2 Tooth



Catalog #	Size
AF-609-19	19.5 cm (7 ¾")
AF-609-21	21.5 cm (8 ½")
AF-609-23	24 cm (9 ½")

Dick Atrauma Vaginal Clamp
 Angled

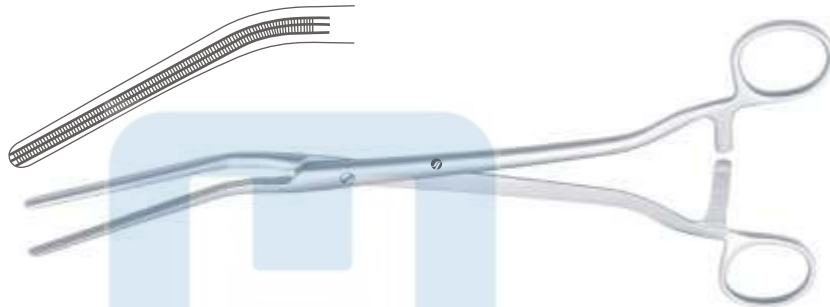

Catalog #	Size
AF-621-25	25.5 cm (10")
AF-621-26	26.5 cm (10 ½")
AF-621-27	27.5 cm (10 ¾")

Wertheim Atrauma Vaginal Clamp
 Right Angled

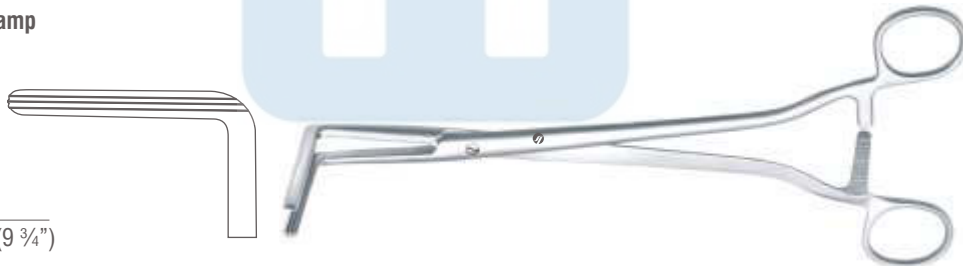

Catalog #	Size
AF-625-25	25 cm (9 ¾")

Wertheim-Cullen Vaginal Clamp



Catalog #	Size
AF-629-21	21 cm (8 ¼")

Hysterectomy Forceps
 Hysterektomieklemmen
 Pinzas para histerectomía
 Pinças à hysterectomie
 Pinze per isterectomia

Heaney (Rogers) Hysterectomy Forcep



AF-635-10, Fig. 1



AF-635-20, Fig. 2

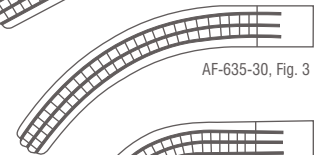

AF-635-30, Fig. 3

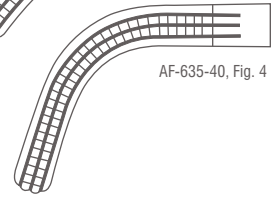

AF-635-40, Fig. 4

Catalog #	Size
AF-635-10	21.5 cm (8 1/2"), Fig. 1
AF-635-20	21 cm (8 1/4"), Fig. 2
AF-635-30	20.5 cm (8"), Fig. 3
AF-635-40	20 cm (8"), Fig. 4

Wertheim (Rogers) Hysterectomy Forcep



AF-637-10, Fig. 1

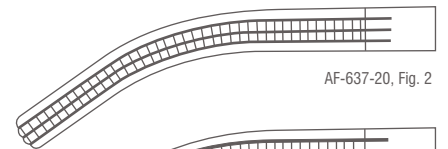

AF-637-20, Fig. 2

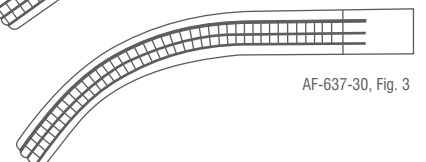

AF-637-30, Fig. 3

Catalog #	Size
AF-637-10	25.5 cm (10"), Fig. 1
AF-637-20	25 cm (9 3/4"), Fig. 2
AF-637-30	24.5 cm (9 3/4"), Fig. 3

Hysterectomy Forceps
 Hysterektomieklemmen
 Pinzas para histerectomía
 Pinces à hystérectomie
 Pinze per isterectomia

Wertheim Hysterectomy Forcep
 Angled

Catalog #	Size
AF-639-22	22 cm (8 ¾")



Segond-Landau Hysterectomy Forcep
 Straight

Catalog #	Size
AF-642-24	24 cm (9 ½")



Segond Hysterectomy Forcep
 Curved

Catalog #	Size
AF-643-24	24 cm (9 ½")



Holzbach Hysterectomy Forcep
 Straight

Catalog #	Size
AF-646-24	24.5 cm (9 ¾")



Holzbach Hysterectomy Forcep
 Curved

Catalog #	Size
AF-647-24	24.5 cm (9 ¾")



Hysterectomy Forceps
 Hysterektomieklemmen
 Pinzas para histerectomía
 Pinces à hystérectomie
 Pinze per isterectomia

Gwilliam Hysterectomy Forcep
 Straight

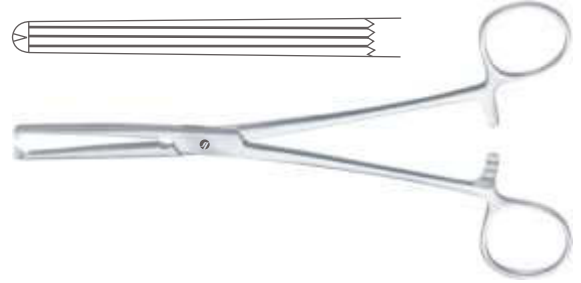

Catalog #	Size
AF-648-20	20 cm (8")

Gwilliam Hysterectomy Forcep
 Curved

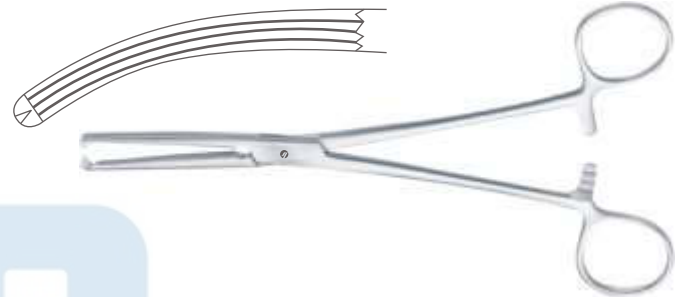

Catalog #	Size
AF-649-20	20 cm (8")

Berkeley-Bonney Hysterectomy Forcep
 Curved

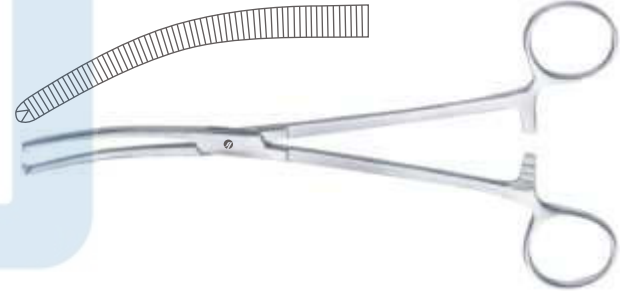

Catalog #	Size
AF-651-20	20 cm (8")

Kieback Hysterectomy Forcep
 Straight

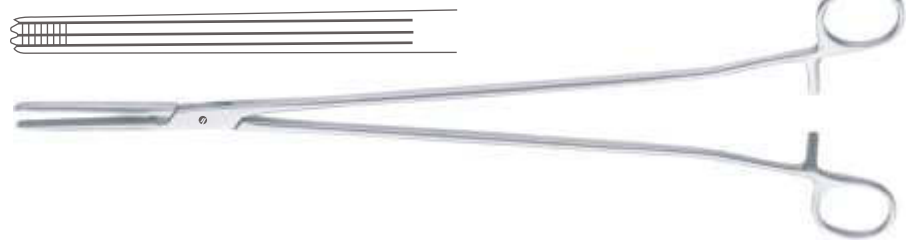

Catalog #	Size
AF-654-25	25 cm (9 3/4")

Kieback Hysterectomy Forcep
 Curved

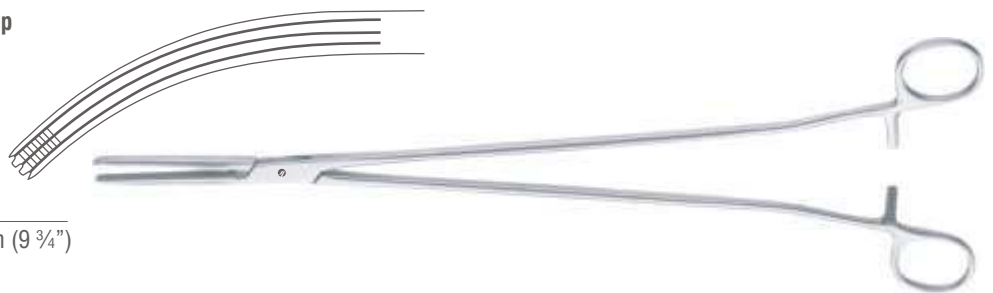

Catalog #	Size
AF-655-25	25 cm (9 3/4")

INCHES
 MILLIMETERS

Hysterectomy Forceps
 Hysterektomieklemmen
 Pinzas para histerectomía
 Pincers à hystérectomie
 Pinze per isterectomia

Burke Hysterectomy Forcep
 Curved, Short Jaws

Catalog #	Size
AF-657-25	25 cm (9 ¾")



Burke Hysterectomy Forcep
 Curved, Long Jaws

Catalog #	Size
AF-659-25	25 cm (9 ¾")



Moynihan Hysterectomy Forcep
 Curved

Catalog #	Size
AF-661-23	23 cm (9")

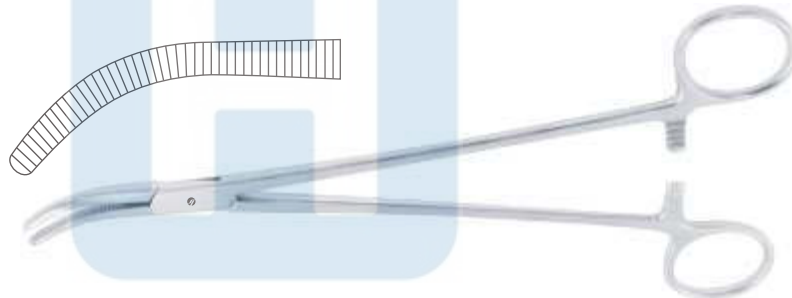

Moynihan Hysterectomy Forcep
 Curved

Catalog #	Size
AF-663-24	23.5 cm (9 ¼")



Wertheim Hysterectomy Forcep
 Curved

Catalog #	Size
AF-667-25	26 cm (10 ¼")



Hysterectomy Forceps, Peritoneum Forceps
 Hysterektomieklemmen, Peritoneumklemmen
 Pinzas para histerectomía, Pinzas para peritoneo
 Pinces à hystérectomie, Pince pour le péritoine
 Pinze per isterectomia, Pinze per peritoneo

Wertheim Hysterectomy Forcep
 Curved , 1 x 2 Teeth



Catalog #	Size
AF-669-22	22.5 cm (8 ¾")

Wertheim Hysterectomy Forcep
 Curved , 1 x 2 Teeth

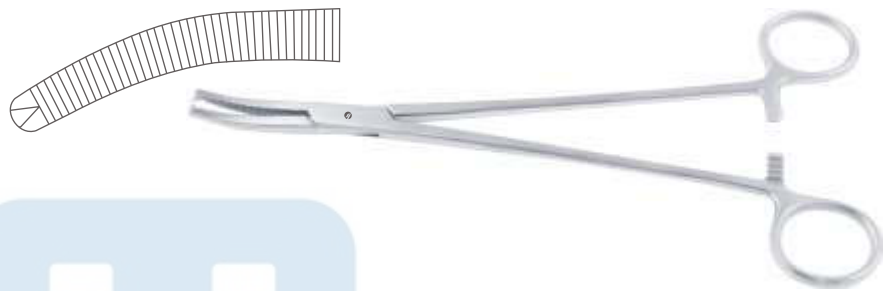

Catalog #	Size
AF-671-23	22.5 cm (8 ¾")

Fergusson Angiotribe
 Straight

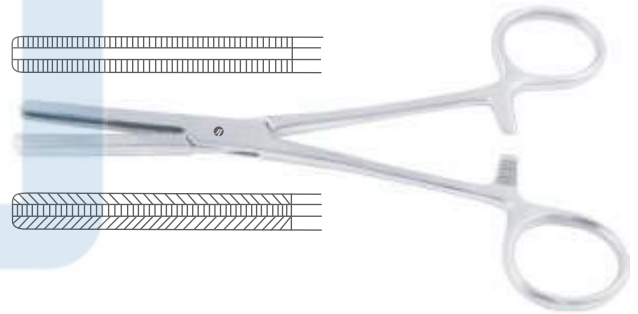

Catalog #	Size
AF-680-16	16 cm (6 ¼")
AF-680-20	20 cm (8")

Fergusson Angiotribe
 Curved

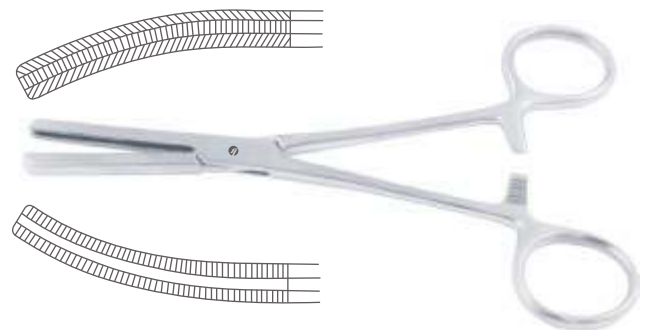

Catalog #	Size
AF-681-16	16 cm (6 ¼")
AF-681-20	20 cm (8")

Mikulicz-Baby Peritoneum Forcep
 Curved, 1 x 2 Teeth

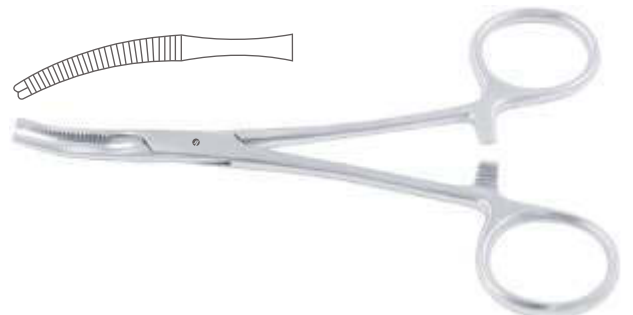

Catalog #	Size
AF-685-14	14 cm (5 ¾")

Peritoneum Forceps
 Peritoneumklemmen
 Pinzas para peritoneo
 Pince pour le péritoine
 Pinze per peritoneo

Mikulicz Peritoneum Forcep
 Curved, 1 x 2 Teeth

Catalog #	Size
AF-687-18	18.5 cm (7 1/4")



Mikulicz Peritoneum Forcep
 Curved, 1 x 2 Teeth

Catalog #	Size
AF-689-20	20 cm (8")



Mikulicz Peritoneum Forcep
 Curved, 1 x 2 Teeth

Catalog #	Size
AF-691-20	20 cm (8")

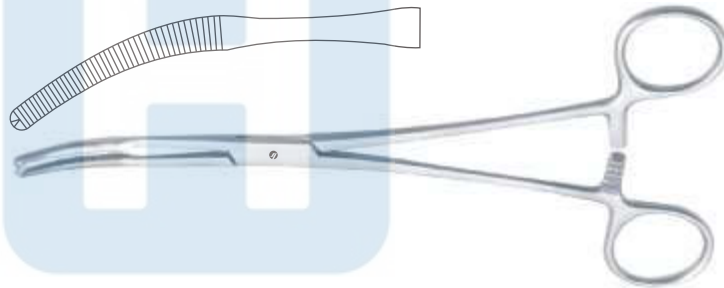

Mikulicz Peritoneum Forcep
 Curved, Longitudinal Serrations, 1 x 2 Teeth

Catalog #	Size
AF-693-24	24.5 cm (9 3/4")



Mikulicz Peritoneum Forcep
 Curved, 1 x 2 Teeth

Catalog #	Size
AF-695-21	20.5 cm (8")

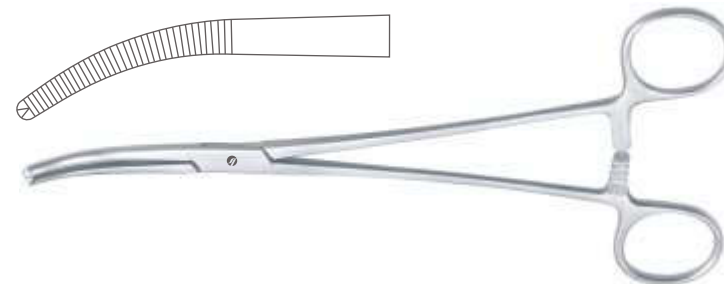

Peritoneum Forceps, Towel Clamps
 Peritoneumklemmen, Tuchklemmen
 Pinzas para peritoneo, Pinzas de campo
 Pince pour le péritoine, Pince à champs
 Pinze per peritoneo, Pinze fissatele

Faure Peritoneum Forcep
 Curved , 1 x 2 Teeth



Catalog #	Size
AF-697-20	21 cm (8 ¼")

Faure Peritoneum Forcep
 Curved , 1 x 2 Teeth



Catalog #	Size
AF-699-20	21 cm (8 ¼")

Doyen Towel Clamp

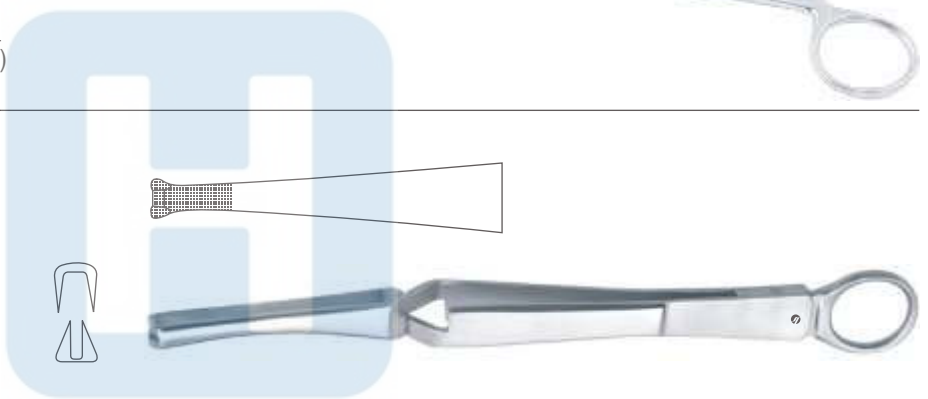

Catalog #	Size
AF-751-18	18 cm (7")

Schaedel Towel Clamp
 Sharp



Catalog #	Size
AF-755-09	9 cm (3 ½")

Jones Towel Clamp
 Sharp



Catalog #	Size
AF-761-05	5.5 cm (2 ½")
AF-761-09	8.5 cm (3 ¼")

Towel Clamps
Tuchklemmen
Pinzas de campo
Pinces à champs
Pinze fissatele

Martin-Jones Towel Clamp
Sharp, With Cable Holder



Catalog #	Size
AF-765-09	8.5 cm (3 1/4")

Robin Towel Clamp
With Cable Holder

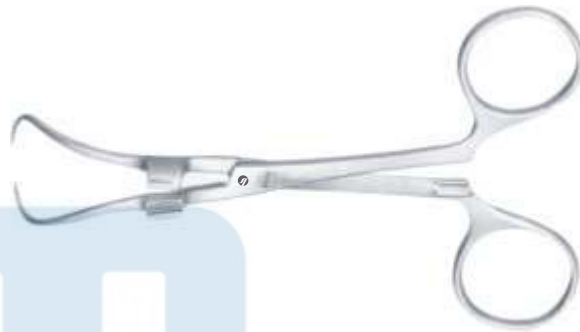

Catalog #	Size, Usage
AF-769-01	13.5 cm (5 1/4"), For Cable Up To 5 mm
AF-769-02	13.5 cm (5 1/4"), For Cable Up To 13 mm

Backhaus Towel Clamp
With Tube Holder

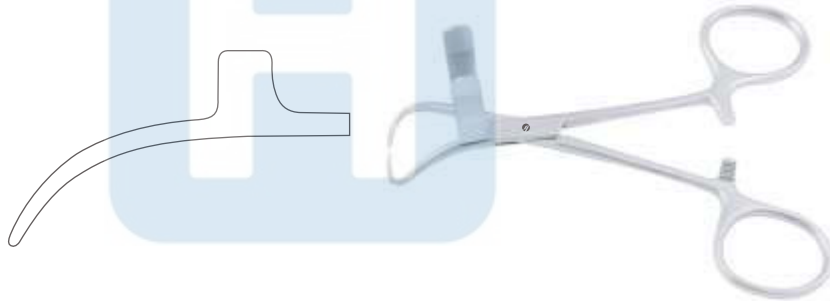

Catalog #	Size
AF-771-11	13 cm (5")

Backhaus Towel Clamp



Catalog #	Size
AF-773-08	9 cm (3 1/2")
AF-773-11	11.5 cm (4 1/2")
AF-773-13	13 cm (5")
AF-773-15	16 cm (6 1/4")

Towel Clamps
 Tuchklemmen
 Pinzas de campo
 Pinces à champs
 Pinze fissatele

Roeder Towel Clamp



Catalog #	Size
AF-777-13	13.5 cm (5 1/4")

Lorna Towel Clamp
 Fine Serrated, Wide Jaw

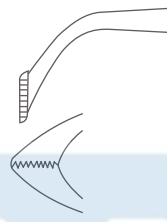

Catalog #	Size
AF-781-10	9.5 cm (3 3/4")
AF-781-13	13 cm (5")

Bernhard Towel Clamp



Catalog #	Size
AF-785-16	16.5 cm (6 1/2")

Tohoku Towel Clamp
 Blunt

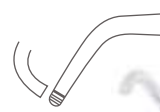

Catalog #	Size
AF-787-10	10.5 cm (4")
AF-787-13	13.5 cm (5 1/4")

Non Perforating Towel Clamp

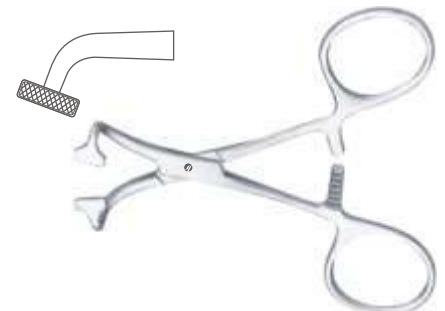

Catalog #	Size
AF-791-10	10 cm (4")
AF-791-13	13.5 cm (5 1/4")

Towel Clamps, Tubing Clamps
 Tuchklemmen, Schlauchklemmen
 Pinzas de campo, Pinzas para tubos
 Pincas à champs, Pincas presse-tubes
 Pinze fissatele, Pinze serratubi

Peers-Bretram Towel Clamp

With Jaw for Tube Fixation

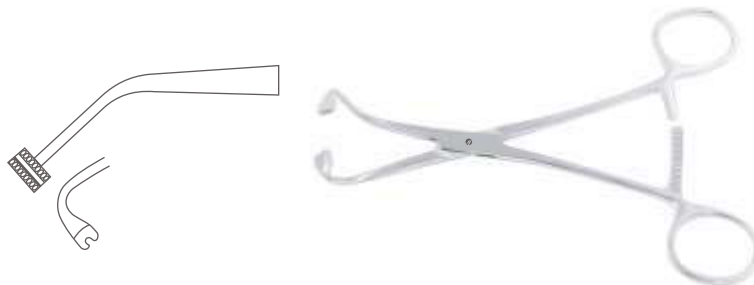

Catalog #	Size
AF-793-14	14.5 cm (5 ¾")

Towel Clamp

For Paper Clothes



Catalog #	Size
AF-795-11	11.5 cm (4 ½")
AF-795-14	14 cm (5 ½")

Lane Towel Clamp

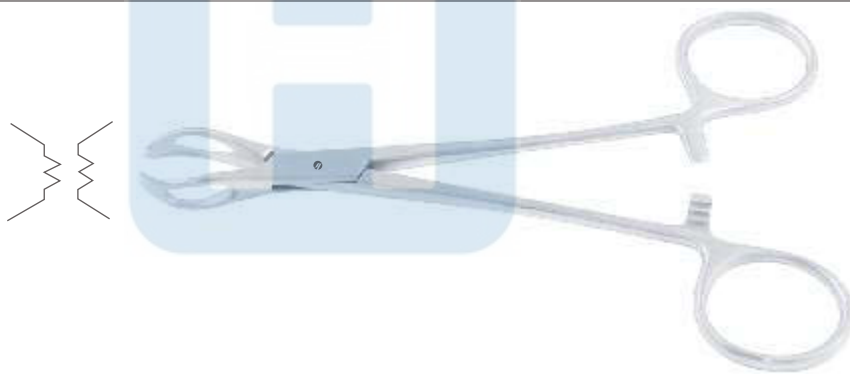

Catalog #	Size
AF-799-13	13 cm (5")
AF-799-15	15.5 cm (6")
AF-799-20	19.5 cm (7 ¾")

Klinikum Berlin Tubing Clamp

Extra Long Ratchet



Catalog #	Size
AF-850-14	14 cm (5 ½")

Tubing Clamps
Schlauchklemmen
Pinzas para tubos
Pinces presse-tubes
Pinze serratubi

Presbyterian Tubing Clamp

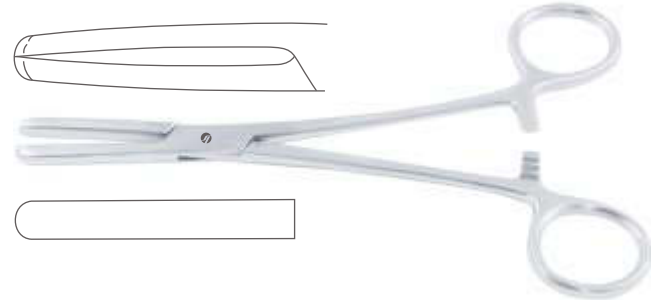

Catalog #	Size
AF-852-16	16.5 cm (6 1/2")
AF-852-18	18 cm (7")

Tubing Clamp



Catalog #	Size
AF-860-15	15.5 cm (6")
AF-860-18	19 cm (7 1/2")
AF-860-20	20.5 cm (8")

**Tubing Clamp
With Safety Guard**



Catalog #	Size
AF-862-15	15.5 cm (6")
AF-862-18	19 cm (7 1/2")
AF-862-20	20.5 cm (8")

Brompton Tube Milking Roller



Catalog #	Size
AF-890-00	Standard

Tubing Clamps
Schlauchklemmen
Pinzas para tubos
Pinces presse-tubes
Pinze serratubi

Hoffmann Tubing Clamp

Catalog #	Width
AF-950-13	13 mm
AF-950-17	17 mm
AF-950-20	20 mm
AF-950-25	25 mm
AF-950-30	30 mm
AF-950-40	40 mm



Mohr Pinchcocks

Catalog #	Width
AF-953-40	40 mm
AF-953-50	50 mm
AF-953-60	60 mm
AF-953-70	70 mm
AF-953-80	80 mm



HOSPITA®

ALWAYS THE BEST

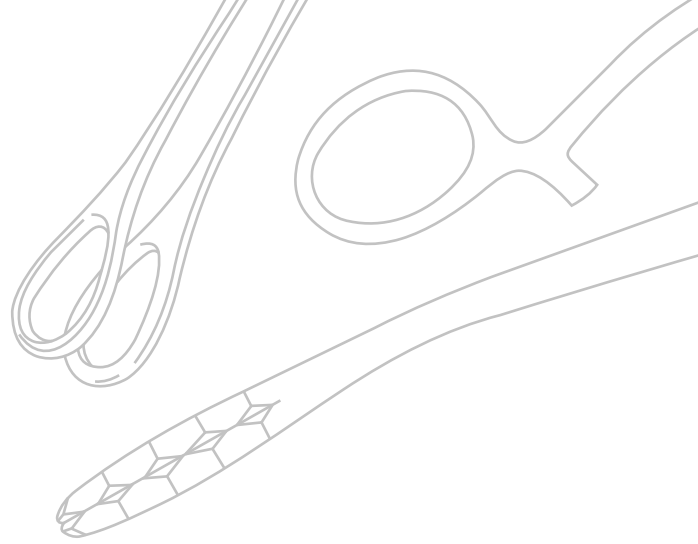

SF



COTTON SWAB AND DRESSING FORCEPS

Hospita sponge forceps are the perfect choice for holding swabs or sponges in medical procedures. Our range is manufactured in box-joint scissor action with ratcheted handles and looped, smooth or serrated jaws, curved or straight to meet your specific purpose. Many surgeons prefer to use Surtex sponge forceps because they help prevent trauma during surgery by enabling the physician to hold and move tissue very precisely and gently



Tupfer und Kornzangen

Pizas para tapones y -curaciones

Pinces à tampons et à pansements

Pinze per tamponi e per medicazione

Dressing Forceps
 Tupferzangen
 Pinzas para tapones
 Pinces à tampons
 Pinze per tamponi

Ulrich Dressing Forcep
 Straight

Catalog #	Size
SF-100-22	22.5 cm (8 ¾")
SF-100-27	26.5 cm (10 ½")



Ulrich Dressing Forcep
 Curved

Catalog #	Size
SF-101-22	22.5 cm (8 ¾")
SF-101-27	26.5 cm (10 ½")



Bryant Dressing Forcep
 Curved

Catalog #	Size
SF-111-13	13 cm (5")



Lister Sinus Forcep
 Straight

Catalog #	Size
SF-120-13	13 cm (5")
SF-120-16	16 cm (6 ¼")
SF-120-18	17 cm (7")



Martin Dressing Forcep
 Straight

Catalog #	Size
SF-130-17	17.5 cm (7")



Dressing Forceps
Tupferzangen
Pinzas para tapones
Pincas à tampons
Pinze per tamponi

SF

COTTON SWAB AND DRESSING FORCEPS

Martin Dressing Forcep
Curved

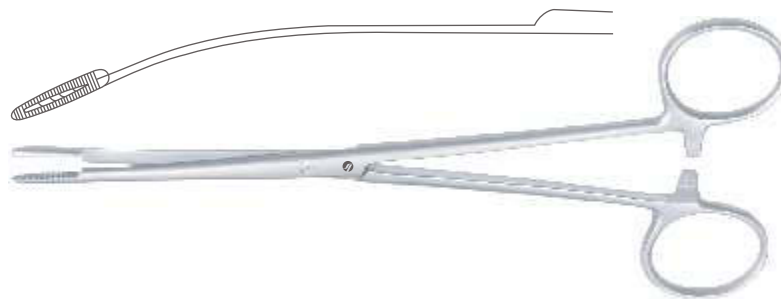

Catalog #	Size
SF-131-17	17 cm (6 3/4")

Gross-Maier Dressing Forcep
Straight, With Ratchet



Catalog #	Size
SF-150-20	20.5 cm (8")
SF-150-22	22 cm (8 3/4")
SF-150-27	26.5 cm (10 1/2")

Gross-Maier Dressing Forcep
Curved, With Ratchet

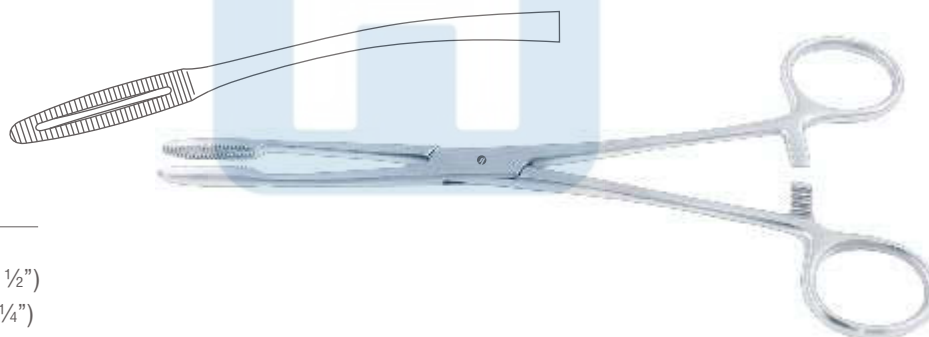

Catalog #	Size
SF-151-20	20 cm (8")
SF-151-22	21.5 cm (8 1/2")
SF-151-27	26 cm (10 1/4")

Gross-Maier Dressing Forcep
Straight, Without Ratchet



Catalog #	Size
SF-152-20	20.5 cm (8")
SF-152-22	22 cm (8 3/4")
SF-152-27	26.5 cm (10 1/2")

Dressing Forceps
 Tupferzangen
 Pinzas para tapones
 Pinces à tampons
 Pinze per tamponi

Gross-Maier Dressing Forcep
 Curved, Without Ratchet

Catalog #	Size
SF-153-20	20 cm (8")
SF-153-22	21.5 cm (8 ½")
SF-153-27	26 cm (10 ¼")



Pelkmann Foreign Body Forcep
 Straight

Catalog #	Size
SF-160-26	26 cm (10 ¼")

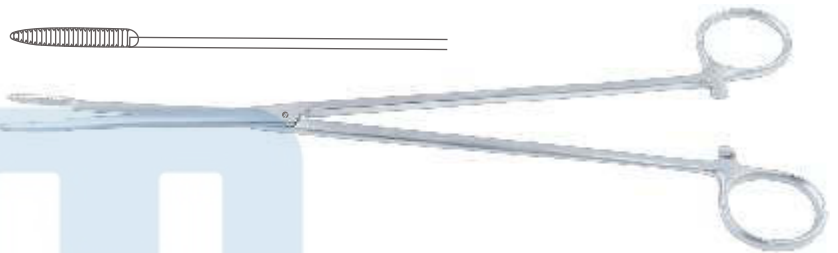

Pelkmann Foreign Body Forcep
 Curved

Catalog #	Size
SF-161-26	26 cm (10 ¼")

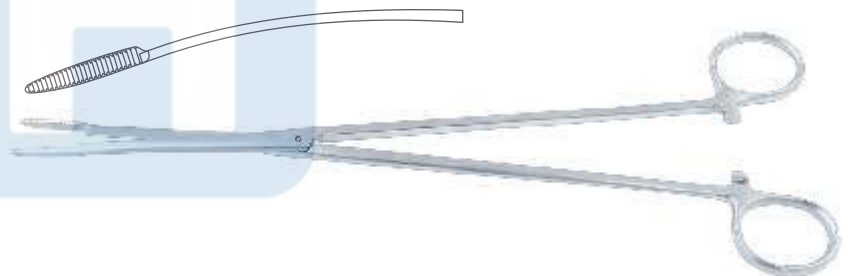

Duplay Sponge Holding Forcep
 Straight

Catalog #	Size
SF-164-21	21 cm (8 ¼")



Duplay Sponge Holding Forcep
 Curved

Catalog #	Size
SF-165-21	21 cm (8 ¼")



Dressing Forceps
Tupferzangen
Pinzas para tapones
Pincas à tampons
Pinze per tamponi

SF

COTTON SWAB AND DRESSING FORCEPS

Tunneling Forcep
Curved



Catalog #	Size
SF-171-40	39.5 cm (15 1/2")

Collin Dressing Forcep
Straight



Catalog #	Size
SF-180-25	25.5 cm (10")

Cheron Dressing Forcep
Straight

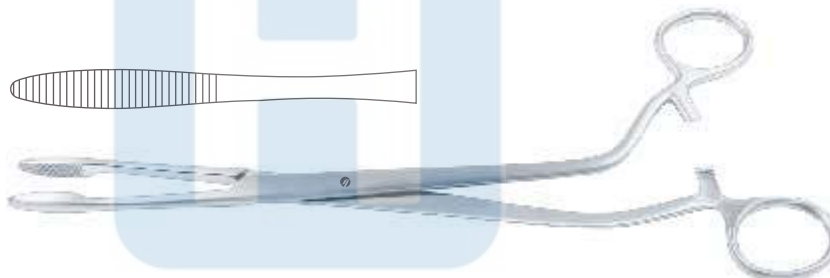

Catalog #	Size
SF-191-25	23.5 cm (9 1/4")

Emmet Dressing Forcep
Straight

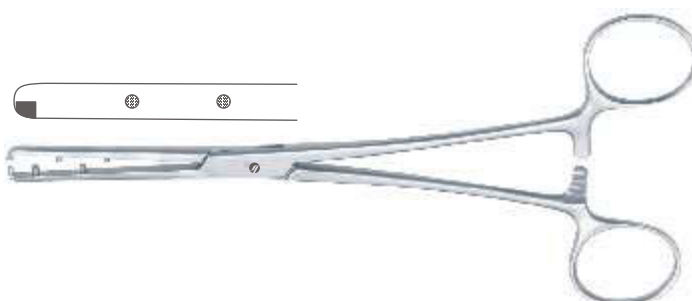

Catalog #	Size
SF-196-21	21 cm (8 1/4")

Bozemann Sponge Holding Forcep
Straight



Catalog #	Size
SF-200-26	26 cm (10 1/4")

Dressing Forceps
 Tupferzangen
 Pinzas para tapones
 Pinces à tampons
 Pinze per tamponi

Bozemann Sponge Holding Forcep
 Curved S Shaped

Catalog #	Size
SF-201-26	26 cm (10 1/4")

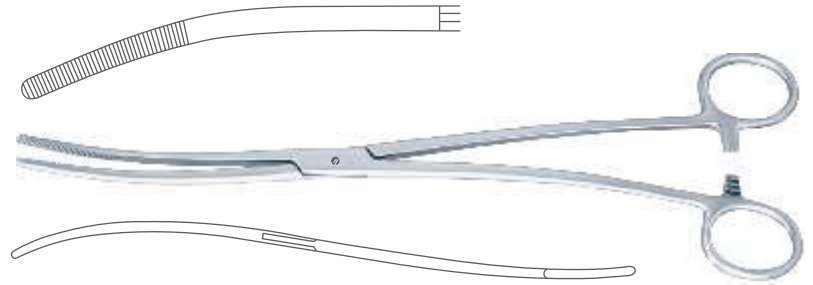

Bozemann-Douglas Sponge Holding Forcep
 Curved S Shaped

Catalog #	Size
SF-203-26	26 cm (10 1/4")

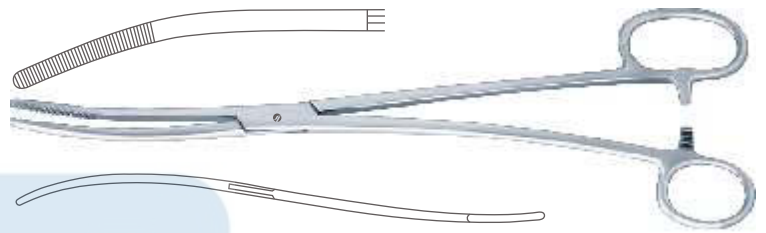

Heywood-Smith Sponge Holding Forcep
 Straight

Catalog #	Size
SF-220-20	20 cm (8")



Heywood-Smith Sponge Holding Forcep
 Straight

Catalog #	Size
SF-222-21	21 cm (8 1/4")



Bergmann Sponge Holding Forcep
 Straight

Catalog #	Size
SF-250-24	24 cm (9 1/2")



Dressing Forceps
Tupferzangen
Pinzas para tapones
Pincas à tampons
Pinze per tamponi

SF

Foerster Sponge Holding Forcep
Straight, Smooth Jaws

Catalog #	Size
SF-300-25	25 cm (9 ¾")



Foerster Sponge Holding Forcep
Curved, Smooth Jaws

Catalog #	Size
SF-301-25	24.5 cm (9 ¾")

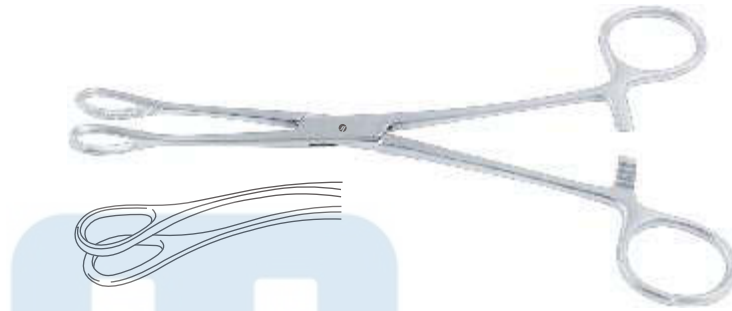

Foerster Sponge Holding Forcep
Straight

Catalog #	Size
SF-350-18	18 cm (7")
SF-350-20	20.5 cm (8")
SF-350-25	25 cm (9 ¾")

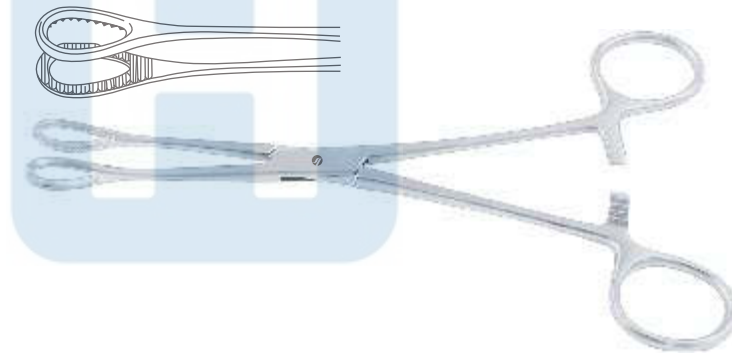

Foerster Sponge Holding Forcep
Curved

Catalog #	Size
SF-351-18	17.5 cm (7")
SF-351-20	20 cm (8")
SF-351-25	24.5 cm (9 ¾")



COTTON SWAB AND DRESSING FORCEPS

Dressing Forceps
 Tupferzangen
 Pinzas para tapones
 Pinces à tampons
 Pinze per tamponi

**Foerster Sponge Holding Forcep
 Straight**

Catalog #	Size
SF-360-25	25 cm (9 3/4")



**Foerster Sponge Holding Forcep
 Curved**

Catalog #	Size
SF-361-25	24.5 cm (9 3/4")

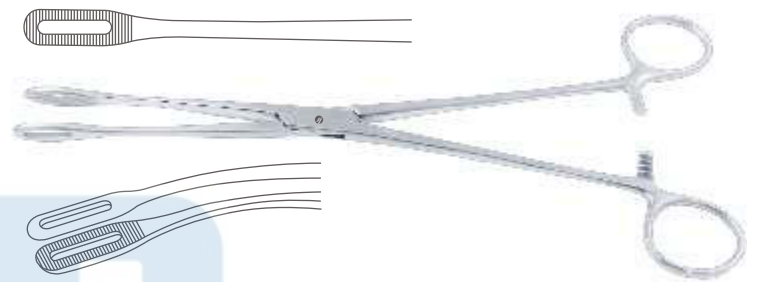

**Ramley Sponge Holding Forcep
 Straight**

Catalog #	Size
SF-380-18	18.5 cm (7 1/4")
SF-380-25	24.5 cm (9 3/4")

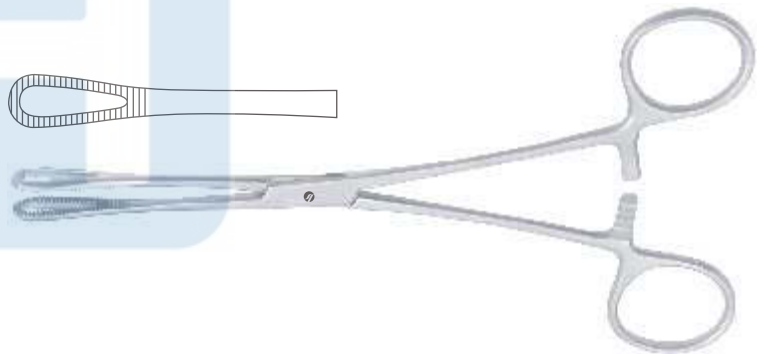

HOSPITA®

ALWAYS THE BEST

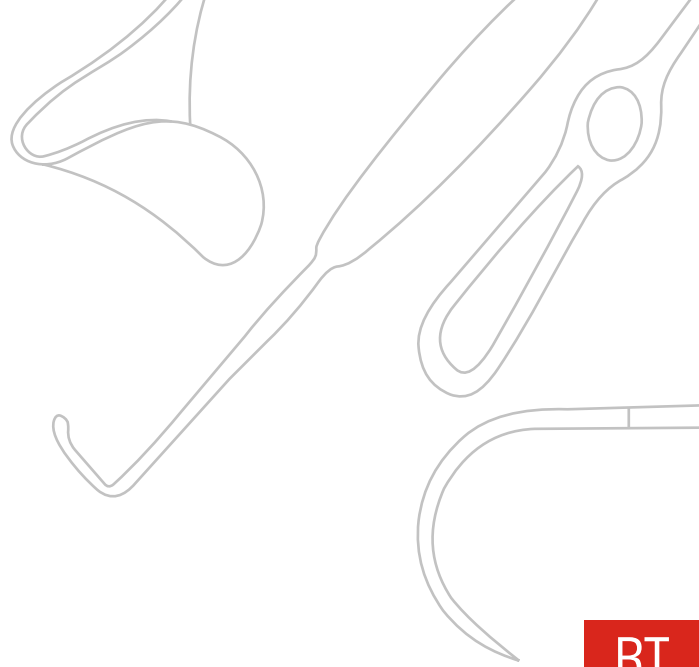

RT

RETRACTORS

The retractor enables the surgeon to either actively separate the edges of a surgical incision or wound, or to hold back underlying organs and tissues, so that body parts under the incision may be accessed. Surtex instruments carry the most versatile range of retractors on the market.

Our range includes hand-held, self-retaining, table and chest mounted types for use in a range of delicate cardio vascular, ENT and general surgical procedures.

Our retractors have an ergonomic feel with specially designed teeth and blades to ensure a non-traumatic grip on sensitive tissue.



Wundhaken

Separadores

Ecarteurs

Divaricatori

Micro Hooklets, Skin Hooks
 Mikrohäkchen, Hauthäkchen
 Micro Ganchitos, Ganchitos de piel
 Micro Crochetes, Crochetes pour le peau
 Micro Divaricatori, Divaricatori per pelle

Gillies Skin Hook



Catalog #	Size, Profile
RT-012-01	18 cm (7"), Fig. 1
RT-012-02	18 cm (7"), Fig. 2



**Kilner Skin Hook
 Sharp**



Catalog #	Size
RT-014-15	14.5 cm (5 3/4")



Frazier Delicate Hook



Catalog #	Size, Profile
RT-016-01	13 cm (5"), Sharp
RT-016-02	13 cm (5"), Blunt



Kleinert-Kutz Delicate Hook

Catalog #	Size, Profile
RT-020-01	16 cm (6 1/4"), Fig. 1
RT-020-02	16 cm (6 1/4"), Fig. 2
RT-020-03	16 cm (6 1/4"), Fig. 3



RT-020-01



RT-020-02



RT-020-03

Graefe Delicate Hook



Catalog #	Size, Profile
RT-024-01	15 cm (6"), Sharp
RT-024-02	15 cm (6"), Blunt



Skin Hooks, Hooklets
 Hauthäkchen, Wundhäkchen
 Ganchitos de piel, Ganchitos
 Crochetes pour le peau, Crochetes
 Divaricatori per pelle, Divaricatori

Skin Hook
 Sharp



Catalog #	Size, Profile
RT-026-01	16 cm (6 1/4"), Fig. 1
RT-026-02	16 cm (6 1/4"), Fig. 2
RT-026-03	16 cm (6 1/4"), Fig. 3
RT-026-04	16 cm (6 1/4"), Fig. 4



O'Connor Skin Hook
 Sharp

Catalog #	Size
RT-030-16	16 cm (6 1/4")

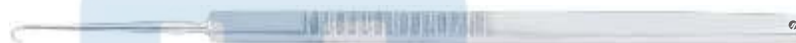

Joseph Mucus Hook
 Sharp

Catalog #	Size
RT-034-15	15.5 cm (6")



Cottle Nasal Hook
 Sharp

Catalog #	Size
RT-036-16	17 cm (6 3/4")



Cottle Nasal Hook
 Sharp

Catalog #	Size, Profile
RT-038-01	14.5 cm (5 3/4"), Fig. 1
RT-038-02	14.5 cm (5 3/4"), Fig. 2
RT-038-03	14.5 cm (5 3/4"), Fig. 3



Nerve Hooks
 Nervhaken
 Ganchos para nervios
 Crochets à nerfs
 Uncini per nervi

Cushing Nerve Hook
 Blunt



Catalog #	Size, Profile
RT-040-01	19 cm (7 1/2"), Fig. 1
RT-040-02	19.5 cm (7 3/4"), Fig. 2



Cushing Nerve Hook
 Blunt



Catalog #	Size, Profile
RT-042-01	28 cm (11"), Fig. 1
RT-042-02	28 cm (11"), Fig. 2



Graefe Nerve Hook
 Blunt

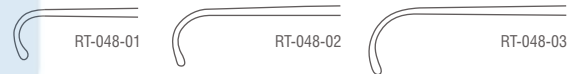

Catalog #	Size, Profile
RT-048-01	14 cm (5 1/2"), Fig. 1
RT-048-02	14 cm (5 1/2"), Fig. 2
RT-048-03	14 cm (5 1/2"), Fig. 3



Crile Nerve Hook



Catalog #	Size
RT-050-20	20 cm (8")

Crile Nerve Hook



Catalog #	Size
RT-052-20	20.5 cm (8")

Skin Hooks, Hooklets
 Hauthäkchen, Wundhäkchen
 Ganchitos de piel, Ganchitos
 Crochetes pour le peau, Crochetes
 Divaricatori per pelle, Divaricatori

Guthrie Skin Retractor
 Sharp



Catalog #	Size, Width
RT-060-01	15.5 cm (6"), 2.0 mm
RT-060-02	15.5 cm (6"), 3.0 mm

Rollet Fine Wound Retractor
 2 Sharp Prongs



Catalog #	Size, Width
RT-062-13	13 cm (5"), 4.5 mm

Rollet Fine Wound Retractor



Catalog #	Size, Width, Profile
RT-064-01	13.5 cm (5 1/4"), 7.0 mm, 4 Sharp Prongs
RT-064-02	13.5 cm (5 1/4"), 7.0 mm, 4 Blunt Prongs

Knapp Fine Wound Retractor
 4 Sharp Prongs

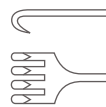

Catalog #	Size
RT-066-13	13.5 cm (5 1/4")

Knapp Fine Wound Retractor
 4 Blunt Prongs

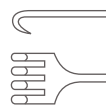

Catalog #	Size
RT-068-13	13.5 cm (5 1/4")

Hooklets
Wundhäkchen
Ganchitos
Crochetes
Divaricatori

McIndoe Wound Retractor
2 Sharp Prongs

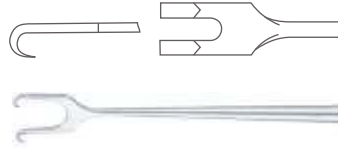

Catalog #	Size, Width
RT-070-01	15 cm (6"), 9.0 mm
RT-070-02	15 cm (6"), 10.0 mm

Freer Mucus Hook
Sharp

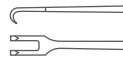

Catalog #	Size, Width
RT-072-15	15 cm (6"), 3.2 mm

Joseph Mucus Hook

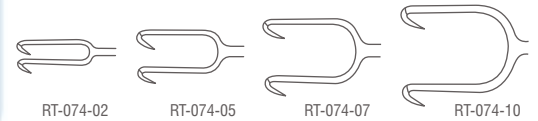

Catalog #	Size, Width
RT-074-02	16.5 cm (6 1/2"), 2.0 mm
RT-074-05	16.5 cm (6 1/2"), 5.0 mm
RT-074-07	16.5 cm (6 1/2"), 7.0 mm
RT-074-10	16.5 cm (6 1/2"), 10 mm



Kilner Alar Hook
Sharp



Catalog #	Size
RT-076-10	8 cm (3 1/4")

Converse Alar Hook
Sharp



Catalog #	Size
RT-078-12	11.5 cm (4 1/2")

Hooklets
Wundhäkchen
Ganchitos
Crochetes
Divaricatori

Cottle Alar Hook
4 Semi Sharp Prongs

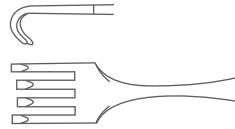

Catalog #	Size
RT-080-14	14 cm (5 1/2")

Tissue Picker
2 Twisted Sharp Prongs



Catalog #	Size, Diameter
RT-084-18	18.5 cm (7 1/4"), Ø 1.8 mm

Wound Retractor
Sharp Prongs, Small Curved

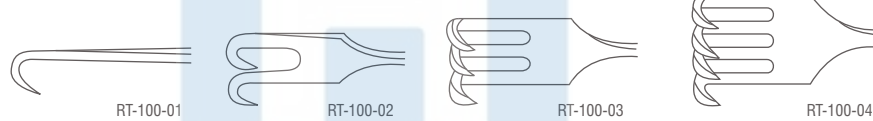

Catalog #	Size, Width
RT-100-01	16.5 cm (6 1/2")
RT-100-02	16.5 cm (6 1/2"), 4.2 mm
RT-100-03	16.5 cm (6 1/2"), 7.0 mm
RT-100-04	16.5 cm (6 1/2"), 9.5 mm



Wound Retractor
Blunt Prongs, Small Curved



Catalog #	Size, Width
RT-101-01	16.5 cm (6 1/2")
RT-101-02	16.5 cm (6 1/2"), 4.2 mm
RT-101-03	16.5 cm (6 1/2"), 7.0 mm
RT-101-04	16.5 cm (6 1/2"), 9.5 mm



Hooklets
Wundhäkchen
Ganchitos
Crochetes
Divaricatori

Wound Retractor
Sharp Flexible Prongs

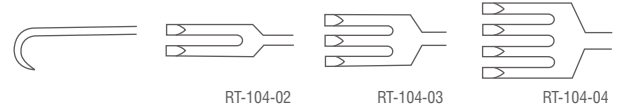

Catalog #	Size
RT-104-02	16 cm (6 1/4")
RT-104-03	16 cm (6 1/4")
RT-104-04	16 cm (6 1/4")



Wound Retractor
Blunt Flexible Prongs

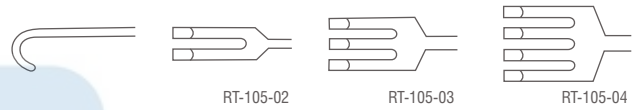

Catalog #	Size
RT-105-02	16 cm (6 1/4")
RT-105-03	16 cm (6 1/4")
RT-105-04	16 cm (6 1/4")



Wound Retractor

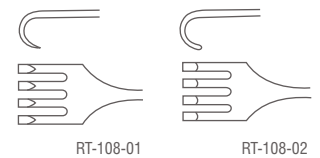

Catalog #	Size, Profile
RT-108-01	16.5 cm (6 1/2"), Sharp
RT-108-02	16.5 cm (6 1/2"), Blunt



Moldestad Vessel Hook



Catalog #	Size, Profile
RT-110-12	12 cm (4 3/4")

Saddle Hooks
 Sattelhäkchen
 Ganchos en forma de silla
 Ecarteurs sous forme de selle
 Divaricatori a forma di sella

Desmarres Lid Retractor

Catalog #	Size, Blade Width
RT-120-08	16 cm (6 ¼"), 8.0 mm
RT-120-10	16 cm (6 ¼"), 10.0 mm
RT-120-12	16 cm (6 ¼"), 12.0 mm
RT-120-14	16 cm (6 ¼"), 14.0 mm
RT-120-16	16 cm (6 ¼"), 16.0 mm
RT-120-18	16 cm (6 ¼"), 18.0 mm

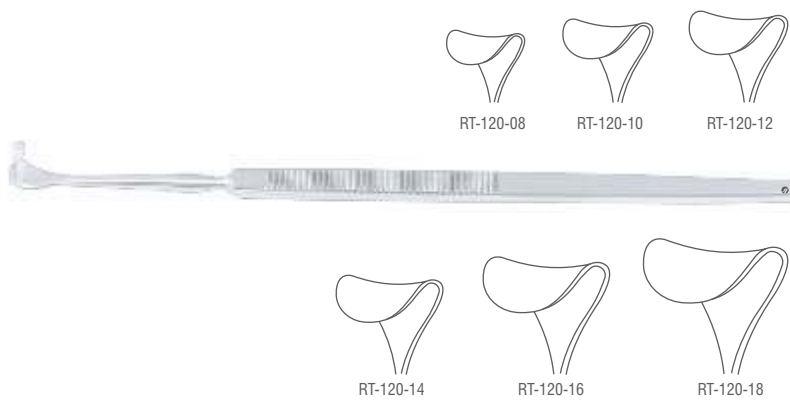

Lid Retractor Hollow Blade

Catalog #	Size, Blade Width
RT-122-12	16 cm (6 ¼"), 12.0 mm
RT-122-14	16 cm (6 ¼"), 14.0 mm
RT-122-16	16 cm (6 ¼"), 16.0 mm
RT-122-18	16 cm (6 ¼"), 18.0 mm

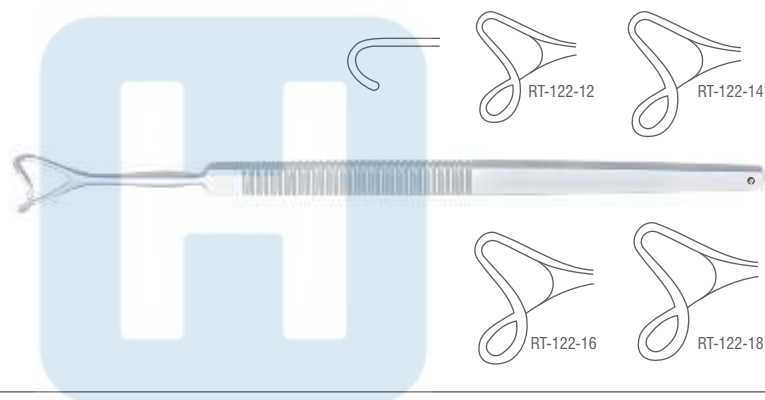

Masing Lid Retractor

Catalog #	Size, Blade Width
RT-124-14	14 cm (5 ½"), 12.0 mm



Cottle Lid Retractor

Catalog #	Size, Blade Width
RT-126-14	14 cm (5 ½"), 12.0 mm



Hooklets
Wundhäkchen
Ganchitos
Crochetes
Divaricatori

Mini-Langenbeck Retractor

Catalog #	Size, Blade Size
RT-130-10	16 cm (6 1/4"), 10 x 6 mm
RT-130-17	16 cm (6 1/4"), 17 x 5 mm
RT-130-20	16 cm (6 1/4"), 20 x 6 mm
RT-130-22	16 cm (6 1/4"), 22 x 8mm

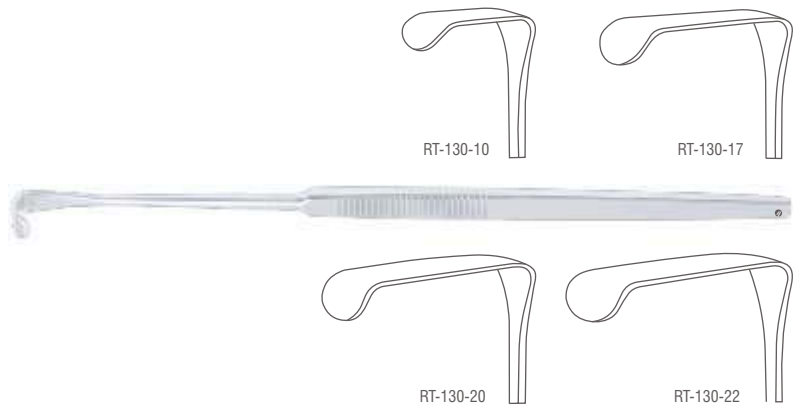

Langenbeck-Green Retractor

Catalog #	Size, Blade Size
RT-132-16	16 cm (6 1/4"), 16 x 6 mm
RT-132-24	16 cm (6 1/4"), 24 x 6 mm

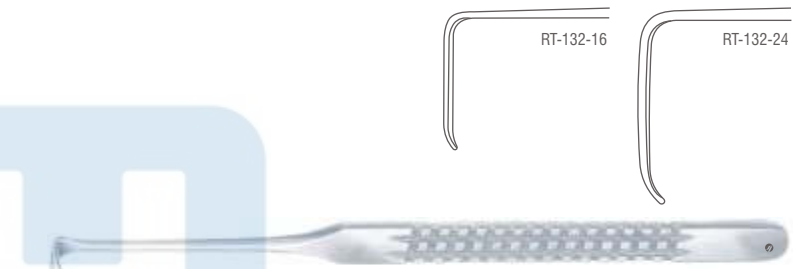

Wound Retractor
Two Blunt Prongs

Catalog #	Size, Blade Size
RT-136-16	16 cm (6 1/4"), 14 x 8 mm



Wound Retractor
Sharp Prongs, Large Curved

Catalog #	Size, Width
RT-140-01	16.5 cm (6 1/2")
RT-140-02	16.5 cm (6 1/2"), 7.5 mm
RT-140-03	16.5 cm (6 1/2"), 10.0 mm
RT-140-04	16.5 cm (6 1/2"), 14.0 mm

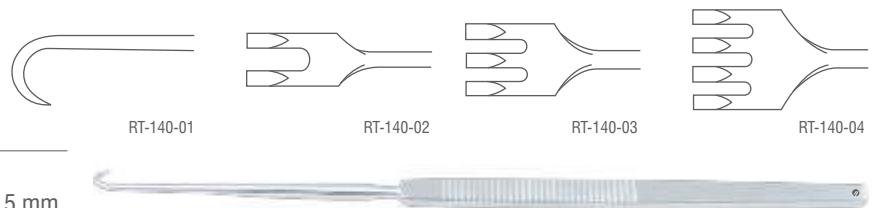

Hooklets
Wundhäkchen
Ganchitos
Crochetes
Divaricatori

Wound Retractor

Blunt Prongs, Large Curved

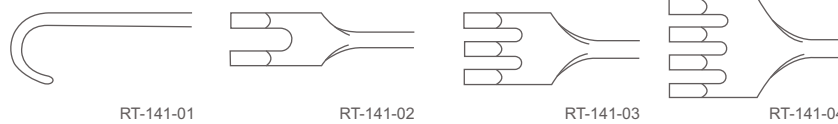

Catalog #	Size, Width
RT-141-01	16.5 cm (6 1/2")
RT-141-02	16.5 cm (6 1/2"), 7.5 mm
RT-141-03	16.5 cm (6 1/2"), 10.0 mm
RT-141-04	16.5 cm (6 1/2"), 14.0 mm



Meyerding Retractor

Catalog #	Size, Profile, Blade Size
RT-150-01	17.5 cm (7"), Blunt, 18 x 7 mm
RT-150-02	17.5 cm (7"), Toothed, 16 x 5 mm
RT-150-03	17.5 cm (7"), Toothed, 17 x 4 mm
RT-150-04	17.5 cm (7"), Blunt, 10 x 3 mm
RT-150-05	17.5 cm (7"), Saddle Shaped, 7 x 4 mm
RT-150-06	17.5 cm (7"), 3 Sharp Prongs, 10 x 4 mm

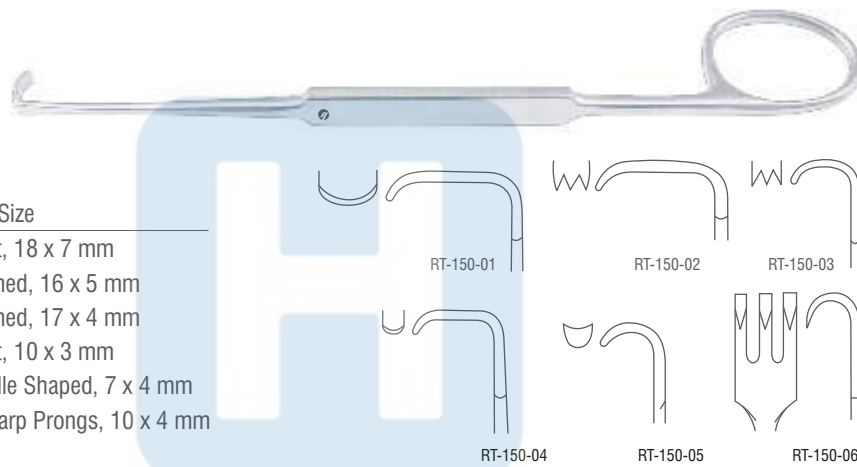

Senn-Green Retractor

Catalog #	Size, Blade Size, Profile
RT-156-01	15 cm (6"), 20 x 6 mm, Fig. 1
RT-156-02	15 cm (6"), 10 x 6 mm, Fig. 2



Ragnell-Davis Retractor

Catalog #	Size, Blade Size
RT-158-14	14 cm (5 1/2"), 8 x 4 mm - 15 x 5.5 mm

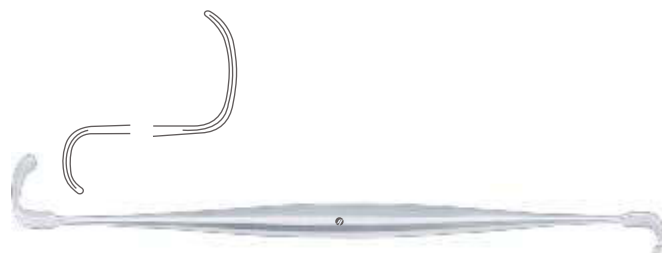

Hooklets, Saddle Hooks
 Wundhäkchen, Sattelhäkchen
 Ganchitos, Ganchos en forma de silla
 Crochetes, Ecarteurs sous forme de selle
 Divaricatori, Divaricatori a forma di sella

**Senn-Miller Retractor
 Sharp**

Catalog #	Size, Blade Size
RT-162-16	16 cm (6 ¼"), 20 x 7 mm

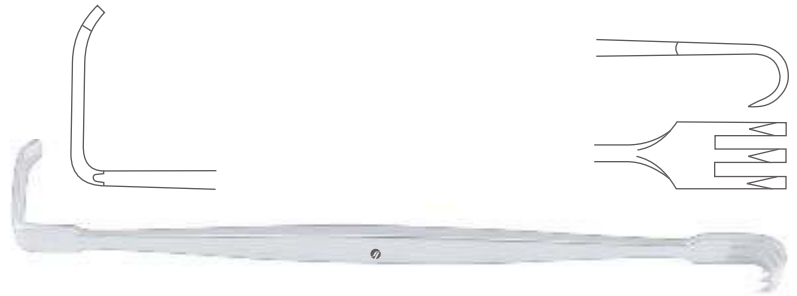

**Senn-Miller Retractor
 Blunt**

Catalog #	Size, Blade Size
RT-163-16	16 cm (6 ¼"), 20 x 7 mm

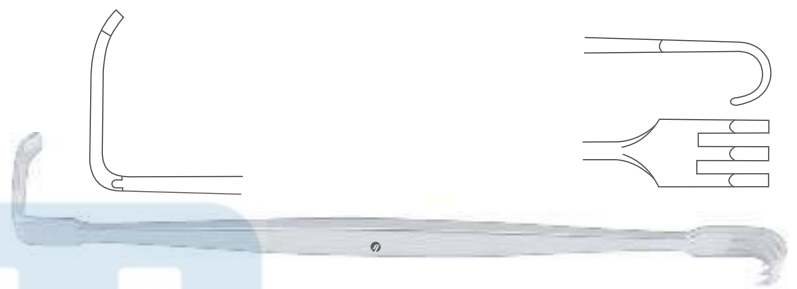

Cushing Retractor/Saddle Hook

Catalog #	Size
RT-170-20	20.5 cm (8")

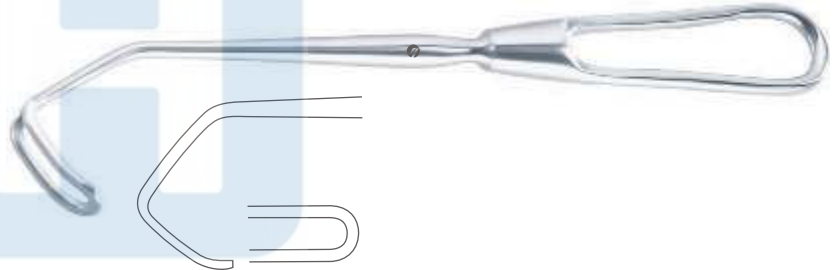

Cushing Retractor/Saddle Hook

Catalog #	Size, Blade Size
RT-172-08	20.5 cm (8"), 8.0 mm
RT-172-10	20.5 cm (8"), 10.0 mm
RT-172-12	20.5 cm (8"), 12.0 mm
RT-172-14	20.5 cm (8"), 14.0 mm
RT-172-16	20.5 cm (8"), 16.0 mm
RT-172-18	20.5 cm (8"), 18.0 mm

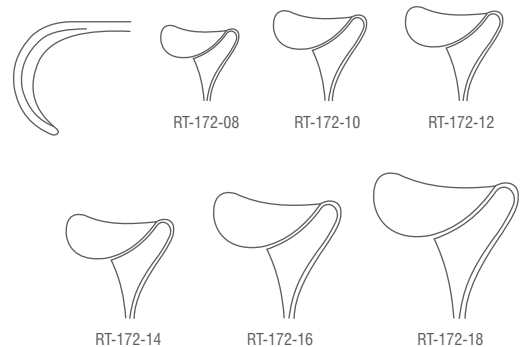

Saddle Hooks, Vein Hooks
 Sattelhäkchen, Venenhäkchen, Wundhäkchen
 Ganchos en forma de silla, Ganchitos para venas
 Ecarteurs sous forme de selle, Ecarteurs pour veines
 Divaricatori a forma di sella, Divaricatori per veni

Cushing Retractor/Saddle Hook

Catalog #	Size, Blade Size
RT-174-08	24 cm (9 1/2"), 8.0 mm
RT-174-10	24 cm (9 1/2"), 10.0 mm
RT-174-12	24 cm (9 1/2"), 12.0 mm
RT-174-14	24 cm (9 1/2"), 14.0 mm
RT-174-16	24 cm (9 1/2"), 16.0 mm
RT-174-18	24 cm (9 1/2"), 18.0 mm

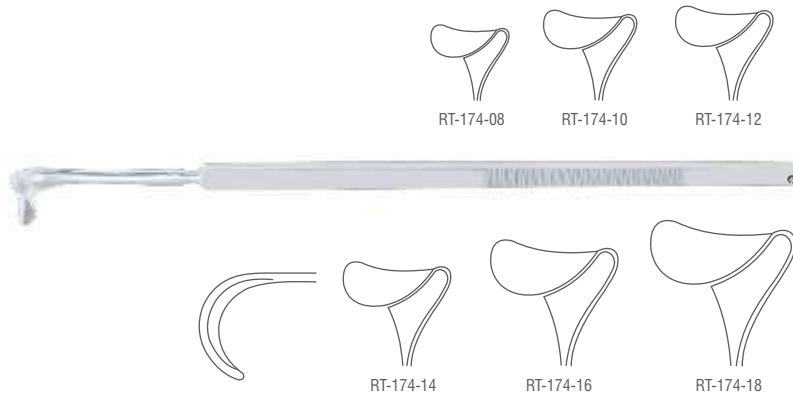

Gil-Vernet Retractor/Saddle Hook

Catalog #	Size, Blade Size
RT-176-08	24 cm (9 1/2"), 8.0 mm
RT-176-11	24 cm (9 1/2"), 11.0 mm
RT-176-15	24 cm (9 1/2"), 15.0 mm
RT-176-17	24 cm (9 1/2"), 17.0 mm
RT-176-20	24 cm (9 1/2"), 20.0 mm
RT-176-23	24 cm (9 1/2"), 23.0 mm

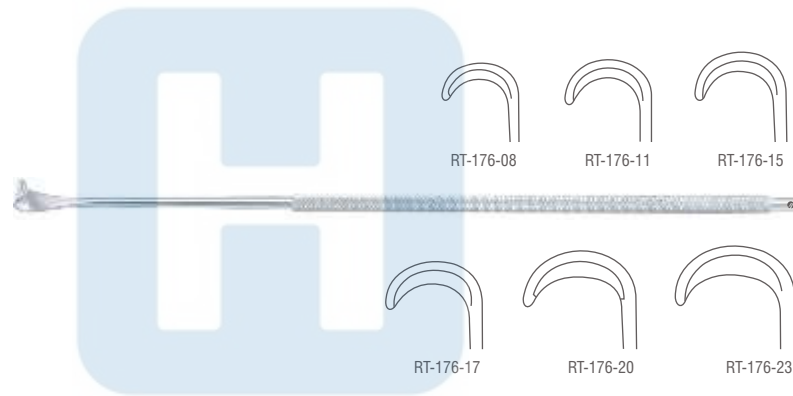

Brom Vein Hook

Catalog #	Size
RT-178-01	19.5 cm (7 3/4")
RT-178-02	19.5 cm (7 3/4")



Strandell-Stille Retractor

Catalog #	Size, Profile
RT-180-01	19 cm (7 3/4"), Smooth
RT-180-02	19 cm (7 3/4"), Toothed



Retractors
Wundhaken, Wundhäkchen
Separadores
Ecarteurs
Divaricatori

Kaye-Millard Retractor
Sharp



Catalog #	Size
RT-184-08	8 cm (3")

Klapp Retractor
Blunt

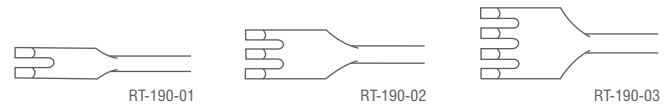

Catalog #	Size, Blade Size, Profile
RT-190-01	17.5 cm (7"), 13 x 6 mm, 2 Prongs
RT-190-02	17.5 cm (7")s, 12 x 11 mm, 3 Prong
RT-190-03	17.5 cm (7"), 15 x 11 mm, 4 Prongs

Wound Retractor
Sharp, 4 Prongs

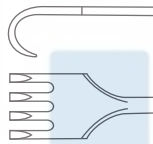

Catalog #	Size
RT-192-04	16.5 cm (6 1/2")

Wound Retractor
Blunt, 4 Prongs

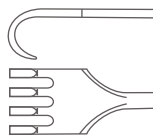

Catalog #	Size
RT-193-04	16.5 cm (6 1/2")

Volkman Retractor
Sharp, Hollow Handle

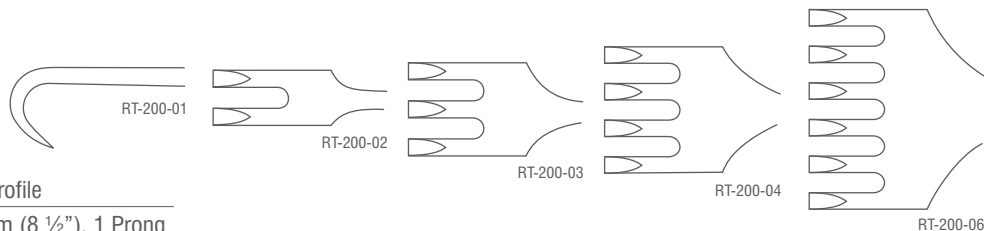

Catalog #	Size, Profile
RT-200-01	21.5 cm (8 1/2"), 1 Prong
RT-200-02	21.5 cm (8 1/2"), 2 Prongs
RT-200-03	21.5 cm (8 1/2"), 3 Prongs
RT-200-04	21.5 cm (8 1/2"), 4 Prongs
RT-200-06	21.5 cm (8 1/2"), 6 Prongs



Retractors
Wundhaken, Wundhäkchen
Separadores
Ecarteurs
Divaricatori

Volkman Retractor
Blunt, Hollow Handle

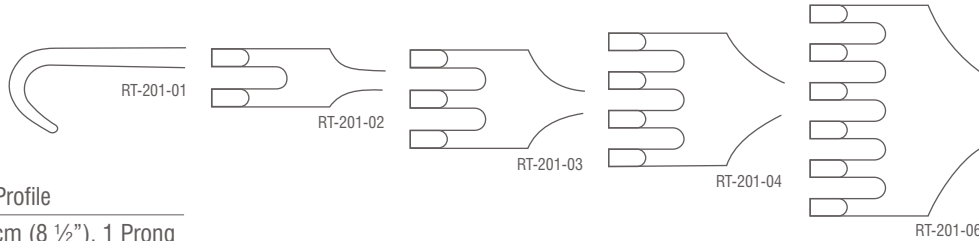

Catalog #	Size, Profile
RT-201-01	21.5 cm (8 1/2"), 1 Prong
RT-201-02	21.5 cm (8 1/2"), 2 Prongs
RT-201-03	21.5 cm (8 1/2"), 3 Prongs
RT-201-04	21.5 cm (8 1/2"), 4 Prongs
RT-201-06	21.5 cm (8 1/2"), 6 Prongs



Volkman Retractor
Sharp

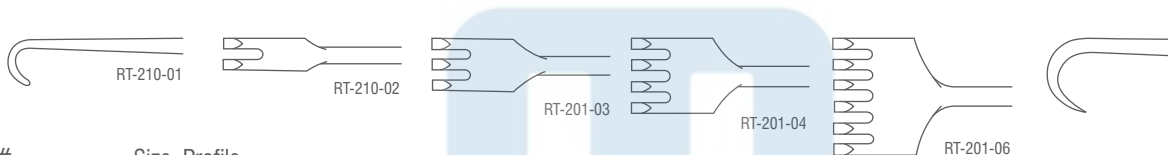

Catalog #	Size, Profile
RT-210-01	22 cm (8 3/4"), 1 Prong
RT-210-02	22 cm (8 3/4"), 2 Prongs
RT-210-03	22 cm (8 3/4"), 3 Prongs
RT-210-04	22 cm (8 3/4"), 4 Prongs
RT-210-06	22 cm (8 3/4"), 6 Prongs



Volkman Retractor
Blunt

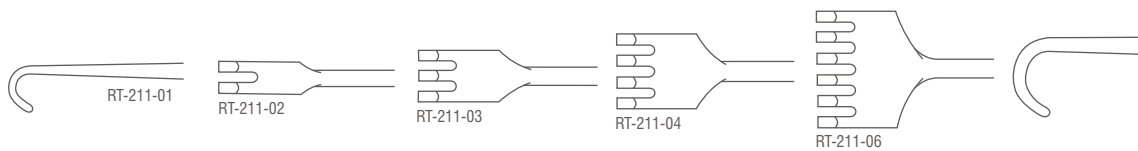

Catalog #	Size, Profile
RT-211-01	22 cm (8 3/4"), 1 Prong
RT-211-02	22 cm (8 3/4"), 2 Prongs
RT-211-03	22 cm (8 3/4"), 3 Prongs
RT-211-04	22 cm (8 3/4"), 4 Prongs
RT-211-06	22 cm (8 3/4"), 6 Prongs



Retractors
Wundhaken, Wundhäkchen
Separadores
Ecarteurs
Divaricatori

**Volkman Retractor
Semi Sharp**

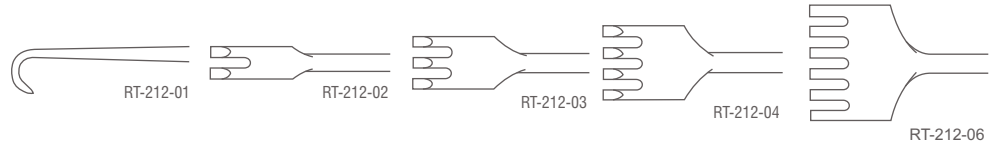

Catalog #	Size, Profile
RT-212-01	22 cm (8 3/4"), 1 Prong
RT-212-02	22 cm (8 3/4"), 2 Prongs
RT-212-03	22 cm (8 3/4"), 3 Prongs
RT-212-04	22 cm (8 3/4"), 4 Prongs
RT-212-06	22 cm (8 3/4"), 6 Prongs



**Volkman Retractor
Sharp, 1 Prong**

Catalog #	Size
RT-214-01	21.5 cm (8 1/2")



**Volkman Retractor
Blunt, 1 Prong**

Catalog #	Size, Profile
RT-215-01	21.5 cm (8 1/2")



**Volkman Retractor
Sharp, 1 Prong**

Catalog #	Size, Profile
RT-218-01	21.5 cm (8 1/2")



Retractors
Wundhaken, Wundhäkchen
Separadores
Ecarteurs
Divaricatori

Kocher Retractor Sharp

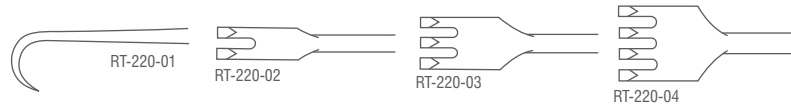

Catalog #	Size, Profile
RT-220-01	22 cm (8 3/4"), 1 Prong
RT-220-02	22 cm (8 3/4"), 2 Prongs
RT-220-03	22 cm (8 3/4"), 3 Prongs
RT-220-04	22 cm (8 3/4"), 4 Prongs
RT-220-06	22 cm (8 3/4"), 6 Prongs
RT-220-08	22 cm (8 3/4"), 8 Prongs

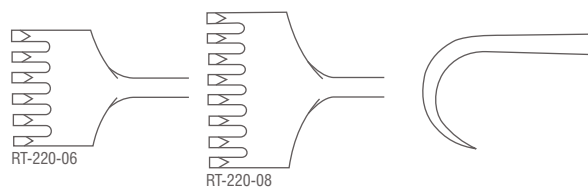

Kocher Retractor Blunt



Catalog #	Size, Profile
RT-221-01	22 cm (8 3/4"), 1 Prong
RT-221-02	22 cm (8 3/4"), 2 Prongs
RT-221-03	22 cm (8 3/4"), 3 Prongs
RT-221-04	22 cm (8 3/4"), 4 Prongs
RT-221-06	22 cm (8 3/4"), 6 Prongs
RT-221-08	22 cm (8 3/4"), 8 Prongs

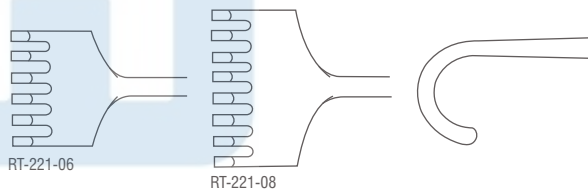

Kocher Retractor Semi Sharp



Catalog #	Size, Profile
RT-222-01	22 cm (8 3/4"), 1 Prong
RT-222-02	22 cm (8 3/4"), 2 Prongs
RT-222-03	22 cm (8 3/4"), 3 Prongs
RT-222-04	22 cm (8 3/4"), 4 Prongs
RT-222-06	22 cm (8 3/4"), 6 Prongs
RT-222-08	22 cm (8 3/4"), 8 Prongs

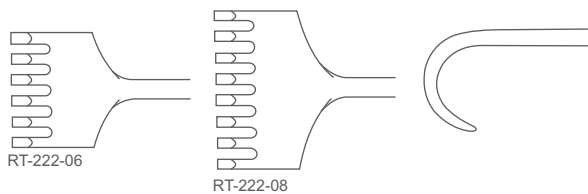

Retractors
Wundhaken, Wundhäkchen
Separadores
Ecarteurs
Divaricatori

Murphy Retractor Sharp

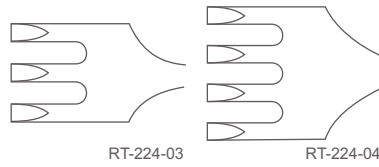

Catalog #	Size, Profile
RT-224-03	19.5 cm (7 3/4"), 3 Prongs
RT-224-04	19.5 cm (7 3/4"), 4 Prongs



Murphy Retractor Blunt

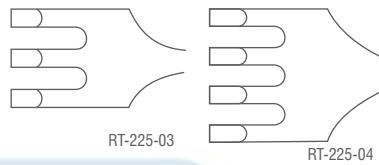

Catalog #	Size, Profile
RT-225-03	19.5 cm (7 3/4"), 3 Prongs
RT-225-04	19.5 cm (7 3/4"), 4 Prongs



Ollier Retractor Blunt

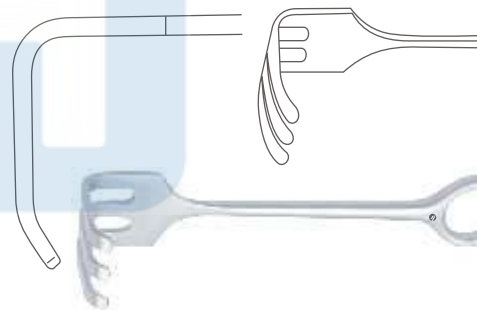

Catalog #	Size, Blade Size, Profile
RT-231-03	23 cm (9"), 36 x 30 mm, 3 Prongs
RT-231-04	23 cm (9"), 36 x 60 mm, 4 Prongs

Wassmund Retractor

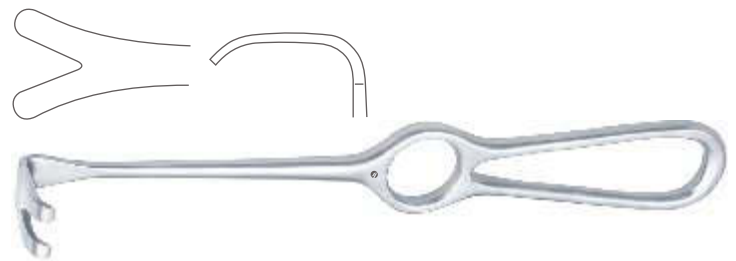

Catalog #	Size, Blade Size
RT-235-02	20.5 cm (8"), 33 x 21 mm

Koerte Retractor Sharp, 8 Prongs



Catalog #	Size, Blade Size
RT-238-08	24.5 cm (9 3/4"), 40 x 30 mm

Retractors
Wundhaken, Wundhäkchen
Separadores
Ecarteurs
Divaricatori

Koerte Retractor
Blunt, 8 Prongs



Catalog #	Size, Blade Size
RT-239-08	24.5 cm (9 3/4"), 40 x 30 mm

Israel Retractor
Blunt, 4 prongs



Catalog #	Size, Blade Size, Profile
RT-241-04	25.5 cm (10"), 40 x 40 mm, Blunt, 4 Prongs
RT-243-05	25.5 cm (10"), 45 x 50 mm, Blunt, 5 Prongs
RT-245-06	25.5 cm (10"), 50 x 60 mm, Blunt, 6 Prongs
RT-247-07	25.5 cm (10"), 70 x 70 mm, Blunt, 7 Prongs

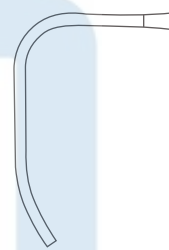
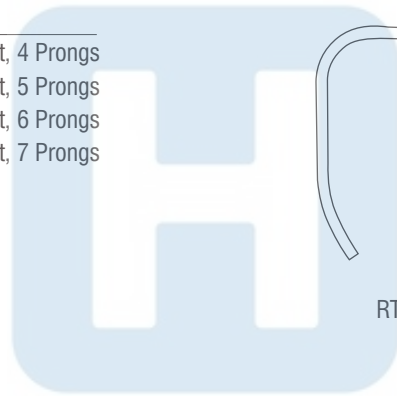

RT-241-04

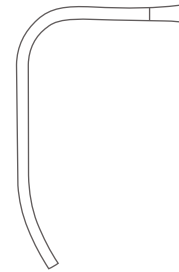

RT-243-05

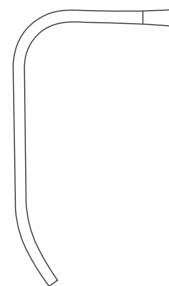

RT-245-06

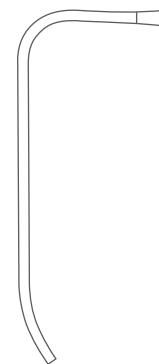

RT-247-07

Retractors
Wundhaken, Wundhäkchen
Separadores
Ecarteurs
Divaricatori

Langenbeck Retractor

Catalog #	Size, Blade Size
RT-251-01	22.5 cm (8 3/4"), 30 x 11 mm
RT-251-02	22.5 cm (8 3/4"), 30 x 14 mm
RT-251-03	22.5 cm (8 3/4"), 30 x 16 mm
RT-251-04	22.5 cm (8 3/4"), 40 x 11 mm
RT-251-05	22.5 cm (8 3/4"), 50 x 11 mm

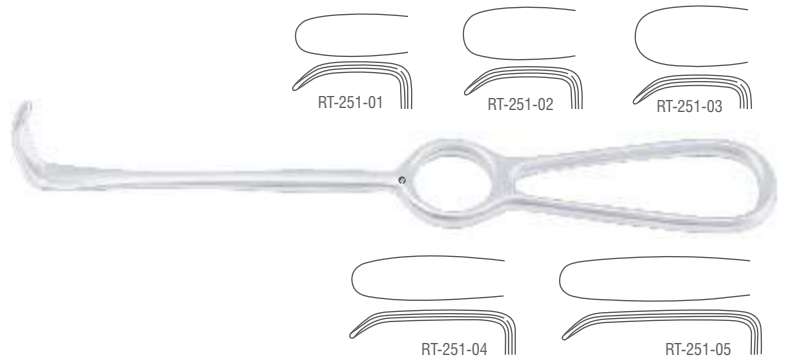

**Langenbeck Retractor
Hollow Handle**

Catalog #	Size, Blade Size
RT-253-01	22.5 cm (8 3/4"), 30 x 11 mm
RT-253-02	22.5 cm (8 3/4"), 30 x 14 mm
RT-253-03	22.5 cm (8 3/4"), 30 x 16 mm
RT-253-04	22.5 cm (8 3/4"), 40 x 11 mm
RT-253-05	22.5 cm (8 3/4"), 50 x 11 mm

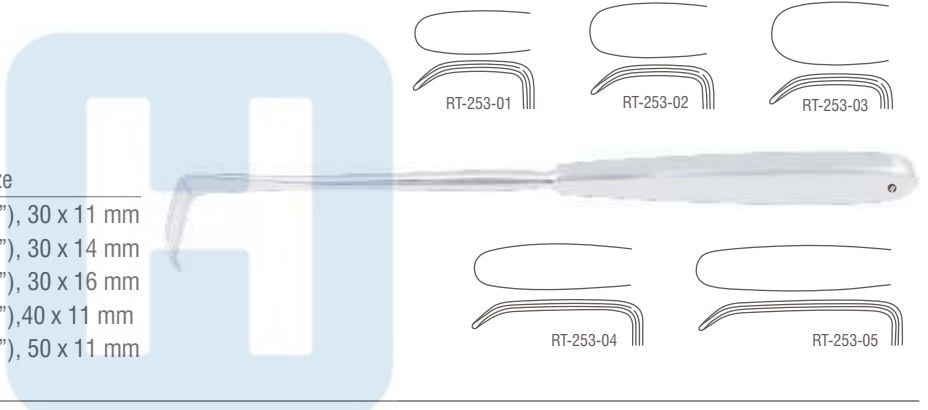

Langenbeck Retractor

Catalog #	Size, Blade Size
RT-255-00	22.5 cm (8 3/4"), 33 x 14 mm



Langenbeck Retractor

Catalog #	Size, Blade Size
RT-257-01	21 cm (8 1/4"), 55 x 20 mm
RT-257-02	21 cm (8 1/4"), 60 x 20 mm
RT-257-03	21 cm (8 1/4"), 63 x 20 mm



Retractors
Wundhaken, Wundhäkchen
Separadores
Ecarteurs
Divaricatori

Langenbeck Retractor

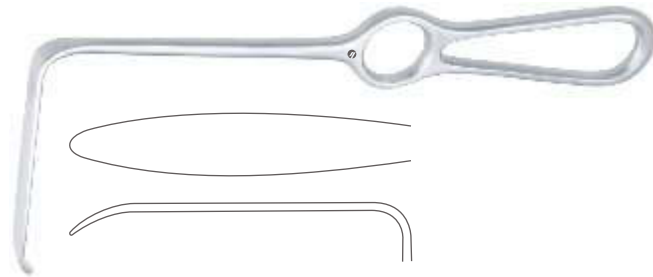

Catalog #	Size, Blade Size
RT-259-22	22.5 cm (8 3/4"), 85 x 15 mm

Lahey Retractor

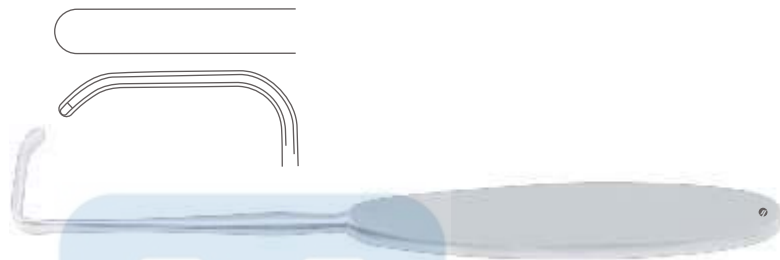

Catalog #	Size, Blade Size
RT-271-19	19.5 cm (7 3/4"), 31 x 6 mm

Little Retractor



Catalog #	Size, Blade Size
RT-275-20	20 cm (8"), 13 x 15 mm

Kocher Retractor

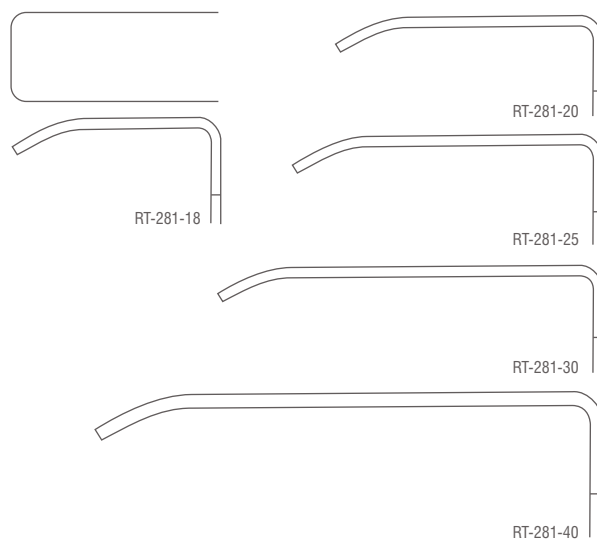

Catalog #	Size, Blade Size
RT-281-18	23 cm (9"), 41 x 18 mm
RT-281-20	23 cm (9"), 61 x 20 mm
RT-281-25	23 cm (9"), 61 x 25 mm
RT-281-30	23 cm (9"), 75 x 30 mm
RT-281-40	23 cm (9"), 75 x 40 mm



Retractors
Wundhaken, Wundhäkchen
Separadores
Ecarteurs
Divaricatori

Kocher-Langenbeck Retractor

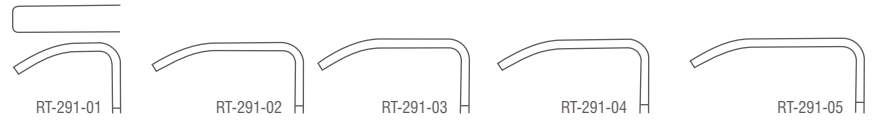

Catalog #	Size, Blade Size
RT-291-01	21.5 cm (8 1/2"), 25 x 6 mm
RT-291-02	21.5 cm (8 1/2"), 35 x 8 mm
RT-291-03	21.5 cm (8 1/2"), 35 x 11 mm
RT-291-04	21.5 cm (8 1/2"), 35 x 15 mm
RT-291-05	21.5 cm (8 1/2"), 40 x 11 mm
RT-291-06	21.5 cm (8 1/2"), 55 x 11 mm
RT-291-07	21.5 cm (8 1/2"), 70 x 14 mm
RT-291-08	21.5 cm (8 1/2"), 80 x 12 mm
RT-291-09	21.5 cm (8 1/2"), 80 x 16 mm

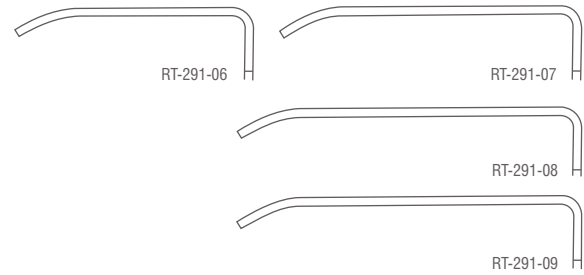

Kocher-Langenbeck Retractor

Catalog #	Size, Blade Size
RT-293-01	21.5 cm (8 1/2"), 25 x 10 mm
RT-293-02	21.5 cm (8 1/2"), 40 x 13 mm
RT-293-03	21.5 cm (8 1/2"), 60 x 13 mm
RT-293-04	21.5 cm (8 1/2"), 40 x 18 mm
RT-293-05	21.5 cm (8 1/2"), 60 x 18 mm
RT-293-06	21.5 cm (8 1/2"), 85 x 18 mm
RT-293-07	21.5 cm (8 1/2"), 60 x 25 mm
RT-293-08	21.5 cm (8 1/2"), 85 x 25 mm

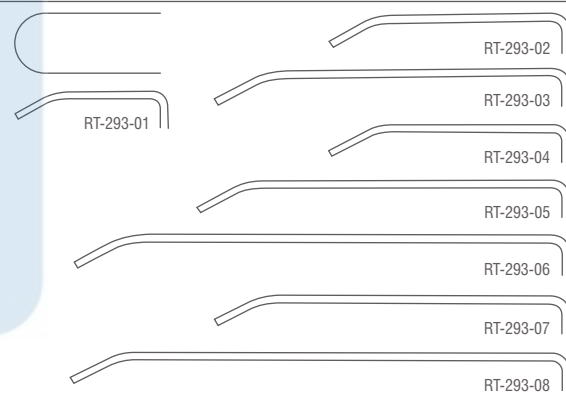

Sauerbruch Retractor

Catalog #	Size, Blade Size
RT-295-01	22.5 cm (8 3/4"), 45 x 15 mm
RT-295-02	22.5 cm (8 3/4"), 60 x 23 mm
RT-295-03	22.5 cm (8 3/4"), 72 x 20 mm

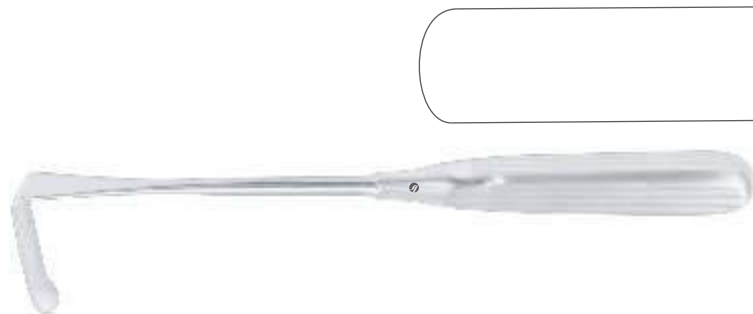

Retractors
Wundhaken, Wundhäkchen
Separadores
Ecarteurs
Divaricatori

Kirsch Retractor

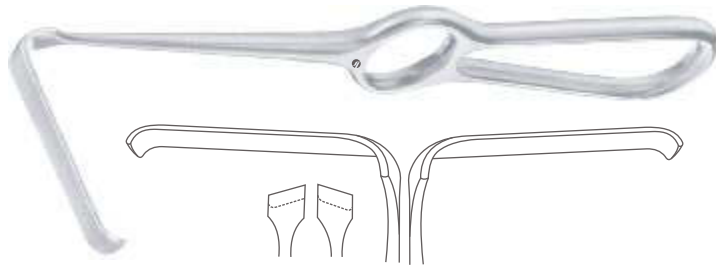

Catalog #	Size, Blade Size, Profile
RT-297-01	21 cm (8 1/4"), 60 x 11 mm, Left
RT-297-02	21 cm (8 1/4"), 60 x 11 mm, Right

Zenker Retractor

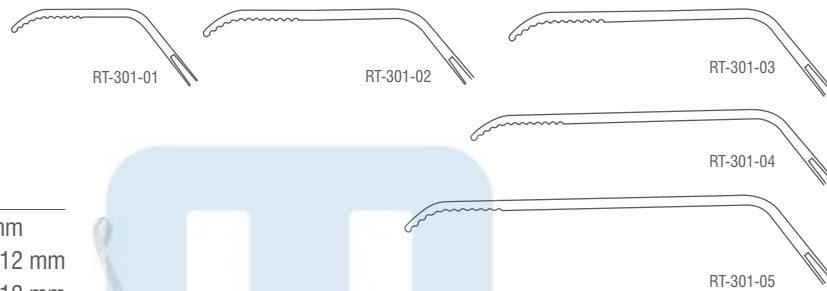

Catalog #	Size, Blade Size
RT-301-01	25 cm (9 3/4"), 35 x 8 mm
RT-301-02	26.5 cm (10 1/2"), 60 x 12 mm
RT-301-03	27.5 cm (10 3/4"), 75 x 12 mm
RT-301-04	28.5 cm (11 1/4"), 85 x 20 mm
RT-301-05	30.5 cm (12"), 100 x 25 mm

Koenig Retractor



Catalog #	Size, Blade Size
RT-305-01	18 cm (7"), 13 x 13 mm
RT-305-02	18 cm (7"), 12 x 16 mm

Cushing-Kocher Retractor



Catalog #	Size, Blade Size
RT-305-17	17.5 cm (7"), 10 x 10 mm

Retractors
Wundhaken, Wundhäkchen
Separadores
Ecarteurs
Divaricatori

Kocher Retractor

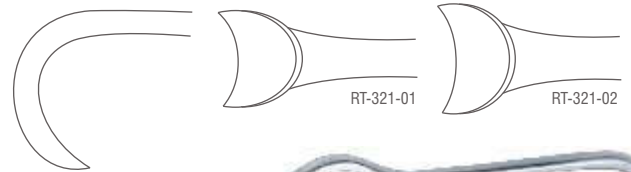

Catalog #	Size, Blade Size
RT-321-01	21.5 cm (8 1/2"), 22 x 12 mm
RT-321-02	21.5 cm (8 1/2"), 24 x 14 mm



Kocher Retractor

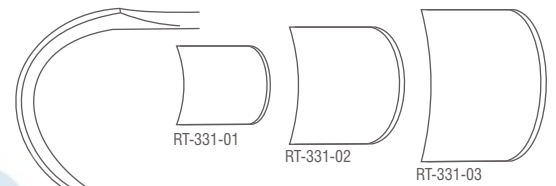

Catalog #	Size, Blade Size
RT-331-01	22 cm (8 1/2"), 42 x 10 mm
RT-331-02	23 cm (9"), 42 x 15 mm
RT-331-03	23 cm (9"), 43 x 20 mm



Schoenborn Retractor



Catalog #	Size, Blade Size
RT-335-20	20 cm (8"), 13 x 6 mm

Wound Retractor
Double Ended



Catalog #	Size, Blade Size
RT-337-20	20.5 cm (8"), 20 x 19 mm

Dissecting Hook
For Longitudinal Dissection of Vessels

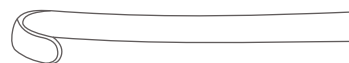

Catalog #	Size
RT-341-23	23.5 cm (9 1/2")

Retractors
Wundhaken, Wundhäkchen
Separadores
Ecarteurs
Divaricatori

Durham Retractor



Catalog #	Size, Blade Size
RT-351-21	21.5 cm (8 1/2"), 16 x 25 mm

Middeldorf Retractor

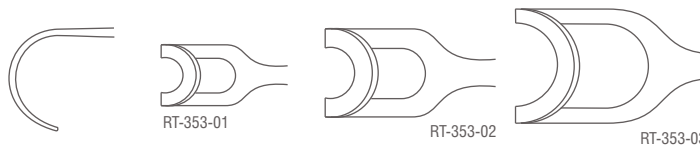

Catalog #	Size, Blade Size
RT-353-01	21.5 cm (8 1/2"), 15 x 17 mm
RT-353-02	23 cm (9"), 22 x 22 mm
RT-353-03	24.5 cm (9 3/4"), 26 x 31 mm



Middeldorf Retractor

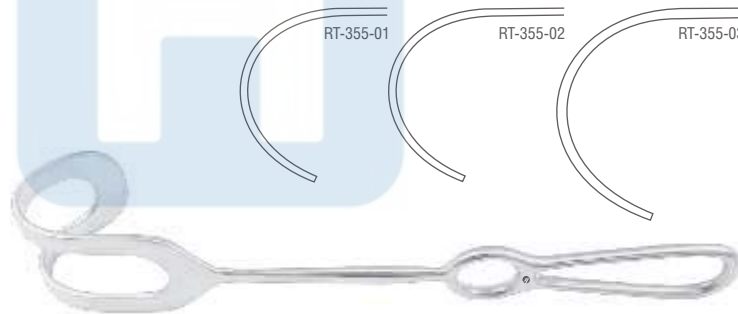

Catalog #	Size, Blade Size
RT-355-01	27 cm (10 3/4"), 48 x 45 mm
RT-355-02	27 cm (10 3/4"), 52 x 50 mm
RT-355-03	28 cm (11"), 60 x 70 mm

Greene Retractor

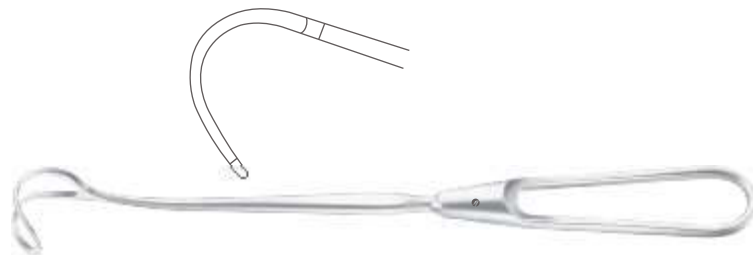

Catalog #	Size, Blade Size
RT-357-22	22.5 cm (8 3/4"), 22 x 22 mm

Buchs Retractor



Catalog #	Size, Blade Size
RT-361-20	20.5 cm (8"), 38 x 18 mm

Retractors
Wundhaken, Wundhäkchen
Separadores
Ecarteurs
Divaricatori

Kraemer Retractor



Catalog #	Size, Blade Size
RT-363-21	21 cm (8 1/4"), 66 x 10 mm

Caspar Retractor



Catalog #	Size, Blade Size
RT-365-21	21 cm (8 1/4"), 67 x 17 mm

Dockhorn Retractor



Catalog #	Size, Blade Size
RT-367-01	21 cm (8 1/4"), 40 x 12 mm
RT-367-02	21 cm (8 1/4"), 55 x 14 mm

Martin Retractor

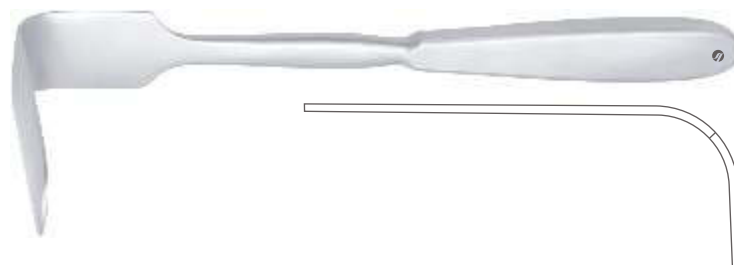

Catalog #	Size, Blade Size
RT-371-25	26 cm (10 1/4"), 110 x 27 mm

Simon Retractor

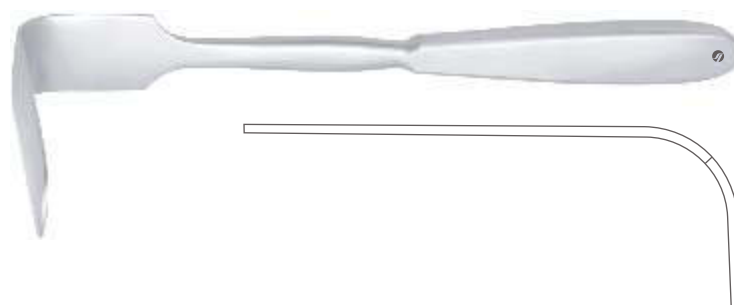

Catalog #	Size, Blade Size
RT-373-01	28 cm (11"), 115 x 22 mm
RT-373-02	28 cm (11"), 115 x 27 mm

Retractors
Wundhaken, Wundhäkchen
Separadores
Ecarteurs
Divaricatori

RT

RETRACTORS

Brunner Retractor

Catalog #	Size, Blade Size
RT-375-08	25.5 cm (10"), 84 x 20 mm
RT-375-10	25.5 cm (10"), 104 x 25 mm
RT-375-12	25.5 cm (10"), 124 x 30 mm
RT-375-13	25.5 cm (10"), 130 x 30 mm
RT-375-14	25.5 cm (10"), 144 x 30 mm
RT-375-16	25.5 cm (10"), 160 x 30 mm
RT-375-18	25.5 cm (10"), 164 x 30 mm

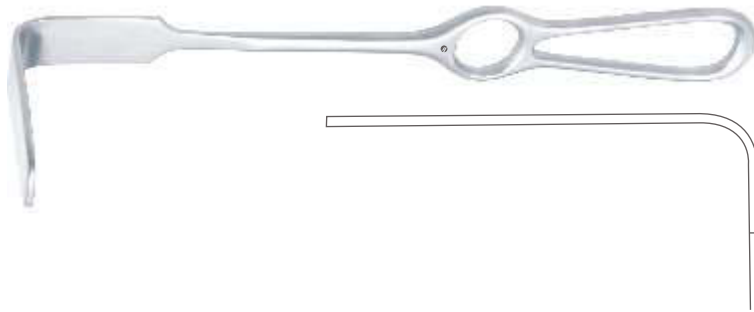

Brunner Retractor

Catalog #	Size, Blade Size
RT-377-08	25.5 cm (10"), 82 x 20 mm
RT-377-10	25.5 cm (10"), 102 x 20 mm
RT-377-12	25.5 cm (10"), 122 x 30 mm
RT-377-14	25.5 cm (10"), 140 x 25 mm
RT-377-16	25.5 cm (10"), 162 x 30 mm
RT-377-18	25.5 cm (10"), 182 x 30 mm

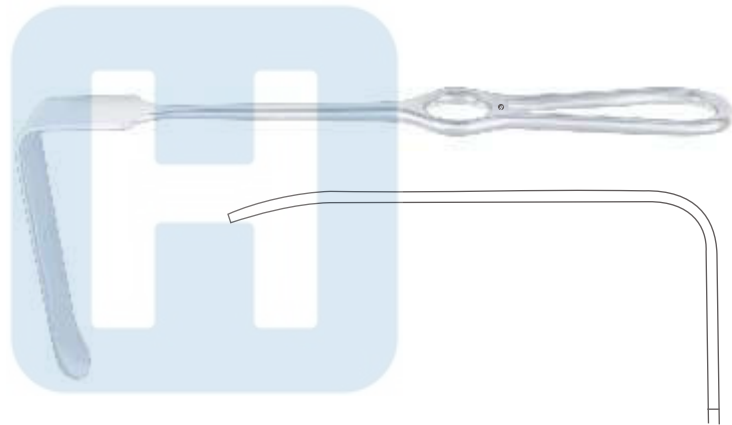

Coryllos Retractor

Catalog #	Size, Blade Size
RT-381-01	24 cm (9 1/2"), 85 x 22 mm
RT-381-02	24 cm (9 1/2"), 108 x 43 mm
RT-381-03	24 cm (9 1/2"), 119 x 65 mm

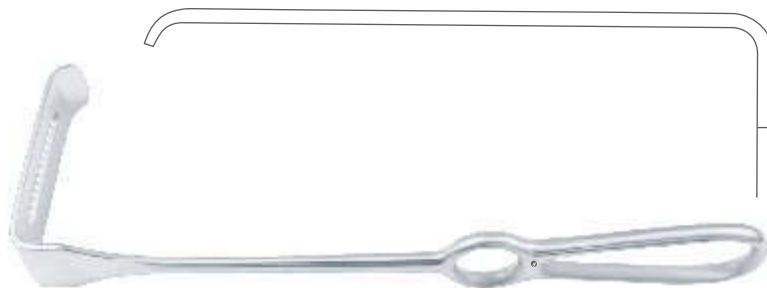

Davidson Scapula Retractor

Catalog #	Size, Blade Size
RT-385-01	19 cm (7 1/2"), 80 x 54 mm
RT-385-02	18.5 cm (7 1/4"), 80 x 95 mm



Retractors
Wundhaken, Wundhäkchen
Separadores
Ecarteurs
Divaricatori

Sauerbruch Retractor



Catalog #	Size, Blade Size
RT-387-25	25.5 cm (10"), 127 x 38 mm

Richardson-Eastman Retractor



Catalog #	Size, Blade Size, Profile
RT-400-00	Set of Fig.1 & Fig. 2
RT-400-01	26 cm (10 1/4"), 28 x 20 mm-36 x 28 mm, Fig. 1
RT-400-02	27 cm (10 3/4"), 49 x 38 mm-63 x 49 mm, Fig. 2

Richardson Retractor



Catalog #	Size, Blade Size
RT-403-01	23.5 cm (9 1/4"), 25 x 21 mm
RT-403-02	24 cm (9 1/2"), 30 x 29 mm
RT-403-03	24 cm (9 1/2"), 38 x 40 mm

Richardson Retractor



Catalog #	Size, Blade Size
RT-405-24	24 cm (9 1/2"), 48 x 22 mm

Retractors
Wundhaken, Wundhäkchen
Separadores
Ecarteurs
Divaricatori

Kelly Retractor

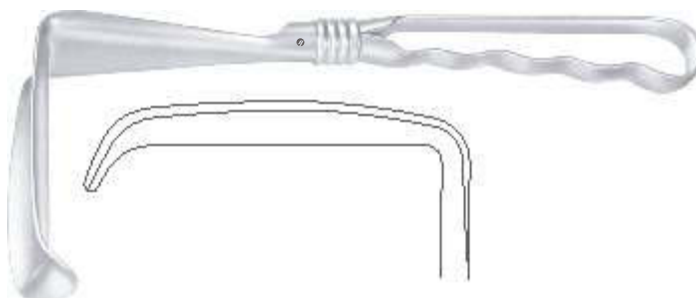

Catalog #	Size, Blade Size
RT-409-01	26 cm (10 1/4"), 50 x 40 mm
RT-409-02	26 cm (10 1/4"), 62 x 50 mm
RT-409-03	26 cm (10 1/4"), 70 x 65 mm
RT-409-04	26 cm (10 1/4"), 90 x 76 mm

Tuffier Retractor



Catalog #	Size, Blade Size
RT-413-21	21.5 cm (8 1/2"), 58 x 64 mm

Morris Retractor



Catalog #	Size, Blade Size
RT-415-01	24.5 cm (9 3/4"), 70 x 40 mm
RT-415-02	24.5 cm (9 3/4"), 70 x 50 mm
RT-415-03	24.5 cm (9 3/4"), 70 x 65 mm

Tudor-Edwards Retractor



Catalog #	Size, Blade Size
RT-417-20	20.5 cm (8"), 55 x 47 mm

Retractors
Wundhaken, Wundhäkchen
Separadores
Ecarteurs
Divaricatori

Meyering Retractor

Catalog #	Size, Blade Size
RT-419-01	23 cm (9"), 52 x 16 mm
RT-419-02	23 cm (9"), 76 x 25 mm
RT-419-03	25.5 cm (10"), 89 x 50 mm



Doyen Retractor

Catalog #	Size, Blade Size
RT-423-01	24 cm (9 1/2"), 45 x 88 mm
RT-423-02	25 cm (9 3/4"), 53 x 80 mm
RT-423-03	25 cm (9 3/4"), 78 x 82 mm



Doyen Retractor

Catalog #	Size, Blade Size
RT-431-01	28 cm (11"), 48 x 90 mm
RT-431-02	28 cm (11"), 48 x 105 mm
RT-431-03	28 cm (11"), 48 x 120 mm
RT-431-04	28 cm (11"), 48 x 135 mm



Chain With Weight

For Use with RT-431-01 to 431-04

Catalog #	Size
RT-431-10	79 cm (31")



Retractors
Wundhaken, Wundhäkchen
Separadores
Ecarteurs
Divaricatori

RT

RETRACTORS

Kocher Retractor



Catalog #	Size, Blade Size
RT-435-22	24 cm (9 1/2"), 73 x 25 mm

Kocher Retractor



Catalog #	Size, Blade Size
RT-437-01	25 cm (9 3/4"), 80 x 45 mm
RT-437-02	25 cm (9 3/4"), 80 x 55 mm
RT-437-03	25 cm (9 3/4"), 80 x 65 mm

Doyen-Stille Retractor

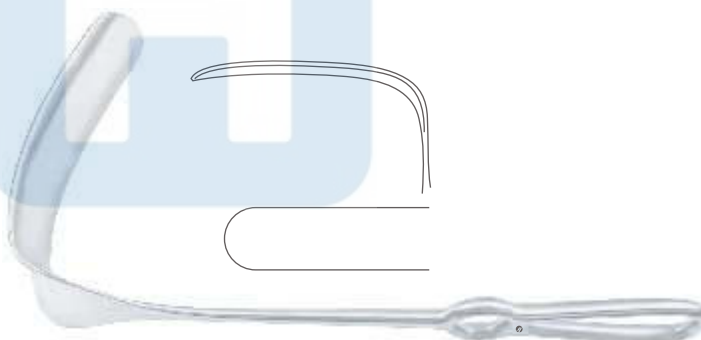

Catalog #	Size, Blade Size
RT-441-01	26 cm (10 1/4"), 87 x 28 mm
RT-441-02	26 cm (10 1/4"), 97 x 31 mm
RT-441-03	26 cm (10 1/4"), 117 x 52 mm

Fritsch Retractor



Catalog #	Size, Blade Size
RT-445-01	23.5 cm (9 1/4"), 37 x 31 mm
RT-445-02	24 cm (9 1/2"), 38 x 40 mm
RT-445-03	25 cm (9 3/4"), 43 x 51 mm
RT-445-04	25 cm (9 3/4"), 49 x 61 mm
RT-445-05	25.5 cm (10"), 48 x 75 mm
RT-445-06	26.5 cm (10 1/2"), 65 x 85 mm

Retractors
Wundhaken, Wundhäkchen
Separadores
Ecarteurs
Divaricatori

Hoesel Retractor

Catalog #	Size, Blade Size
RT-449-01	26 cm (10 ¼"), 63 x 21 mm
RT-449-02	26 cm (10 ¼"), 83 x 30 mm
RT-449-03	26 cm (10 ¼"), 103 x 30 mm
RT-449-04	26 cm (10 ¼"), 120 x 30 mm
RT-449-05	26 cm (10 ¼"), 140 x 30 mm
RT-449-06	26 cm (10 ¼"), 140 x 40 mm

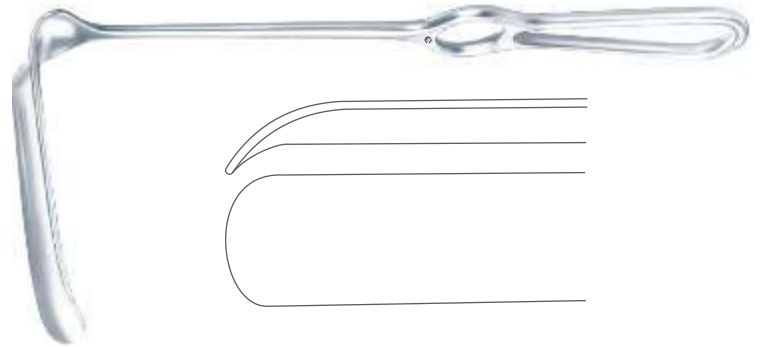

Ross Aorta Retractor
Flexible Shaft

Catalog #	Size, Profile
RT-455-01	25.5 cm (10"), Fig. 1
RT-455-02	25.5 cm (10"), Fig. 2
RT-455-03	25.5 cm (10"), Fig. 3
RT-455-04	25.5 cm (10"), Fig. 4
RT-455-05	25.5 cm (10"), Fig. 5
RT-455-06	25.5 cm (10"), Fig. 6

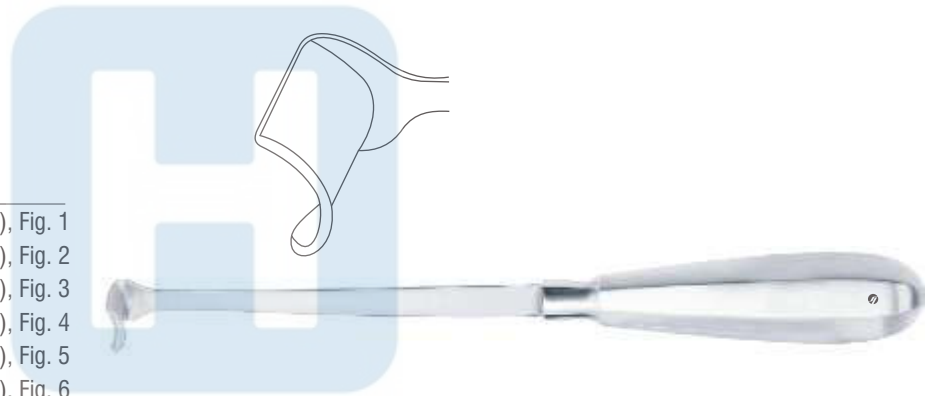

Polloson Retractor

Catalog #	Size
RT-459-27	29 cm (11 ½")



Polloson Retractor

Catalog #	Size
RT-461-27	25.5 cm (10")



Retractors
Wundhaken, Wundhäkchen
Separadores
Ecarteurs
Divaricatori

Harrington Retractor

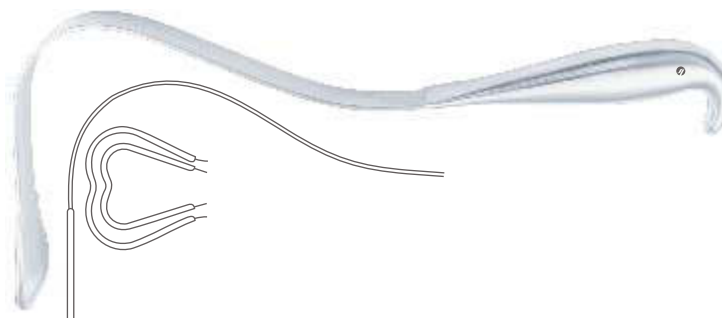

Catalog #	Size, Blade Size
RT-465-01	31.5 cm (12 1/2"), 137 x 44 mm
RT-465-02	33 cm (13"), 137 x 65 mm

Deaver Retractor

Fig. 1



Catalog #	Size, Blade Width
RT-471-01	18 cm (7"), 19 mm

Deaver Retractor

Fig. 2



Catalog #	Size, Blade Width
RT-471-02	21.5 cm (8 1/2"), 22 mm

Deaver Retractor

Fig. 3



Catalog #	Size, Blade Width
RT-471-03	25 cm (9 3/4"), 25 mm

Deaver Retractor

Fig. 4



Catalog #	Size, Blade Width
RT-471-04	31 cm (12 1/4"), 25 mm

Retractors
 Wundhaken, Wundhäkchen
 Separadores
 Ecarteurs
 Divaricatori

Deaver Retractor
 Fig. 5



Catalog #	Size, Blade Width
RT-471-05	33 cm (13"), 25 mm

Deaver Retractor
 Fig. 6



Catalog #	Size, Blade Width
RT-471-06	36 cm (14 1/4"), 25 mm

Deaver Retractor
 Fig. 7



Catalog #	Size, Blade Width
RT-471-07	30 cm (11 3/4"), 38 mm

Deaver Retractor
 Fig. 8



Catalog #	Size, Blade Width
RT-471-08	31 cm (12 1/4"), 50 mm

Deaver Retractor
 Fig. 9



Catalog #	Size, Blade Width
RT-471-09	31.5 cm (12 1/2"), 75 mm

Retractors
Wundhaken, Wundhäkchen
Separadores
Ecarteurs
Divaricatori

Deaver Retractor

With Hollow Handle, Fig. 4

Catalog #	Size, Blade Width
RT-475-04	31.5cm (12 1/2"), 25 mm



Deaver Retractor

With Hollow Handle, Fig. 7

Catalog #	Size, Blade Width
RT-475-07	31.5cm (12 1/2"), 38 mm



Deaver Retractor

With Hollow Handle, Fig. 8

Catalog #	Size, Blade Width
RT-475-08	31.5 cm (12 1/2"), 50 mm



Deaver Retractor

With Hollow Handle, Fig. 10

Catalog #	Size, Blade Width
RT-475-10	31.5cm (12 1/2"), 100 mm



Leriche Retractor

Catalog #	Size, Blade Width
RT-479-01	25.5cm (10"), 45 mm
RT-479-02	27.5cm (10 3/4"), 60 mm



Retractors, Atrium Retractors
 Wundhaken, Wundhäkchen, Atriumhaken
 Separadores, Separadores para atrio
 Ecarteurs, Ecarteurs pour atrium
 Divaricatori, Divaricatori per atrio

Kummel Retractor



Catalog #	Size, Blade Size
RT-479-03	28.5 cm (11 1/4"), 46 mm

Koerte Retractor



Catalog #	Size, Blade Size
RT-481-30	30 cm (11 3/4"), 46 mm

**Cooley Retractor
 Right**



Catalog #	Size, Blade Size
RT-485-01	25 cm (9 3/4"), 48 x 48 mm

**Cooley Retractor
 Right, Serrated**



Catalog #	Size, Blade Size, Profile
RT-485-02	25 cm (9 3/4"), 48 x 48 mm

**Cooley Retractor
 Left**



Catalog #	Size, Blade Size
RT-485-03	27 cm (10 3/4"), 30 x 48 mm

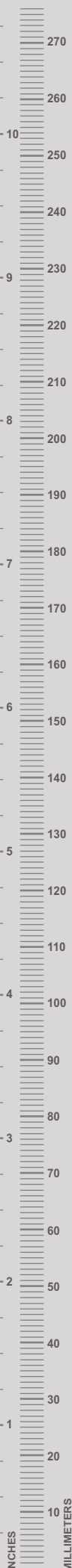

Retractors, Pelvis Retractors
 Wundhaken, Pelvishaken
 Separadores, Separadores para pelvis
 Ecarteurs, Ecarteurs pour pelvis
 Divaricatori, Divaricatori per pelvis

Mikulicz Liver Retractor

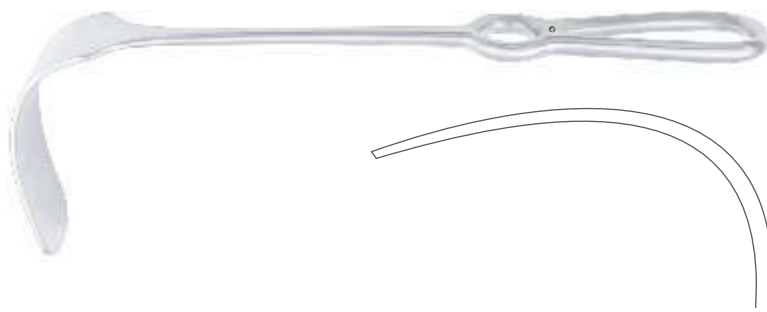

Catalog #	Size, Blade Size
RT-489-01	25 cm (9 3/4"), 90 x 35 mm
RT-489-02	25 cm (9 3/4"), 125 x 50 mm
RT-489-03	25 cm (9 3/4"), 160 x 50 mm

Mikulicz Retractor



Catalog #	Size, Blade Size
RT-491-26	26 cm (10 1/4"), 90 x 55 mm

Kelly Retractor

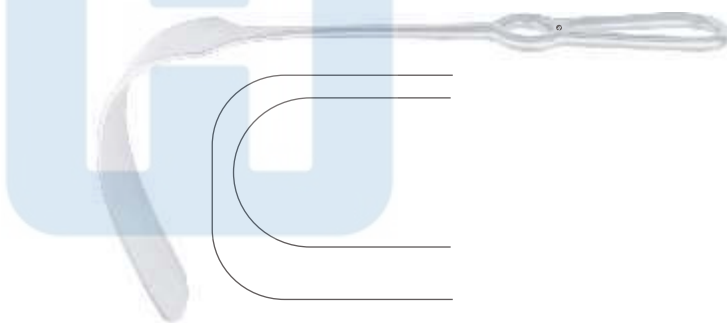

Catalog #	Size, Blade Size
RT-495-01	27.5 cm (10 3/4"), 205 x 38 mm
RT-495-02	27.5 cm (10 3/4"), 205 x 57 mm

St. Marks Pelvis Retractor

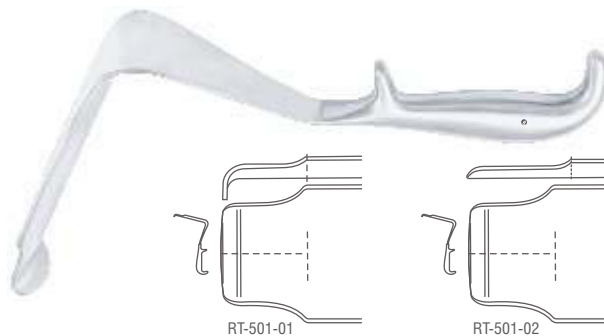

Catalog #	Size, Blade Size
RT-501-01	29 cm (11 1/2"), 142 x 60 mm - 35 x 45 mm
RT-501-02	29 cm (11 1/2"), 193 x 60 mm - 60 x 45 mm
RT-501-03	33 cm (13"), 195 x 60 mm - 60 x 45 mm

Kummel Abdominal Spatula



Catalog #	Size, Blade Width
RT-511-28	31 cm (12 1/4"), 45 mm

Abdominal Spatulas
 Bauchspatel
 Espátulas abdominales
 Spatules abdominales
 Spatole addominali

Kader Abdominal Spatula

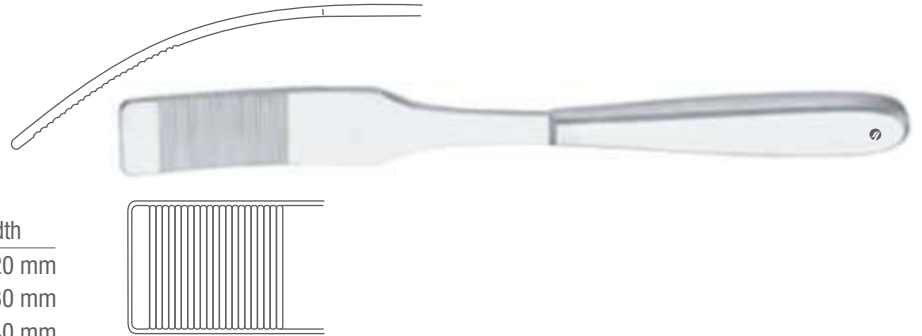

Catalog #	Size, Blade Width
RT-515-20	28 cm (11"), 20 mm
RT-515-30	28 cm (11"), 30 mm
RT-515-40	28 cm (11"), 40 mm

Abdominal Spatula

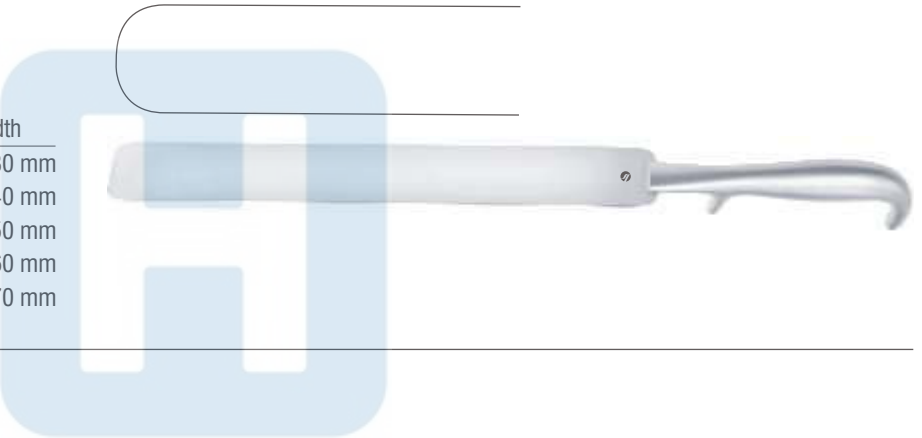

Catalog #	Size, Blade Width
RT-520-30	41 cm (16"), 30 mm
RT-520-40	41 cm (16"), 40 mm
RT-520-50	41 cm (16"), 50 mm
RT-520-60	41 cm (16"), 60 mm
RT-520-70	41 cm (16"), 70 mm

Reverdin Abdominal Spatula



Catalog #	Size, Blade Size
RT-523-28	28.5 cm (11 1/4"), 63 x 45 mm

Abdominal Spatula



Catalog #	Size, Blade Width
RT-530-20	33 cm (13"), 20 mm
RT-530-25	33 cm (13"), 25 mm
RT-530-30	33 cm (13"), 30 mm
RT-530-40	33 cm (13"), 40 mm
RT-530-50	33 cm (13"), 50 mm

Abdominal Spatulas, Retractors
 Bauchspatel, Wundhaken, Wundhäkchen
 Espátulas abdominales, Separadores
 Spatules abdominales, Ecarteurs
 Spatole addominali, Divaricatori

Tuffier Abdominal Spatula
 Tapered



Catalog #	Size, Blade Width
RT-534-20	20 cm (8"), 16 x 25 mm

Heberer Abdominal Spatula
 Tapered



Catalog #	Size, Blade Size
RT-536-01	28 cm (11"), 25 x 30 mm
RT-536-02	30 cm (11 3/4"), 37 x 45 mm
RT-536-03	30.5 cm (12"), 40 x 50 mm

Martin Abdominal Spatula
 Malleable, Very Soft



Catalog #	Size, Blade Width
RT-540-06	20 cm (8"), 6.5 mm
RT-540-09	20 cm (8"), 9.5 mm
RT-540-13	20 cm (8"), 13 mm
RT-540-16	20 cm (8"), 16 mm
RT-540-19	20 cm (8"), 19 mm
RT-540-25	20 cm (8"), 25 mm

Prostate Retractor



Catalog #	Size
RT-543-36	36 cm (14 1/4")

Urethral Retractor



Catalog #	Size
RT-545-39	39 cm (15 1/2")

Retractors
 Wundhaken, Wundhäkchen
 Separadores
 Ecarteurs
 Divaricatori

Collin-Hartmann Retractor

Catalog #	Size
RT-551-01	15 cm (6")

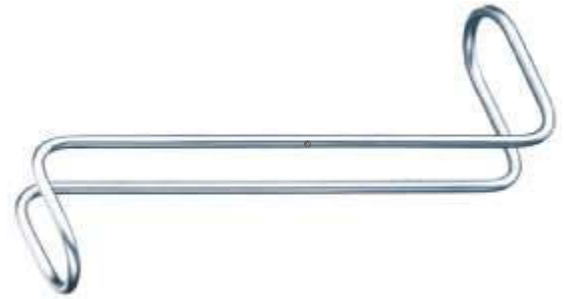

Sternberg Retractor

Catalog #	Size
RT-553-01	12 cm (4 3/4")
RT-553-02	13 cm (5")
RT-553-03	13.5 cm (5 1/4")

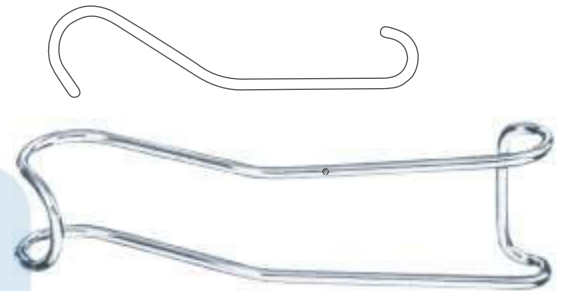

Roux-Mini Retractor

Catalog #	Size, Blade Width
RT-557-14	14.5 cm (5 3/4"), 6 x 7 mm - 7 x 8 mm

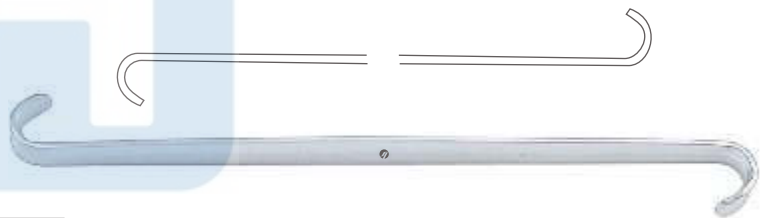

Roux-Baby Retractor

Catalog #	Size, Blade Width
RT-559-12	12.5 cm (5"), 17 x 17 mm - 24 x 21 mm

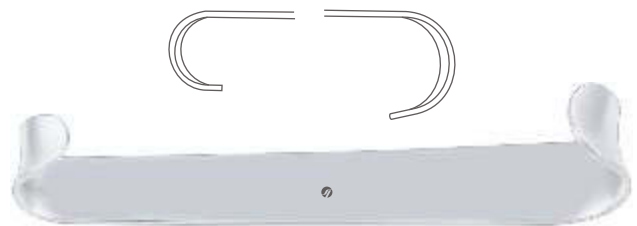

Roux Retractor

Set of Fig. 1, Fig. 2 and Fig. 3

Catalog #	Size
RT-561-00	N/A

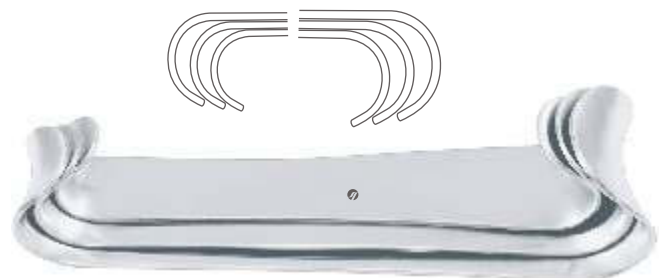

Retractors
Wundhaken, Wundhäkchen
Separadores
Ecarteurs
Divaricatori

Roux Retractor

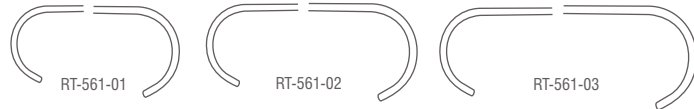

Catalog #	Size, Profile
RT-561-01	14 cm (5 1/2"), Fig. 1
RT-561-02	15 cm (6"), Fig. 2
RT-561-03	17 cm (6 3/4"), Fig. 3

Farabeuf Retractor

Set of Fig. 1 and Fig. 2



Catalog #	Size, Blade Size Fig. 1, Blade Size Fig. 2
RT-565-00	12 cm (4 3/4"), 26 x 10 mm - 30 x 13 mm, 30 x 10 mm - 34 x 13 mm

Farabeuf Retractor

Set of Fig. 1 and Fig. 2



Catalog #	Size, Blade Size Fig. 1, Blade Size Fig. 2
RT-567-00	15 cm (6"), 23 x 16 mm - 26 x 16 mm, 27 x 16 mm - 30 x 16 mm

Parker Retractor

Set of Fig. 1 and Fig. 2



Catalog #	Size, Blade Size Fig. 1, Blade Size Fig. 2
RT-571-01	13.5 cm (5 1/4"), 19 x 15 mm - 19 x 15 mm, 22 x 15 mm - 22 x 15 mm
RT-571-02	17.5 cm (7"), 26 x 25 mm - 27 x 25 mm, 29 x 25 mm - 27 x 25 mm

Parker-Mott Retractor

Set of Fig. 1 and Fig. 2



Catalog #	Size, Blade Size Fig. 1, Blade Size Fig. 2
RT-573-16	16 cm (6 1/4"), 21 x 24 mm - 68 x 24 mm, 25 x 24 mm - 72 x 24 mm

Retractors
Wundhaken, Wundhäkchen
Separadores
Ecarteurs
Divaricatori

Mathieu Retractor
Set of Fig. 1 and Fig. 2

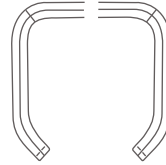

Catalog #	Size, Blade Size Fig. 1, Blade Size Fig. 2
RT-577-20	20 cm (8"), 42 x 13 mm - 42 x 26 mm / 47 x 13 mm - 46 x 26 mm

Parker-Langenbeck (US Army) Retractor
Set of Fig. 1 and Fig. 2

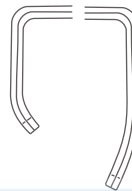

Catalog #	Size, Blade Size Fig. 1, Blade Size Fig. 2
RT-579-21	21.5 cm (8 1/2"), 21 x 15 mm - 40 x 15 mm / 25 x 15 mm - 45 x 15 mm

Hajek Retractor

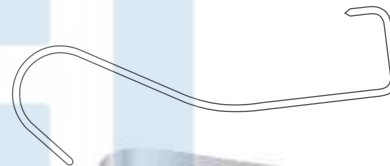

Catalog #	Size, Blade Size
RT-581-16	16.5 cm (6 1/2"), 30 x 18 mm - 25 x 10 mm

Lane Retractor



Catalog #	Size, Blade Width
RT-583-01	23 cm (9"), 30 x 13 mm - 35 x 19 mm
RT-583-02	23 cm (9"), 30 x 25 mm - 35 x 32 mm

Czerny Retractor



Catalog #	Size, Blade Width
RT-591-17	17.5 cm (7"), 38 x 22 mm - 38 x 22 mm

Retractors
Wundhaken, Wundhäkchen
Separadores
Ecarteurs
Divaricatori

Goelet Retractor

Catalog #	Size, Blade Width
RT-593-19	19 cm (7 1/2"), 40 x 40 mm - 30 x 30 mm

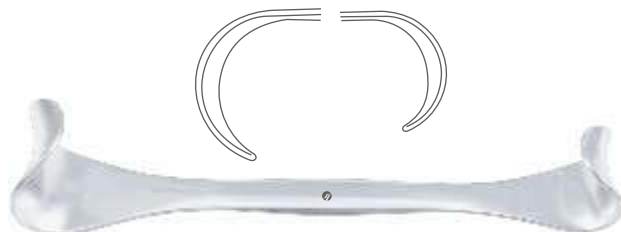

Cranny-Ryall Retractor

Catalog #	Size, Blade Width
RT-595-01	19 cm (7 1/2"), 16 mm
RT-595-02	19 cm (7 1/2"), 20 mm
RT-595-03	20 cm (8"), 25 mm

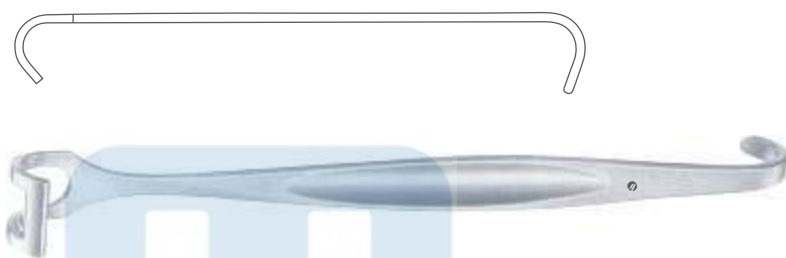

Finsen Wound Spreader

2 x 3 Sharp Prongs

Catalog #	Size
RT-650-05	5 cm (2")



Finsen Wound Spreader

2 x 3 Blunt Prongs

Catalog #	Size
RT-651-05	5 cm (2")



Finsen Wound Spreader

3 x 4 Sharp Prongs

Catalog #	Size
RT-652-07	7 cm (2 3/4")



Wound Spreaders, Self-Retaining
 Wundspreizer
 Separadores autoestáticos
 Ecarteurs autostatiques
 Divaricatori autostatici

Finsen Wound Spreader
 3 x 4 Blunt Prongs

Catalog #	Size
RT-653-07	7 cm (2 3/4")



Finsen-Martin Wound Spreader
 3 x 4 Sharp Prongs, With Adjustment Screw

Catalog #	Size
RT-654-07	7 cm (2 3/4")



Finsen-Martin Wound Spreader
 3 x 4 Blunt Prongs, With Adjustment Screw

Catalog #	Size
RT-655-07	7 cm (2 3/4")



Logan Wound Spreader
 3 x 3 Sharp - With Adjustment Screw

Catalog #	Size
RT-658-04	4 cm (1 1/2")



Bose Fat Spreader for Coronary Surgery

Catalog #	Size
RT-661-30	3 cm (1 1/4")



Wound Spreaders, Self-Retaining
 Wundspreizer
 Separadores autoestáticos
 Ecarteurs autostatiques
 Divaricatori autostatici

Fat Spreader for Coronary Surgery

Catalog #	Size
RT-663-40	4 cm (1 1/2")
RT-663-50	5.5 cm (2 1/4")



Buckley Wound Spreader 3 x 3 Sharp Prongs

Catalog #	Size
RT-666-06	6 cm (2 1/4")



Alm Wound Spreader 4 x 4 Sharp Prongs

Catalog #	Size
RT-668-07	7 cm (2 3/4")
RT-668-10	10 cm (4")



Alm Wound Spreader 4 x 4 Blunt Prongs

Catalog #	Size
RT-669-07	7 cm (2 3/4")
RT-669-10	10 cm (4")



Allport Wound Spreader 4 x 4 Sharp Prongs

Catalog #	Size
RT-672-10	9.5 cm (3 3/4")



Wound Spreaders, Self-Retaining
 Wundspreizer
 Separadores autoestáticos
 Ecarteurs autostatiques
 Divaricatori autostatici

Wound Spreader
 4 x 4 Sharp Prongs



Catalog #	Size
RT-674-10	10 cm (4")

Wound Spreader
 4 x 4 Blunt Prongs



Catalog #	Size
RT-675-10	10 cm (4")

Jansen Self Retaining Retractor
 3 x 3 Blunt Prongs, With Adjustment Screw

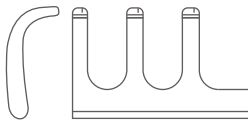

Catalog #	Size
RT-677-10	10 cm (4")

Scalp-Contour Self Retaining Retractor
 3 x 4 Sharp Prongs

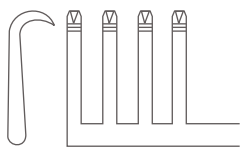

Catalog #	Size
RT-680-13	13.5 cm (5 1/4")

Wound Spreaders, Self-Retaining
 Wundspreizer
 Separadores autoestáticos
 Ecarteurs autostatiques
 Divaricatori autostatici

Scalp-Contour Self Retaining Retractor
 3 x 4 Blunt Prongs

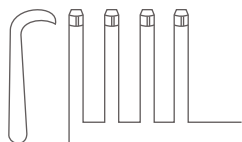

Catalog #	Size
RT-681-13	13.5 cm (5 1/4")

Anderson-Adson Self Retaining Retractor
 4 x 4 Sharp Prongs

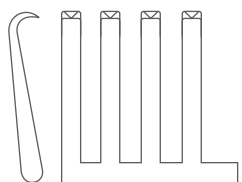

Catalog #	Size
RT-686-20	20 cm (8")

Anderson-Adson Self Retaining Retractor
 4 x 4 Blunt Prongs

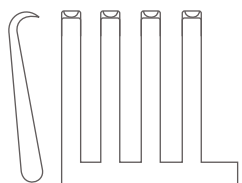

Catalog #	Size
RT-687-20	20 cm(8")

Wound Spreaders, Self-Retaining
 Wundspreizer
 Separadores autoestáticos
 Ecarteurs autostatiques
 Divaricatori autostatici

Traverse Self Retaining Retractor
 4 x 5 Blunt Prongs



Catalog #	Size
RT-689-21	21.5 cm (8 1/2")

Norfolk-Norwich Self Retaining Retractor
 4 x 5 Blunt Prongs

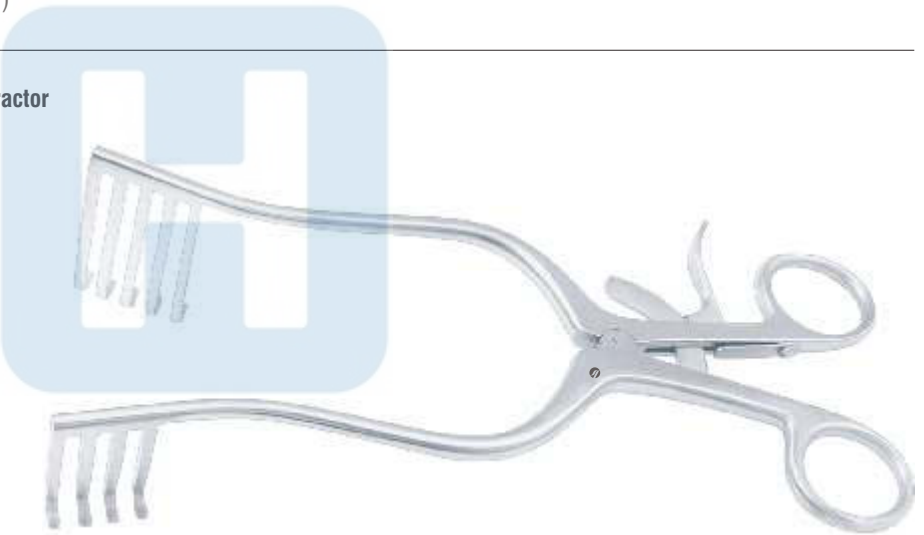
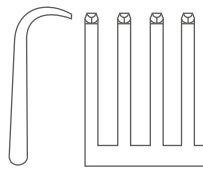

Catalog #	Size
RT-691-22	22 cm (8 3/4")

Weitlaner Self Retaining Retractor
 3 x 4 Sharp Prongs

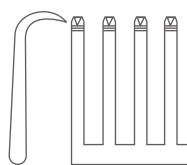

Catalog #	Size
RT-696-20	20 cm (8")

Wound Spreaders, Self-Retaining
Wundspreizer
Separadores autoestáticos
Ecarteurs autostatiques
Divaricatori autostatici

Weitlaner Self Retaining Retractor
3 x 4 Blunt Prongs

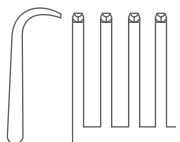

Catalog #	Size
RT-697-20	20 cm (8")

Adson Self Retaining Retractor
3 x 4 Sharp Prongs

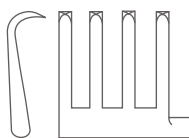

Catalog #	Size
RT-700-26	26 cm (10 1/4")

Adson Self Retaining Retractor
3 x 4 Blunt Prongs

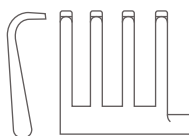

Catalog #	Size
RT-701-26	26 cm (10 1/4")

Wound Spreaders, Self-Retaining
 Wundspreizer
 Separadores autoestáticos
 Ecarteurs autostatiques
 Divaricatori autostatici

Adson Self Retaining Retractor
 6 x 6 Sharp Prongs

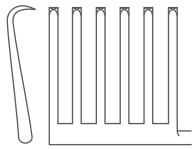

Catalog #	Size
RT-702-26	29 cm (11 1/2")

Adson Self Retaining Retractor
 6 x 6 Blunt Prongs

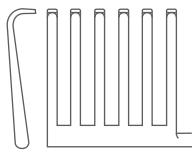

Catalog #	Size
RT-703-26	29 cm (11 1/2")

Weitlaner Self Retaining Retractor
 2 x 3 Sharp Prongs

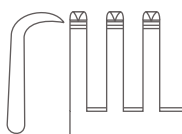

Catalog #	Size
RT-710-11	11 cm (4 1/4")

Wound Spreaders, Self-Retaining
 Wundspreizer
 Separadores autoestáticos
 Ecarteurs autostatiques
 Divaricatori autostatici

Weitlaner Self Retaining Retractor
 2 x 3 Blunt Prongs

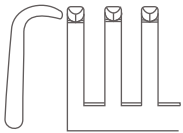

Catalog #	Size
RT-711-11	11 cm (4 1/4")

Weitlaner Self Retaining Retractor
 3 x 4 Sharp Prongs

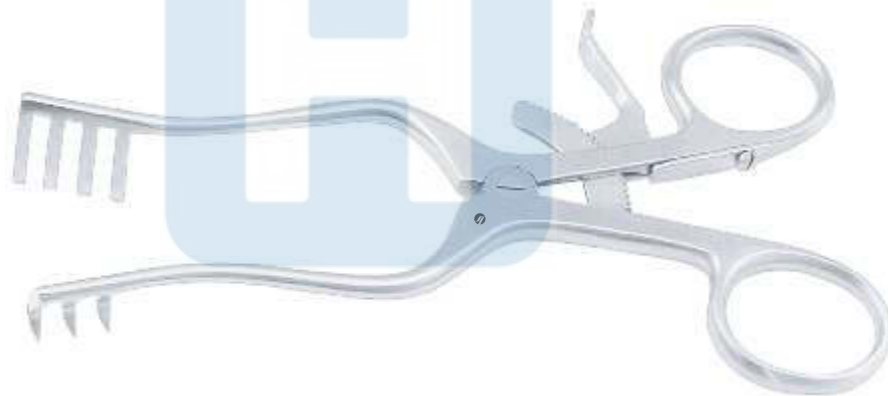
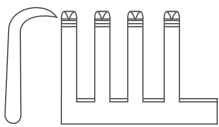

Catalog #	Size
RT-712-13	13.5 cm (5 1/4")
RT-712-16	16 cm (6 1/4")

Weitlaner Self Retaining Retractor
 3 x 4 Blunt Prongs

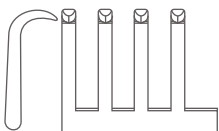

Catalog #	Size
RT-713-13	13.5 cm (5 1/4")
RT-713-16	16 cm (6 1/4")

Wound Spreaders, Self-Retaining
 Wundspreizer
 Separadores autoestáticos
 Ecarteurs autostatiques
 Divaricatori autostatici

Weitlaner-Wullstein Self Retaining Retractor
 3 x 3 Sharp Prongs

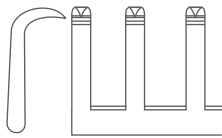

Catalog #	Size
RT-716-13	13 cm (5")

Weitlaner-Wullstein Self Retaining Retractor
 3 x 3 Blunt Prongs

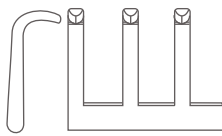

Catalog #	Size
RT-717-13	13 cm (5")

Perkins Self Retaining Retractor

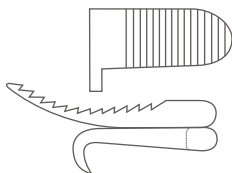

Catalog #	Size, Profile
RT-721-01	13 cm (5"), Right

Wound Spreaders, Self-Retaining
 Wundspreizer
 Separadores autoestáticos
 Ecarteurs autostatiques
 Divaricatori autostatici

Perkins Self Retaining Retractor

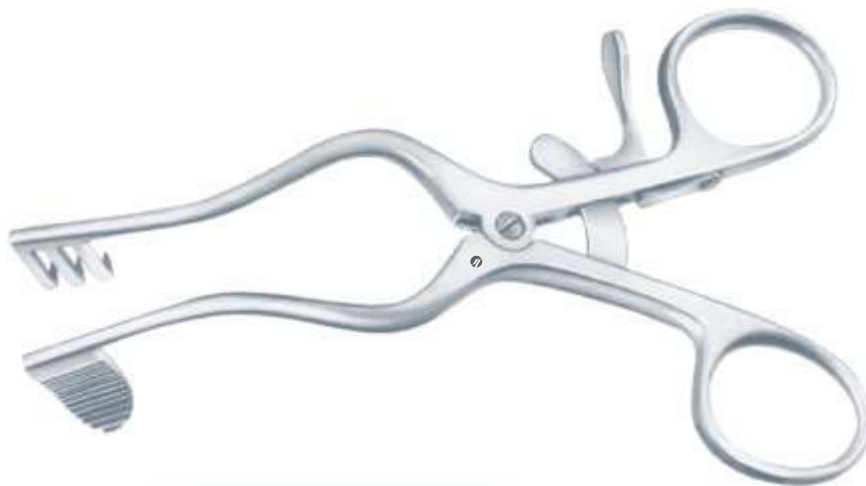
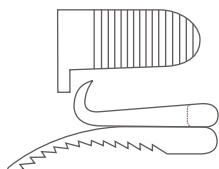

Catalog #	Size, Profile
RT-721-02	13 cm (5"), Left

Jefferson Self Retaining Retractor
 2 x 3 Blunt Prongs

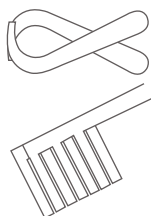

Catalog #	Size
RT-725-14	14 cm (5 1/2")

Mollison Self Retaining Retractor
 2 x 2 Sharp Prongs



Catalog #	Size
RT-728-14	14 cm (5 1/2")

Wound Spreaders, Self-Retaining
 Wundspreizer
 Separadores autoestáticos
 Ecarteurs autostatiques
 Divaricatori autostatici

Mollison Self Retaining Retractor
 4 x 4 Sharp Prongs

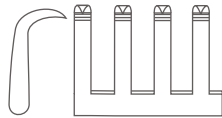

Catalog #	Size
RT-730-15	15.5 cm (6")

Plester Self Retaining Retractor
 2 x 2 Sharp Prongs

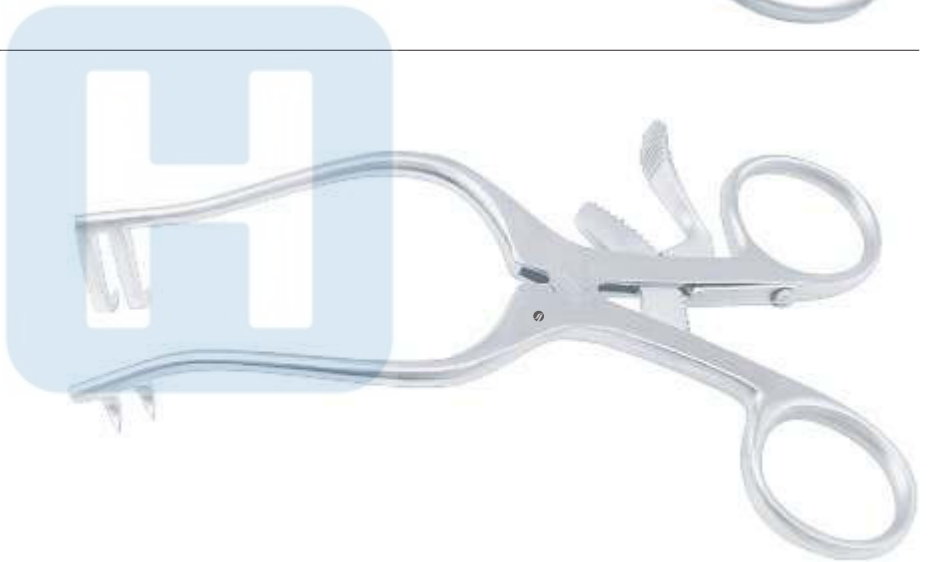
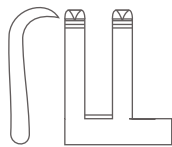

Catalog #	Size
RT-732-13	13 cm (5")

Plester Self Retaining Retractor
 2 x 2 Blunt Prongs

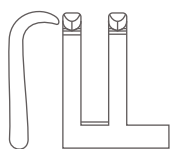

Catalog #	Size
RT-733-13	13 cm (5")

Wound Spreaders, Self-Retaining
 Wundspreizer
 Separadores autoestáticos
 Ecarteurs autostatiques
 Divaricatori autostatici

Plester Self Retaining Retractor

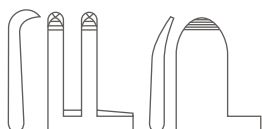

Catalog #	Size, Profile
RT-735-01	10.5 cm (4"), Left
RT-735-02	10.5 cm (4"), Right

Milligan Self Retaining Retractor

3 x 3 Blunt Prongs

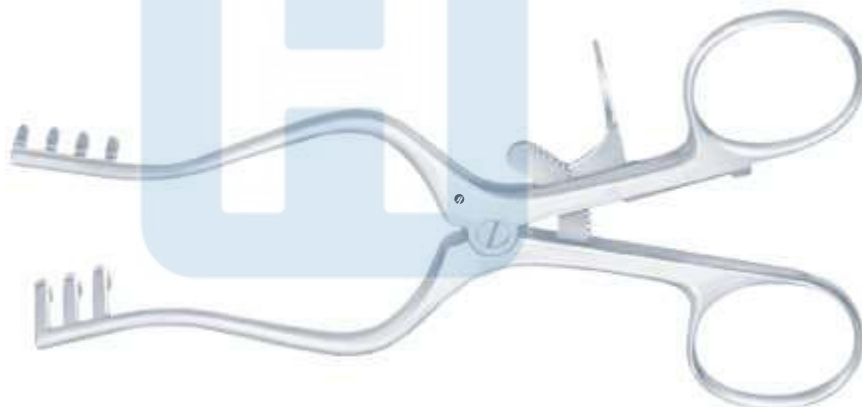
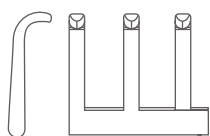

Catalog #	Size
RT-737-13	13.5 cm (5 1/4")

Weitlaner-Baby Self Retaining Retractor

Blunt

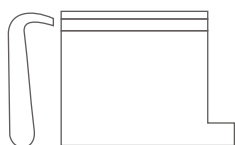

Catalog #	Size
RT-739-13	13.5 cm (5 1/4")

Wound Spreaders, Self-Retaining
 Wundspreizer
 Separadores autoestáticos
 Ecarteurs autostatiques
 Divaricatori autostatici

Adson Self Retaining Retractor
 3 x 4 Sharp Prongs

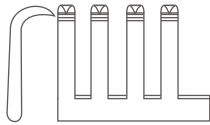

Catalog #	Size
RT-742-13	14 cm (5 1/2")
RT-742-16	16.5 cm (6 1/2")
RT-742-21	21 cm (8 1/4")
RT-742-24	24.5 cm (9 3/4")



Adson Self Retaining Retractor
 3 x 4 Blunt Prongs

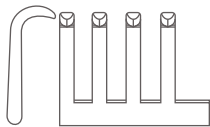

Catalog #	Size
RT-743-13	14 cm (5 1/2")
RT-743-16	16.5 cm (6 1/2")
RT-743-21	21 cm (8 1/4")
RT-743-24	24.5 cm (9 3/4")

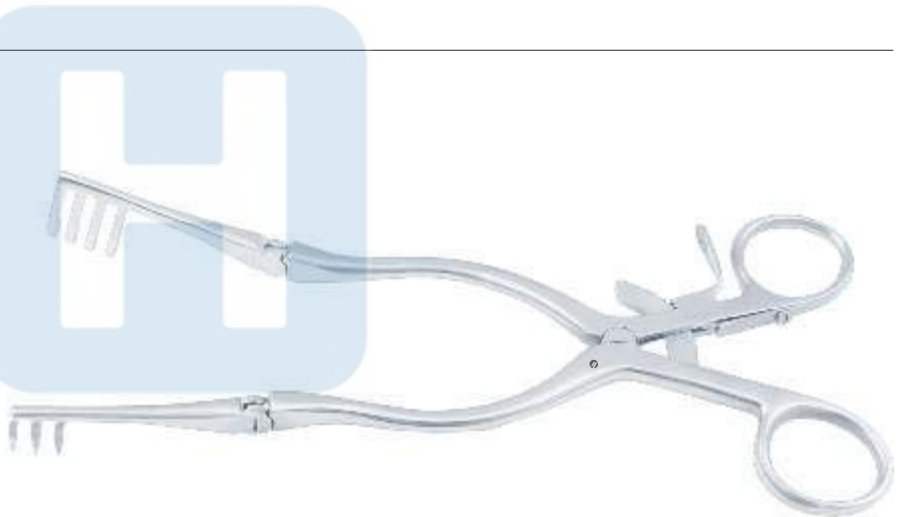

Beckmann Self Retaining Retractor
 4 x 4 Sharp Prongs

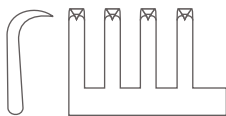

Catalog #	Size
RT-750-32	32 cm (12 1/2")



Abdominal Retractors
Bauchdeckenhalter
Separadores abdominales
Ecarteurs abdominaux
Divaricatori addominali

Adson Self Retaining Retractor
4 x 5 Blunt Prongs

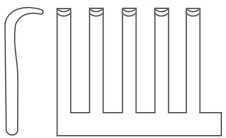

Catalog #	Size
RT-753-33	33 cm (13")

Harvey-Jackson Self Retaining Retractor
3 x 3 Sharp Prongs

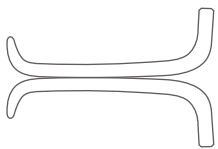

Catalog #	Size
RT-758-28	28 cm (11")

Beckmann-Adson Self Retaining Retractor
4 x 4 Short Sharp Prongs

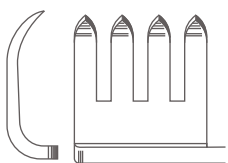

Catalog #	Size
RT-760-30	30.5 cm (12")

Wound Spreaders, self-retaining
 Wundspreizer
 Separadores autoestáticos
 Ecarteurs autostatiques
 Divaricatori autostatici

Beckmann-Adson Self Retaining Retractor
 4 x 4 Short Blunt Prongs

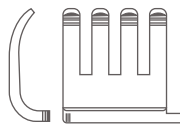

Catalog #	Size
RT-761-30	30.5 cm (12")

Beckmann-Adson Self Retaining Retractor
 4 x 4 Long Sharp Prongs

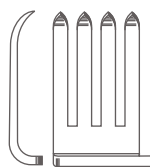

Catalog #	Size
RT-762-30	30.5 cm (12")

Beckmann-Adson Self Retaining Retractor
 4 x 4 Long Blunt Prongs

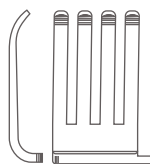

Catalog #	Size
RT-763-30	30.5 cm (12")

Wound Spreaders, self-retaining
 Wundspreizer
 Separadores autoestáticos
 Ecarteurs autostatiques
 Divaricatori autostatici

Beckmann-Eaton Self Retaining Retractor
 7 x 7 Sharp Prongs

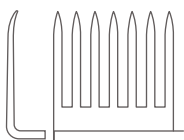

Catalog #	Size
RT-766-32	32 cm (12 1/2")

Martin Self Retaining Retractor
 6 x 6 Sharp Long Prongs

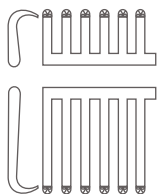

Catalog #	Size, Profile
RT-770-01	28.5 cm (11 1/4"), Teeth on Left Side
RT-770-02	28.5 cm (11 1/4"), Teeth on Right Side

Joll (Friedman) Self Retaining Retractor
 Thyroid and Vaginal Retractor



Catalog #	Size
RT-801-15	15.5 cm (6")

Wound Spreaders, self-retaining
 Wundspreizer
 Separadores autoestáticos
 Ecarteurs autostatiques
 Divaricatori autostatici

Gelpi Self Retaining Retractor



Catalog #	Size
RT-805-13	13 cm (5")
RT-805-15	15 cm (6")
RT-805-18	18.5 cm (7 1/4")

Gelpi Self Retaining Retractor



Catalog #	Size
RT-807-10	10 cm (4")
RT-807-14	14.5 cm (5 3/4")
RT-807-18	18 cm (7")

Gelpi Self Retaining Retractor



Catalog #	Size
RT-811-18	18.5 cm (7 1/4")

Wound Spreaders, self-retaining
Wundspreizer
Separadores autoestáticos
Ecarteurs autostatiques
Divaricatori autostatici

Jackson-Burrows Self Retaining Retractor

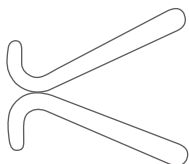

Catalog #	Size
RT-813-18	18.5 cm (7 1/4")

Collin-Baby Retractor Complete

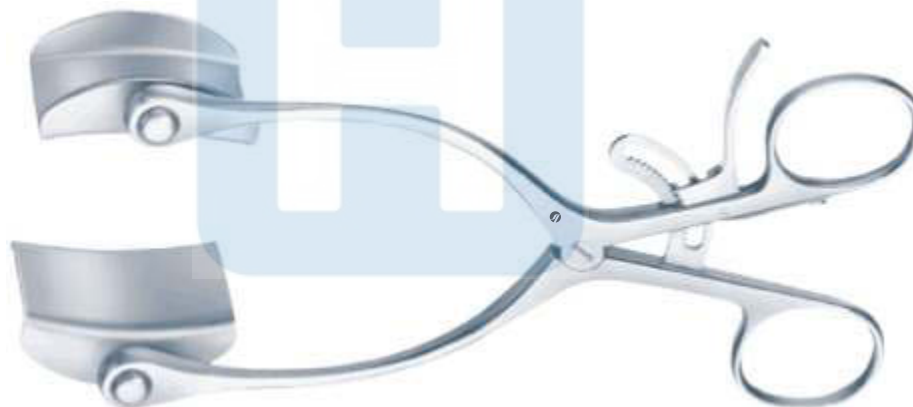

Catalog #	Size
RT-820-00	20 cm (8")

Collin Retractor Complete

With Pair of Lateral Blades Ref: RT-835-38



Catalog #	Size
RT-822-00	Standard

Abdominal Retractors
 Bauchdeckenhalter
 Separadores abdominales
 Ecarteurs abdominaux
 Divaricatori addominali

Collin Retractor Only
 Without Blade



Catalog #	Size
RT-822-01	24 cm (9 1/2")

Collin Retractor Complete
 With Central Blades Ref: RT-823-90 and 1 Pair of
 Lateral Blades Ref: RT-835-38



Catalog #	Size
RT-823-00	Standard

Collin Retractor Only
 Without Blades



Catalog #	Size
RT-823-01	22.5 cm (8 3/4")

Abdominal Retractors
Bauchdeckenhalter
Separadores abdominales
Ecarteurs abdominaux
Divaricatori addominali

Collin Central Blade

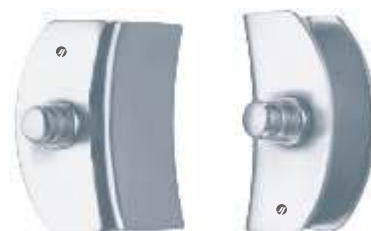

Catalog #	Blade Size
RT-823-90	38 x 55 mm

Collin Retractor Complete

With Central Blade Ref:- RT-824-90 and 1 Pair of Lateral Blades Ref:- RT-835-45

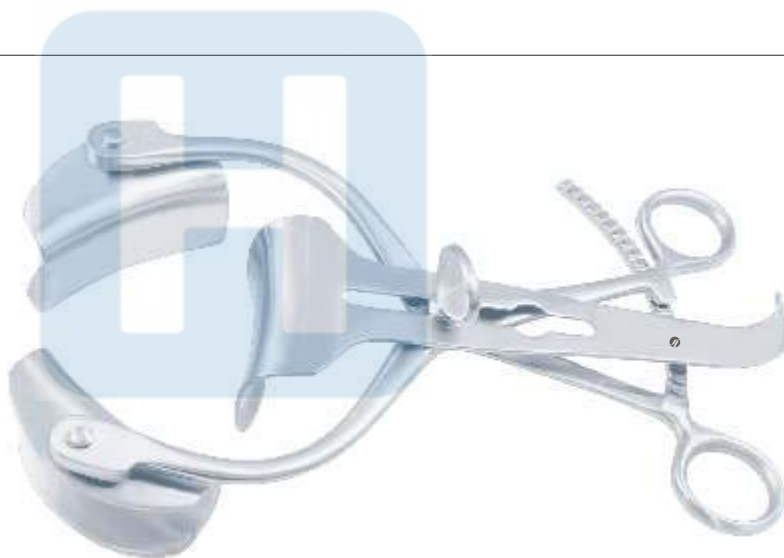

Catalog #	Size
RT-824-00	22.5 cm (8 ¾")

Collin Central Blade



Catalog #	Blade Size
RT-824-90	50 x 75 mm

Abdominal Retractors
 Bauchdeckenhalter
 Separadores abdominales
 Ecarteurs abdominaux
 Divaricatori addominali

Collin Retractor Complete

With Central Blade Ref:- RT-826-90 and 1 Pair of
 Lateral Blades Ref:- RT-835-60



Catalog #	Size
RT-826-00	Standard

**Collin Retractor Only
 Without Blades**



Catalog #	Size
RT-826-01	31 cm (12 1/4")

Collin Central Blade



Catalog #	Blade Size
RT-826-90	60 x 75 mm

Abdominal Retractors
Bauchdeckenhalter
Separadores abdominales
Ecarteurs abdominaux
Divaricatori addominali

Ricard Retractor Complete

With Central Blade Ref:- RT-830-02 and 1 Pair of Lateral Blades Ref:- RT-835-90



Catalog #	Size
RT-830-00	Standard

Ricard Retractor Only

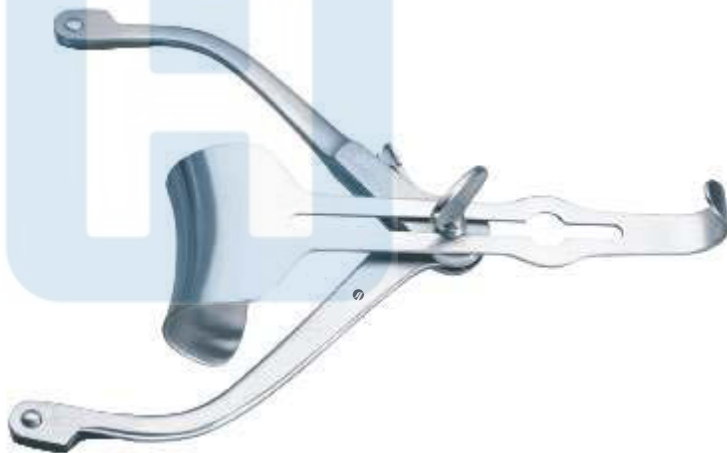

Catalog #	Size
RT-830-01	Standard

Collin Central Blade



Catalog #	Blade Size
RT-830-02	55 x 70 mm

Abdominal Retractors
 Bauchdeckenhalter
 Separadores abdominales
 Ecarteurs abdominaux
 Divaricatori addominali

Ricard Retractor Complete

With Central Blade Ref:- RT-832-02 and 1 Pair of Lateral Blades Ref:- RT-835-92



Catalog #	Size
RT-832-00	Standard

Ricard Central Blade



Catalog #	Blade Size
RT-832-02	80 x 90 mm

Ricard Central Blade

Catalog #	Blade Size
RT-835-18	18 x 40 mm
RT-835-27	27 x 40 mm
RT-835-38	38 x 60 mm
RT-835-40	40 x 80 mm
RT-835-45	45 x 80 mm
RT-835-50	50 x 70 mm
RT-835-52	52 x 110 mm
RT-835-60	60 x 80 mm
RT-835-70	70 x 55 mm
RT-835-80	75 x 90 mm
RT-835-90	50 x 58 mm
RT-835-92	60 x 80 mm
RT-835-94	72 x 85 mm

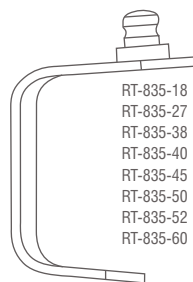

RT-835-18
 RT-835-27
 RT-835-38
 RT-835-40
 RT-835-45
 RT-835-50
 RT-835-52
 RT-835-60

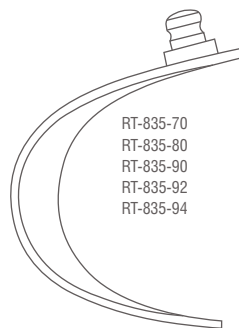

RT-835-70
 RT-835-80
 RT-835-90
 RT-835-92
 RT-835-94



Abdominal Retractors
Bauchdeckenhalter
Separadores abdominales
Ecarteurs abdominaux
Divaricatori addominali

Henley Retractor Complete

3 x 4 Sharp Prongs, With 3 Central Blades Ref:- RT-840-19, RT-840-25 and RT-840-32

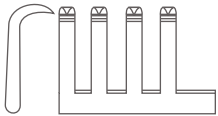

Catalog #	Size
RT-840-01	16 cm (6 1/4")

Henley Retractor Complete

3 x 4 Blunt Prongs, With 3 Central Blades Ref:- RT-840-19, RT-840-25 and RT-840-32

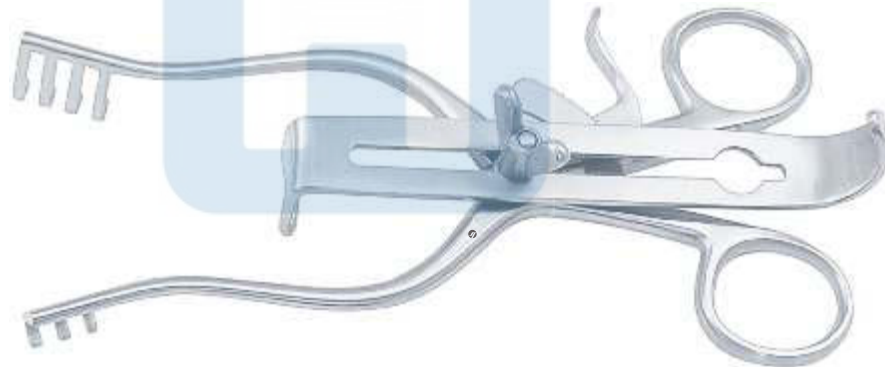
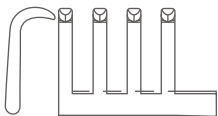

Catalog #	Size
RT-840-02	16 cm (6 1/4")

Henley Central Blade

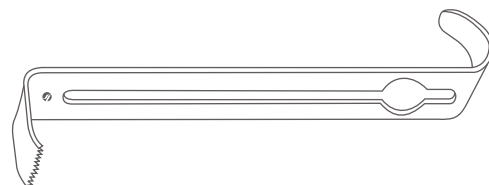

Catalog #	Blade Size
RT-840-19	19 x 17 mm
RT-840-25	25 x 17 mm
RT-840-32	32 x 17 mm

Abdominal Retractors
 Bauchdeckenhalter
 Separadores abdominales
 Ecarteurs abdominaux
 Divaricatori addominali

Millin Retractor Complete

With Central Blade Ref:- RT-850-90, 1 Pair Each of
 Lateral Blades Ref:- RT-851-57 and Ref:- RT-851-82



Catalog #	Size
RT-850-00	Standard

Millin Retractor Only



Catalog #	Size
RT-850-01	Standard

Millin Central Blade Only



Catalog #	Blade Size
RT-850-90	105 x 45 mm

Abdominal Retractors
Bauchdeckenhalter
Separadores abdominales
Ecarteurs abdominaux
Divaricatori addominali

Millin Lateral Blade

Catalog #	Blade Size
RT-851-57	57 x 25 mm
RT-851-82	82 x 25 mm



Lagueu Retractor

Catalog #	Size, Blade Size
RT-853-26	26 cm (10 1/4"), 90 x 35 mm



Millin Retractor

Catalog #	Size, Spread
RT-855-28	28 cm (11"), 70 mm



Judd-Masson Retractor

Catalog #	Spread
RT-858-00	120 mm



Abdominal Retractors
 Bauchdeckenhalter
 Separadores abdominales
 Ecarteurs abdominaux
 Divaricatori addominali

Vickers Low-Profile Retractor Complete

2 x 2 Blunt Prongs, With Central Blade Ref:- RT-801-01

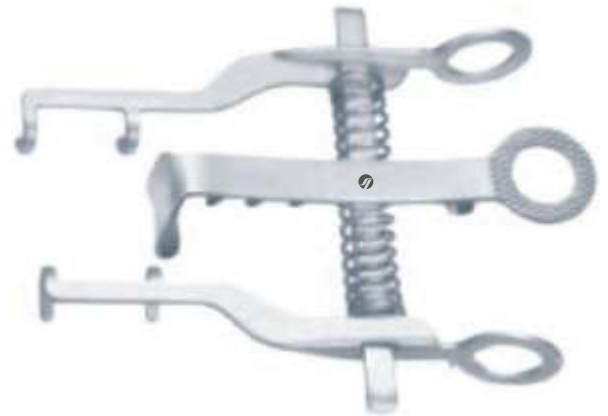
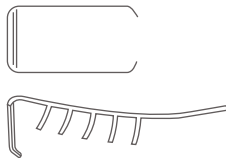

Catalog #	Size
RT-861-00	7.5 cm (3")

Vickers Low-Profile Central Blade

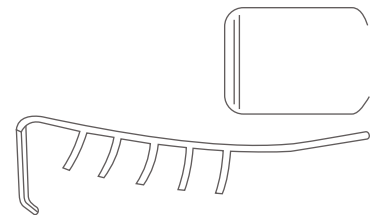

Catalog #	Blade Size
RT-861-01	10 x 18 mm
RT-861-02	12 x 10 mm

Vickers Low-Profile Retractor Complete

3 x 3 Blunt Prongs, With Central Blade Ref:- RT-861-01



Catalog #	Size
RT-863-00	9 cm (3 1/2")

Abdominal Retractors
Bauchdeckenhalter
Separadores abdominales
Ecarteurs abdominaux
Divaricatori addominali

Vickers Low-Profile Retractor Complete
With Central Blade Ref:- RT-861-01

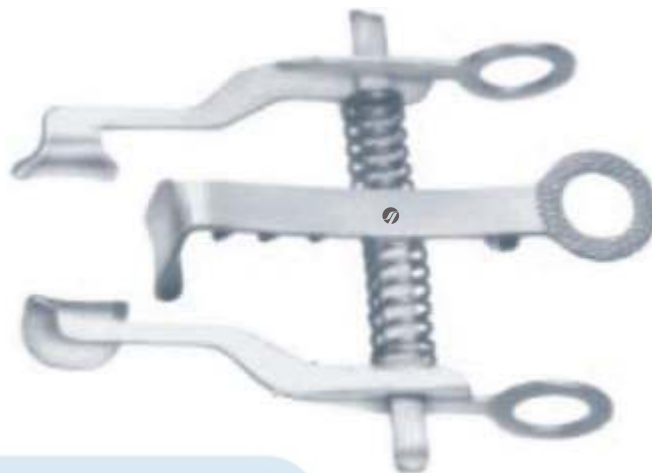

Catalog #	Size
RT-865-00	7.5 cm (3")

Vickers Self Retaining Retractor
Blunt Ring Model For Thumb And Fingers



Catalog #	Size
RT-869-00	5 cm (2")

Gosset-Baby Retractor



Catalog #	Size, Spread, Lateral Blades Size
RT-880-00	12.5 cm(5"), 120 mm, 40 x 30 mm

Abdominal Retractors
 Bauchdeckenhalter
 Separadores abdominales
 Ecarteurs abdominaux
 Divaricatori addominali

Gosset Retractor Complete

With Central Blade Ref:- RT-884-90



Catalog #	Size, Spread, Lateral Blades Size
RT-884-00	16.5 cm (6 1/2"), 160 mm, 63 x 35 mm

Gosset Central Blade



Catalog #	Blade Size
RT-884-90	60 x 56 mm

Gosset Retractor



Catalog #	Size
RT-886-00	18.5 cm (7 1/4")

Abdominal Retractors
Bauchdeckenhalter
Separadores abdominales
Ecarteurs abdominaux
Divaricatori addominali

Balfour-Baby Retractor Complete
With Central Blade Ref:- RT-890-90



Catalog #	Size, Spread
RT-890-00	12.5 cm (5"), 95 mm

Balfour-Baby Central Blade



Catalog #	Blade Size
RT-890-90	24 x 20 mm

Balfour Retractor Complete
With Central Blade Ref:- RT-903-01



Catalog #	Size, Spread, Lateral Blades Size
RT-892-00	20 cm (8"), 180 mm, 70 x 35 mm

Abdominal Retractors
 Bauchdeckenhalter
 Separadores abdominales
 Ecarteurs abdominaux
 Divaricatori addominali

Balfour Retractor Complete
 With Central Blade Ref:- RT-903-01



Catalog #	Size, Spread, Lateral Blades Size
RT-894-00	20 cm (8"), 180 mm, 70 x 35 mm

Balfour Retractor Complete
 With Central Blade Ref:- RT-903-01

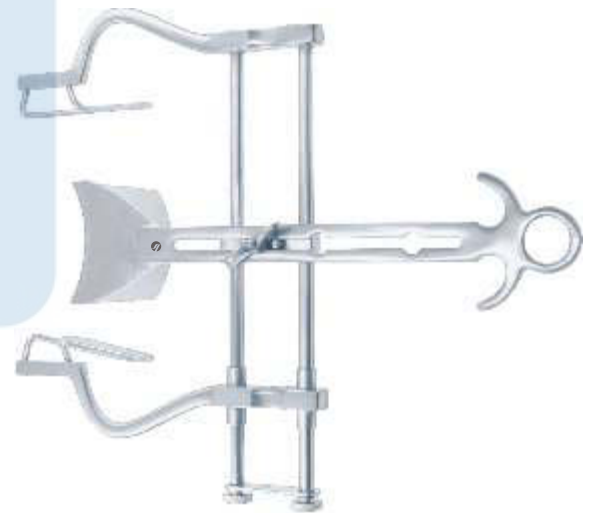

Catalog #	Size, Spread, Lateral Blades Size
RT-896-00	20 cm (8"), 200 mm, 100 x 35 mm

Balfour-Standard Retractor Complete
 With Central Blade Ref:- RT-903-02



Catalog #	Size, Spread, Lateral Blades Size
RT-898-00	20 cm (8"), 250 mm, 100 x 35 mm

Abdominal Retractors
Bauchdeckenhalter
Separadores abdominales
Ecarteurs abdominaux
Divaricatori addominali

Balfour Central Blade Retractor

Catalog #	Blades Size
RT-901-90	100 x 70 mm
RT-901-91	100 x 60 mm



Balfour Central Blade

Catalog #	Blade Size
RT-903-01	40 x 80 mm
RT-903-02	68 x 85 mm
RT-903-03	40 x 68 mm

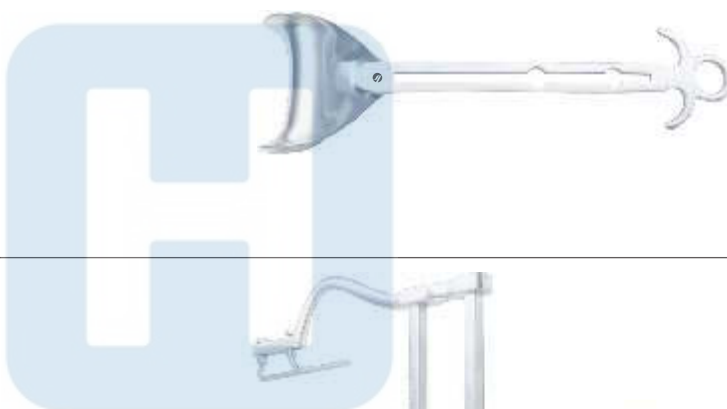

Balfour-Modell USA Retractor Complete

With 1 Pair Each of Lateral Blades Ref.- RT-906-06 and RT-906-08 and Central Blade RT-903-02

Catalog #	Spread
RT-906-00	190 mm



Balfour-Modell USA Lateral Blade

Catalog #	Blade Depth
RT-906-06	60 mm Deep
RT-906-08	80 mm Deep



Abdominal Retractors
 Bauchdeckenhalter
 Separadores abdominales
 Ecarteurs abdominaux
 Divaricatori addominali

Goligher Retractor Complete

With Central Blades Ref:- RT-910-90 and RT-910-91



Catalog #	Spread
RT-910-00	185 mm

Goligher Lateral Blade

Catalog #	Blade Depth
RT-910-05	51 mm Deep
RT-910-10	102 mm Deep



Goligher Central Blade

Catalog #	Blade Depth
RT-910-90	51 mm Deep
RT-910-91	102 mm Deep



Abdominal Retractors
 Bauchdeckenhalter
 Separadores abdominales
 Ecarteurs abdominaux
 Divaricatori addominali

Charnley Retractor Complete



Catalog #	Size
RT-914-00	Standard

O'Sullivan-O'Connor Retractor Complete

With 2 Fixed Blades, 1 Blade Ref:- RT-910-91 and
 2 Blades Ref:- RT-910-90

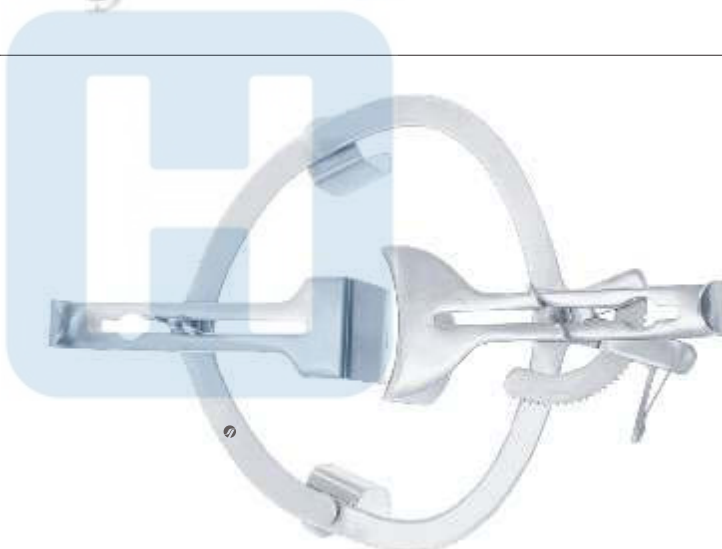

Catalog #	Size
RT-920-00	Standard

O'Sullivan-O'Connor Blade



Catalog #	Size
RT-920-90	80 x 45 mm
RT-920-91	110 x 70 mm

Abdominal Retractors
 Bauchdeckenhalter
 Separadores abdominales
 Ecarteurs abdominaux
 Divaricatori addominali

Kirschner Retractor Complete

With Frame RT-920-30, 3 Blades Ref:- RT-923-50 and
 1 Blade Each of RT-923-80, RT-923-98 and RT-923-99



Catalog #	Size
RT-922-00	Standard

Kirschner Frame Only

Catalog #	Frame Size
RT-922-30	340 x 240 mm



Kirschner Blade

Catalog #	Blade Size
RT-923-40	40 x 55 mm
RT-923-50	50 x 65 mm
RT-923-60	60 x 85 mm
RT-923-78	78 x 65 mm
RT-923-80	80 x 90 mm
RT-923-98	98 x 50 mm
RT-923-99	105 x 35 mm



RT-923-40
 RT-923-50
 RT-923-60
 RT-923-78
 RT-923-80

RT-923-98
 RT-923-99

Abdominal Retractors, Wound Spreaders, self-retaining
 Bauchdeckenhalter, Wundspreizer
 Separadores abdominales, Separadores autoestáticos
 Ecarteurs abdominaux, Ecarteurs autostatiques
 Divaricatori addominali, Divaricatori autostatici

Kirschner Retractor Complete

With Frame RT-924-24, 2 Blades Ref:- RT-923-40
 and 2 Blades Ref:- RT-923-50



Catalog #	Size
RT-924-00	Standard

Kirschner Frame only

Catalog #	Frame Size
RT-924-24	240 x 240 mm



Dennis-Browne Retractor Complete

With Frame RT-930-15 & 2 Blades Each Ref:- RT-930-30
 and RT-930-40



Catalog #	Size
RT-930-00	Standard

Abdominal Retractors, Wound Spreaders, self-retaining
 Bauchdeckenhalter, Wundspreizer
 Separadores abdominales, Separadores autoestáticos
 Ecarteurs abdominaux, Ecarteurs autostatiques
 Divaricatori addominali, Divaricatori autostatici

Dennis-Browne Retractor Frame Only

Catalog #	Frame Size
RT-930-15	175 mm x 150 mm



Dennis-Browne Retractor Blade Only

Catalog #	Blade Size
RT-930-30	40 mm x 30 mm
RT-930-40	40 mm x 40 mm



Cloward Retractor Complete

With 2 Each Lateral Blades Ref:- RT-941-40
 and RT-941-60

Catalog #	Size
RT-940-00	Standard



Cloward Retractor Only

Catalog #	Size
RT-940-01	25 cm (9 3/4")



Wound Spreaders, self-retaining
 Wundspreizer
 Separadores autoestáticos
 Ecarteurs autostatiques
 Divaricatori autostatici

Cloward Lateral Blade
 Toothed

Catalog #	Blade Depth
RT-941-40	40 mm
RT-941-45	45 mm
RT-941-50	50 mm
RT-941-55	55 mm
RT-941-60	60 mm



Cloward Retractor Complete

Complete with 2 Lateral Blades RT-945-40 and RT-945-60

Catalog #	Size
RT-944-00	Standard



Cloward Retractor Frame Only

Catalog #	Size
RT-944-01	15 cm (6")



Cloward Lateral Blade

Catalog #	Blade Depth
RT-945-40	40 mm
RT-945-45	45 mm
RT-945-50	50 mm
RT-945-55	55 mm
RT-945-60	60 mm



Laminectomy Retractors
 Laminektomiesperrer
 Separadores para laminectomia
 Ecarteurs pour laminectomie
 Divaricatori per laminectomia

Scoville Retractor Complete

With Lateral Blades Ref:- RT-953-06 and RT-953-11



Catalog #	Size
RT-950-00	Standard

Scoville Frame Only

Catalog #	Spead
RT-950-01	150 mm

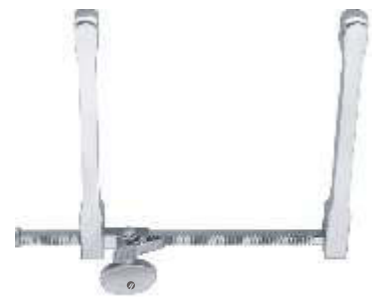

Scoville-Haverfield Retractor Complete

With Lateral Blades Ref:- RT-953-06 and RT-953-11



Catalog #	Size
RT-952-00	Standard

Laminectomy Retractors
 Laminektomiesperrer
 Separadores para laminectomia
 Ecarteurs pour laminectomie
 Divaricatori per laminectomia

Scoville-Haverfield Retractor Frame Only
 Hinged

Catalog #	Spread
RT-952-01	150 mm



Scoville Lateral Blade
 Blunt

Catalog #	Blade Size
RT-953-01	50 mm
RT-953-02	70 mm



Scoville Lateral Blade
 Sharp

Catalog #	Blade Size
RT-953-06	50 mm
RT-953-07	70 mm



Scoville Lateral Blade
 Toothed

Catalog #	Blade Size
RT-953-11	60 x 25 mm
RT-953-12	64 x 50 mm
RT-953-13	88 x 25 mm



Laminectomy Retractors
 Laminektomiesperrer
 Separadores para laminectomía
 Ecarteurs pour laminectomie
 Divaricatori per laminectomia

Taylor Lateral Blade
 Sharp

Catalog #	Blade Size
RT-953-41	48 x 50 mm
RT-953-42	60 x 50 mm
RT-953-43	64 x 64 mm
RT-953-44	80 x 57 mm



Scoville Lateral Blade
 Sharp

Catalog #	Blade Size
RT-953-46	41 x 38 mm
RT-953-47	80 x 57 mm



Scoville-Richter Retractor Complete
 With Lateral Blades Pair Ref:- RT-957-01

Catalog #	Size
RT-956-00	Standard



Scoville-Richter Frame Only

Catalog #	Spead
RT-956-01	155 mm



Laminectomy Retractors
 Laminektomiesperrer
 Separadores para laminectomia
 Ecarteurs pour laminectomie
 Divaricatori per laminectomia

Lateral Blade Pair

Catalog #	Blade Sizes
RT-957-01	62 x 52 mm, 62 x 37 mm



Lateral Blade

Catalog #	Blade Sizes
RT-957-02	47 x 51 mm
RT-957-03	30 x 40 mm
RT-957-04	37 x 62 mm



Caspar Retractor Complete

Catalog #	Size
RT-960-00	Standard



Caspar Retractor Only
 With Key Ref: RT-960-02

Catalog #	Size
RT-960-01	Standard



Laminectomy Retractors
 Laminektomiesperrer
 Separadores para laminectomia
 Ecarteurs pour laminectomie
 Divaricatori per laminectomia

Key for Caspar Retractor



Catalog #	Size
RT-960-02	Standard

Caspar Hook



Catalog #	Depth
RT-961-01	38 mm
RT-961-02	58 mm

Caspar Lateral Blade
 Blade With 2 Prongs



Catalog #	Blade Size
RT-961-03	32 x 22 mm
RT-961-04	37 x 22 mm
RT-961-05	42 x 22 mm
RT-961-06	47 x 22 mm
RT-961-07	52 x 22 mm
RT-961-08	57 x 22 mm
RT-961-09	62 x 22 mm
RT-961-10	67 x 22 mm

Laminectomy Retractors
 Laminektomiesperrer
 Separadores para laminectomia
 Ecarteurs pour laminectomie
 Divaricatori per laminectomia

Caspar Lateral Blade
 Blade With 3 Prongs

Catalog #	Blade Size
RT-961-11	32 x 37 mm
RT-961-12	37 x 37 mm
RT-961-13	42 x 37 mm
RT-961-14	47 x 37 mm
RT-961-15	52 x 37 mm
RT-961-16	57 x 37 mm
RT-961-17	62 x 37 mm
RT-961-18	67 x 37 mm



Caspar Lateral Blade
 Blade With 4 Prongs

Catalog #	Blade Size
RT-961-19	38 x 37 mm
RT-961-20	37 x 37 mm
RT-961-21	42 x 37 mm
RT-961-22	47 x 37 mm
RT-961-23	52 x 37 mm
RT-961-24	57 x 37 mm
RT-961-25	62 x 37 mm
RT-961-26	67 x 37 mm



Cloward Lamina Spreader



Catalog #	Size
RT-973-16	16 cm (6 1/4")

Laminectomy Retractors
 Laminektomiesperrer
 Separadores para laminectomia
 Ecarteurs pour laminectomie
 Divaricatori per laminectomia

Cloward Lamina Spreader



Catalog #	Size
RT-975-13	13.5 cm (5 1/4")

Inge Lamina Spreader



Catalog #	Size
RT-977-17	16 cm (6 1/4")
RT-979-27	25.5 cm (10")

HOSPITA®

ALWAYS THE BEST

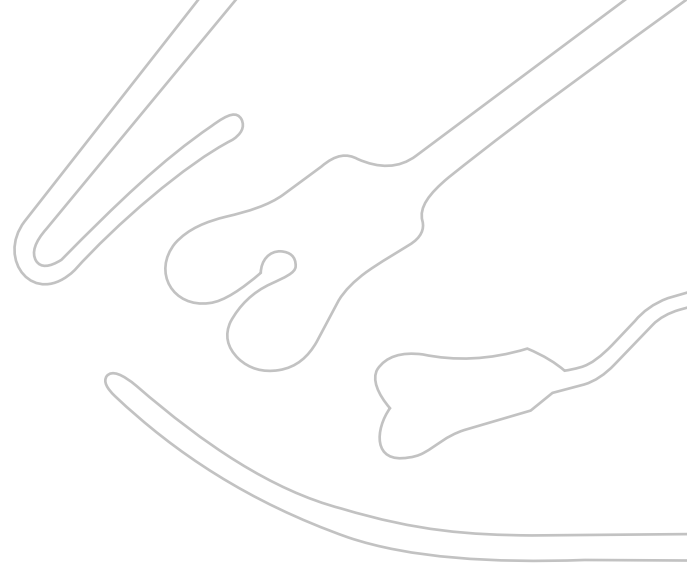

PR



PROBES,
COTTON APPLICATORS,
SPATULAS

Hospita Instrument probes are made to exacting standards and ideal for exploring wounds or body cavities and passages. Our precision-engineered cotton applicators fulfill a variety of applications whether it is to take samples of substances such as tissue from within the body or to apply medication to areas, which have been wounded. cotton applicators always ensure that you have the right tool at hand to meet your objective



Sonden, Watteträger, Spatel

Sondas, Porta-algodones, Espátulas

Sondes, porte-coton, Spatules

Sonde, Portacotoni, spatole

Probes
Knopfsonden
Sondas abotonadas
Sondes boutonées
Sonde a bottone

Probe

Catalog #	Size, Tip Diameter
PR-010-11	11.5 cm (4 1/2"), Ø 1 mm
PR-010-13	13 cm (5"), Ø 1 mm
PR-010-14	14.5 cm (5 3/4"), Ø 1 mm
PR-010-16	16 cm (6 1/4"), Ø 1 mm
PR-010-18	18 cm (7"), Ø 1 mm
PR-010-20	20 cm (8"), Ø 1 mm

Probe

Catalog #	Size
PR-015-11	11.5 cm (4 1/2"), Ø 1.5 mm
PR-015-13	13 cm (5"), Ø 1.5 mm
PR-015-14	14.5 cm (5 3/4"), Ø 1.5 mm
PR-015-16	16 cm (6 1/4"), Ø 1.5 mm
PR-015-18	18 cm (7"), Ø 1.5 mm
PR-015-20	20 cm (8"), Ø 1.5 mm

Probe

Catalog #	Size, Tip Diameter
PR-020-11	11.5 cm (4 1/2"), Ø 2 mm
PR-020-13	13 cm (5"), Ø 2 mm
PR-020-14	14.5 cm (5 3/4"), Ø 2 mm
PR-020-16	16 cm (6 1/4"), Ø 2 mm
PR-020-18	18 cm (7"), Ø 2 mm
PR-020-20	20 cm (8"), Ø 2 mm
PR-020-25	25 cm (9 3/4"), Ø 2 mm
PR-020-30	30 cm (11 3/4"), Ø 2 mm

Probes
Knopfsonden
Sondas abotonadas
Sondes boutonnées
Sonde a bottone

Probe
With Eye



Catalog #	Size, Tip Diameter
PR-030-13	13 cm (5"), Ø 2 mm
PR-030-14	14.5 cm (5 ¾"), Ø 2 mm
PR-030-16	16 cm (6 ¼"), Ø 2 mm

Stacke (Silver) Probe



Catalog #	Size, Tip Diameter
PR-040-10	10 cm (4"), Ø 1 mm

Cawthorne Probe
Flattened End



Catalog #	Size
PR-050-10	14 cm (5 ½")

Myrtle Leaf Probe



Catalog #	Size, Tip Diameter
PR-070-13	13 cm (5"), Ø 2 mm
PR-070-14	14.5 cm (5 ¾"), Ø 2 mm
PR-070-16	16 cm (6 ¼"), Ø 2 mm
PR-070-18	18 cm (7"), Ø 2 mm
PR-070-20	20 cm (8"), Ø 2 mm

Probes, Grooved Directors
 Knopfsonden, Hohlsonden
 Sondas abotonadas, Sondas acanaladas
 Sondes boutonnées, Sondes cannelées
 Sonde a bottone, Sonde cannellate

Killian Probe



Catalog #	Size
PR-081-16	16.5 cm (6 1/2")

Probe



Catalog #	Size
PR-083-16	16 cm (6 1/4")

Ochsner Gall Stone Probe
 Malleable



Catalog #	Size
PR-086-35	35 cm (13 3/4")

Mayo Common Duct Probe
 Malleable



Catalog #	Size, Tip Size
PR-088-05	25.5 cm (10"), 5 mm
PR-088-06	25.5 cm (10"), 6 mm

Seiffert Probe



Catalog #	Size
PR-091-19	19.5 cm (7 3/4")

INCHES
 MILLIMETERS

Probes, Grooved Directors
 Knopfsonden, Hohlsonden
 Sondas abotonadas, Sondas acanaladas
 Sondes boutonnées, Sondes cannelées
 Sonde a bottone, Sonde cannellate

Butterfly Probe / Grooved Director

Catalog #	Size
PR-100-13	13 cm (5")
PR-100-14	14 cm (5 ½")
PR-100-16	16 cm (6 ¼")



Butterfly Probe / Grooved Director With Tip

Catalog #	Size
PR-120-13	13 cm (5")
PR-120-14	14.5 cm (5 ¾")
PR-120-16	16 cm (6 ¼")



Doyen Butterfly Probe / Grooved Director

Catalog #	Size
PR-131-14	14.5 cm (5 ¾")



Nelaton Butterfly Probe / Grooved Director

Catalog #	Size
PR-141-16	16 cm (6 ¼")



Brodie Butterfly Probe / Grooved Director

Catalog #	Size, Tip Diameter
PR-150-20	20 cm (8"), Ø 3.5 mm



Fistula Probes
 Fistelsonden
 Sondas para fistula
 Sondes pour fistule
 Sonde per fistole

Bowman Probes Complete
 Set of 6 Probes

Catalog #	Size
PR-200-00	Standard



Bowman Probes

Catalog #	Size, Profile
PR-202-00	13 cm (5"), Fig. 0000/000
PR-204-00	13 cm (5"), Fig. 00/0
PR-204-12	13 cm (5"), Fig. 1/2
PR-204-34	13 cm (5"), Fig. 3/4
PR-204-56	13 cm (5"), Fig. 5/6
PR-204-78	13 cm (5"), Fig. 7/8



Lockhart-Mummery Fistula Probe
 Fig. 1

Catalog #	Size
PR-250-01	16.5 cm (6 1/2")



Lockhart-Mummery Fistula Probe
 Fig. 2

Catalog #	Size
PR-251-02	16.5 cm (6 1/2")



Lockhart-Mummery Fistula Probe
 Fig. 3

Catalog #	Size
PR-251-03	16.5 cm (6 1/2")



Varix Instruments
 Varizeninstrumente
 Instrumentos para varices
 Instruments pour varices
 Strumenti per varici

Lockhart-Mummery Fistula Probe
 Fig. 4



Catalog #	Size
PR-251-04	16.5 cm (6 1/2")

Pratt Fistula Probe
 Fig. 1



Catalog #	Size, Profile
PR-261-01	21 cm (8 1/4"), Fig. 1
PR-261-02	21 cm (8 1/4"), Fig. 2
PR-261-03	21 cm (8 1/4"), Fig. 3

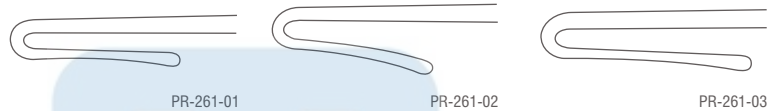

Nabattoff Varicose Vein Probes Complete Set

Catalog #	Size
PR-300-00	Standard



Nabattoff Vein Probe
 Plastic Tip

Catalog #	Size
PR-300-02	Standard



Nabattoff Vein Probe
 Olive Shaped

Catalog #	Tip Diameter
PR-300-03	Ø 3 mm
PR-300-06	Ø 6 mm
PR-300-09	Ø 9 mm
PR-300-12	Ø 12 mm
PR-300-15	Ø 15 mm

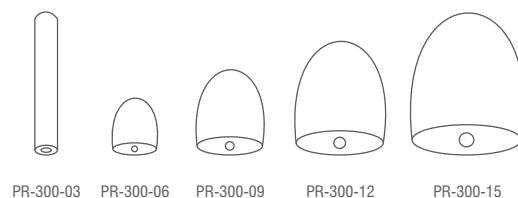

Ring Strippers
 Ringstripper
 Fleboextractores
 Strippers à anneau
 Stripper anello

Nabatoff T Shaped Handle

Catalog #	Size
PR-300-80	Standard

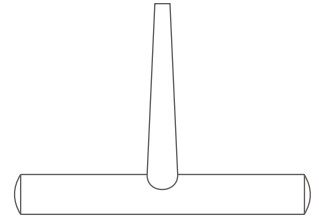

Nabatoff Traction Cable

Catalog #	Size
PR-300-90	Standard

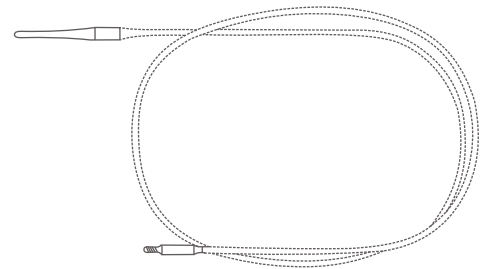

Vollmar Ring Strippers Complete Set

Catalog #	Size
PR-400-00	Standard

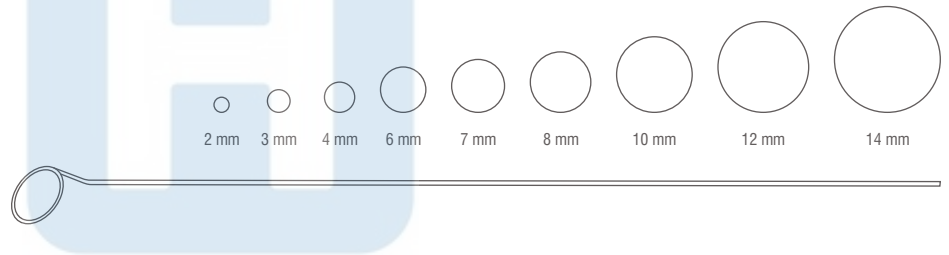

Handle For Vollmar Strippers

Catalog #	Size
PR-400-01	11.5 cm (4 1/2")

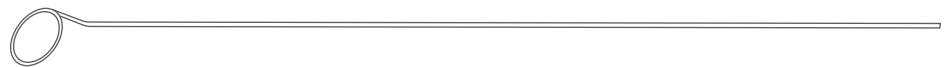

Cotton Applicators, Varix Instruments
 Watteträger, Varizeninstrumente
 Porta algodones, Instrumentos para varices
 Porte-cotons, Instruments pour varices
 Portacottone, Strumenti per varici

Vollmar Ring Stripper

Catalog #	Size, Ring Diameter
PR-401-02	50 cm (19 3/4"), Ø 2 mm
PR-401-03	50 cm (19 3/4"), Ø 3 mm
PR-401-04	50 cm (19 3/4"), Ø 4 mm
PR-401-06	50 cm (19 3/4"), Ø 6 mm
PR-401-07	50 cm (19 3/4"), Ø 7 mm
PR-401-08	50 cm (19 3/4"), Ø 8 mm
PR-401-10	50 cm (19 3/4"), Ø 10 mm
PR-401-12	50 cm (19 3/4"), Ø 12 mm
PR-401-14	50 cm (19 3/4"), Ø 14 mm

2 mm 3 mm 4 mm

6 mm 7 mm 8 mm

10 mm 12 mm 14 mm

Farrell Cotton Applicator Round Spiral End

Catalog #	Size, Working End Diameter
PR-500-12	12 cm (4 3/4"), Ø 0.9 mm
PR-500-14	14 cm (5 1/2"), Ø 0.9 mm
PR-500-16	16 cm (6 1/4"), Ø 1.1 mm
PR-500-18	18 cm (7"), Ø 1.2 mm



Farrell Cotton Applicator Triangular Shaped End

Catalog #	Size, Working End Diameter
PR-520-12	12 cm (4 3/4"), Ø 0.9 mm
PR-520-14	14 cm (5 1/2"), Ø 0.9 mm
PR-520-16	16 cm (6 1/4"), Ø 1.1 mm
PR-520-18	18 cm (7"), Ø 1.2 mm



Varix Instruments
 Varizeninstrumente
 Instrumentos para varices
 Instruments pour varices
 Strumenti per varici

Cotton Application
 Round Spiral End End



Catalog #	Size, Working End Diameter
PR-540-15	18 cm (7"), Ø 1.5 mm
PR-540-18	18 cm (7"), Ø 1.8 mm

Hartmann Cotton Application
 Round Spiral End



Catalog #	Size, Working End Diameter
PR-551-22	22 cm (8 1/2"), Ø 2.3 mm

Jobson-Horne Ear Probe
 Double Ended



Catalog #	Size
PR-561-15	15 cm (6")

Varady Varix Instrument
 Phlebotomizer



Catalog #	Size
PR-600-01	18 cm (7")
PR-600-02	18 cm (7")
PR-600-03	18 cm (7")

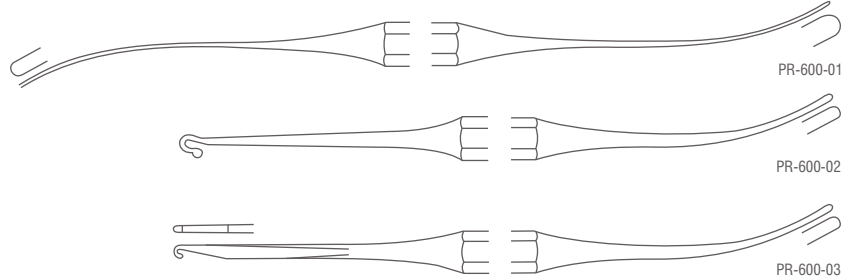

Varady Varix Instrument
 Micro Dissector

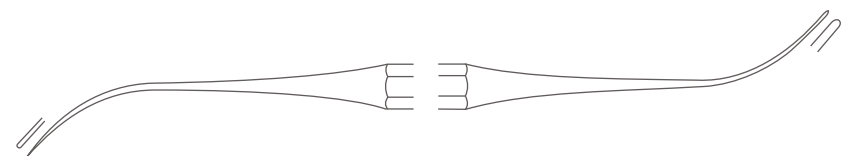

Catalog #	Size
PR-600-04	17.5 cm (7")

Varix Instruments
Varizeninstrumente
Instrumentos para varices
Instruments pour varices
Strumenti per varici

Varady Varix Instrument
Micro Phlebodissector

Catalog #	Size
PR-600-05	18 cm (7")

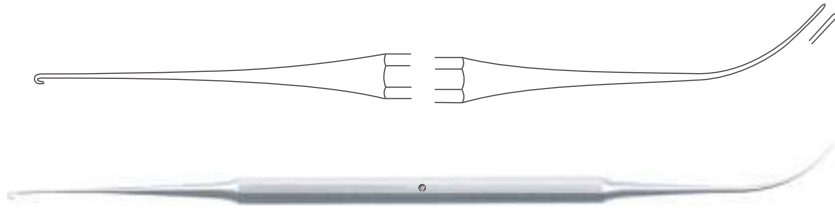

Varady Varix Instrument
Mini Phlebodissector

Catalog #	Size
PR-600-06	18 cm (7")

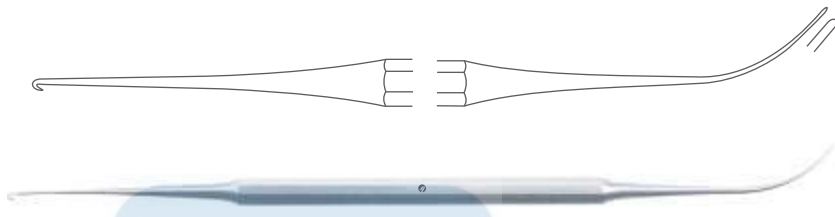

HOSPITA®

ALWAYS THE BEST

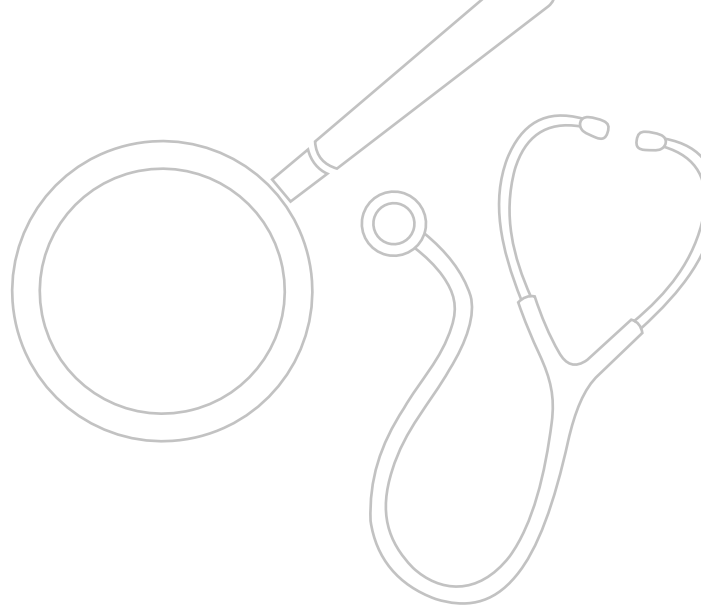

DI



DIAGNOSTIC

State of the art manufacturing techniques, high-grade materials and a constant focus on innovation is the secret behind Surtex Diagnostic product range.

Our Otoscopes guarantee excellent image quality with uniquely bright and reflex-free illumination of the tympanum and auditory canal. Our **Corona** Premium Otoscope features distal fiber optic (F.O.) for bright illumination and maximum vision and are also available in **pollo** Standard featuring direct bulb illumination utilizing Surtex xenon illuminated bulbs.

Ophthalmoscope allows a medical professional to obtain visual access to a portion of the eye known as the fundus. This is the only portion of the eyes in which arteries, veins and nerves can be seen without surgical intervention. At Surtex we realize that a good view of the fundus is vital to assess not only health of the eye but also the overall patient health. Our **Corona** Premium Ophthalmoscope set the industry standard for optical quality and diagnostic accuracy and features distal fiber optic (F.O.) for bright illumination and maximum vision and are also available in **pollo** Standard featuring direct bulb illumination utilizing Surtex xenon illuminated bulbs.

Hospita offers a complete range to cover practically all-surgical requirements, whether an application only needs just a basic ruler or a Jameson caliper, with tolerances so tight as to demand the most accurate and highest resolution

Each product component is designed using the latest CAD techniques to ensure maximum performance and manufactured from materials best suited to the purpose for guaranteed longevity.



Diagnostik

Diagnóstico

Diagnostic

Diagnostica

Percussion Hammers
 Perkussionshämmer
 Martillos para reflejos
 Marteaux-percuteurs
 Martelli percussori

Buck Percussion Hammer
 With Needle and Brush

Catalog #	Size
DI-100-18	18.5 cm (7 1/4")



Dejerine Percussion Hammer

Catalog #	Size
DI-110-20	20 cm (8")



Dejerine Percussion Hammer
 With Needle

Catalog #	Size
DI-112-21	21 cm (8 1/4")

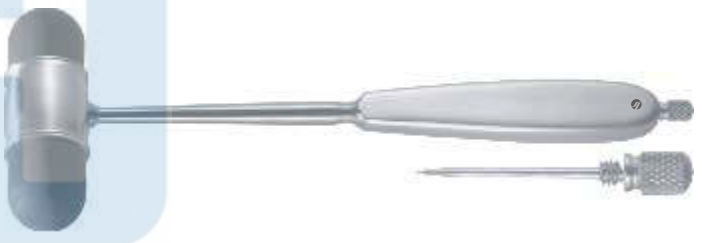

Taylor Mod. USA Percussion Hammer

Catalog #	Size
DI-120-20	20 cm (8")



Babinsky Percussion Hammer
 With Needle

Catalog #	Size
DI-130-22	22 cm (8 3/4")

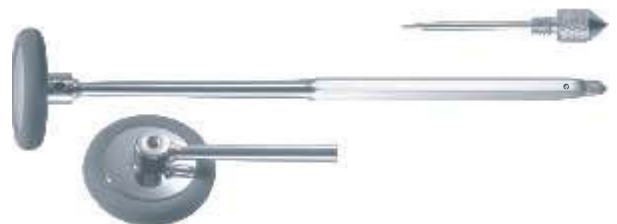

Percussion Hammers, Stethoscopes
 Perkussionshämmer, Stethoskope
 Martillos para reflejos, Estetoscopios
 Marteaux-percuteurs, Stéthoscopes
 Martelli percussori, Stetoscopi

Rabiner Percussion Hammer



Catalog #	Size
DI-132-23	23 cm (9")

Wartenberg Sensibility Instrument



Catalog #	Size
DI-210-19	19 cm (7 1/2")

Pinard Stethoscope Wood



Catalog #	Size
DI-300-18	18 cm (7")

Pinard Stethoscope Aluminium



Catalog #	Size
DI-310-15	15 cm (6")

Duplex-Baby Stethoscope Super Light Weight



Catalog #	Chest Piece Diameter
DI-350-00	Ø 37 mm

Stethoscopes, Blood Pressure Manometers
 Stethoskope, Blutdruckmessgeräte
 Estetoscopios, Manómetros
 Stéthoscopes, Tonomètres
 Stetoscopi, Sfigmomanometri

Duplex Stethoscope
 Super Light Weight

Catalog #	Chest Piece Diameter
DI-380-00	Ø 47 mm



Anaestophon Stethoscope
 Super Light Weight

Catalog #	Chest Piece Diameter
DI-390-00	Ø 47 mm



Diplomat Manometer
 With Velcro Cuff

Catalog #	Size
DI-500-00	Standard



Manometer
 With Velcro Cuff

Catalog #	Size
DI-520-00	Standard



Manometer
 Wall Mounted

Catalog #	Size
DI-550-00	Standard



Head Mirrors, Head Lamps
 Stirnspiegel, Stirnlampen
 Espejos frontales, Lámparas frontales
 Miroirs frontaux, Eclaireurs frontaux
 Specchio frontale, Lampada frontale

Pressofix Tourniquet

Catalog #	Width
DI-585-00	30 mm



Ziegler Head Mirror
 Without Protection Cap

Catalog #	Diameter
DI-600-09	Ø 90 mm



Ziegler Head Mirror
 With Protection Cap

Catalog #	Diameter
DI-601-09	Ø 90 mm



Clar Head Light Complete
 With Transformer

Catalog #	Diameter, Power Source
DI-611-06	Ø 55 mm, 6 Volts



Clar Head Light Complete
 With Transformer

Catalog #	Diameter, Power Source
DI-615-06	Ø 100 mm, 6 Volts



Head Lamps, Magnifying Glass
 Stirnlampen, Stiehlupen
 Lámparas frontales, Lupas
 Eclaireurs frontaux, Loupes
 Lampada frontale, Lenti d`ingrandimento

Head Light
 Xenon Light

Catalog #	Size
DI-651-06	Standard



Magnifying Glass
 Bi-Convex, Metal Handle

Catalog #	Magnification, Glass Diameter
DI-670-50	2.5 x, 50 mm Ø



Magnifying Glass
 Bi-Convex, Plastic Handle

Catalog #	Magnification, Glass Diameter
DI-672-75	2.5 x, 75 mm Ø



Operating Loupe

Catalog #	Magnification, Working Distance
DI-680-00	2.3 x, 340 mm



Operating Loupe

Catalog #	Magnification, Working Distance
DI-690-00	1.8 x, 400 mm



Diagnostic Set
Diagnostikbesteck
Juego para Diagnóstico
Jeu pour diagnostic
Set per diagnostica

DI

DIAGNOSTIC

Corona™ Premium EENT Diagnostic Set

Corona™

Catalog #	Size
DI-730-00	Standard



Corona™ Premium Otoscope

Corona™

Catalog #	Size
DI-732-00	Standard



Corona™ Premium Ophthalmoscope

Corona™

Catalog #	Size
DI-734-00	Standard



Apollo™ Standard Universal EENT Diagnostic Set

pollo™

Catalog #	Size
DI-740-00	Standard



Diagnostic Set, Calipers
 Diagnostikbesteck, Meßzirkel
 Juego para Diagnóstico, Compases
 Jeu pour diagnostic, Compas
 Set per diagnostica, Compassi

Apollo™ Standard Otoscope



Catalog #	Size
DI-742-00	Standard

Apollo™ Standard Ophthalmoscope



Catalog #	Size
DI-744-00	Standard

Apollo™ Standard Dermatoscope



Catalog #	Size
DI-750-00	Standard

Jameson Caliper



Catalog #	Size
DI-801-00	Standard

Carroll Finger Goniometer

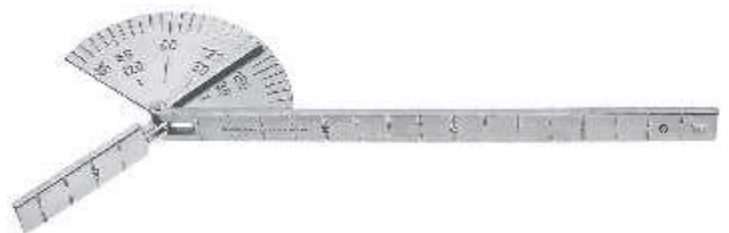

Catalog #	Size
DI-803-14	14.5 cm (5 3/4")

Calipers, Dynamometers, Flexometer
 Schieblehren, Dynamometer, Winkelmesser
 Calibres, Dinamómetros, Goniómetro
 Pieds à coulisse, Dynamomètres, Goniomètres
 Calibro, Dinamometro, Goniometro

Townley Caliper

Graduated in mm and inches



Catalog #	Size
DI-805-11	11.5 cm (4 1/2")

Collin Dynamometer

Graduated in KG, For Adults



Catalog #	Size
DI-810-11	11 cm (4 1/4")

Collin Dynamometer

Graduated in Lbs, For Adults



Catalog #	Size
DI-812-11	11 cm (4 1/4")

Moeltgen Flexometer

For Extremities



Catalog #	Size
DI-820-00	Standard

Vernier Caliper

Graduated in mm and inches



Catalog #	Size, Measuring Range
DI-831-03	23.5 cm (9 1/4"), 150 mm

Calipers
Schieblehren
Calibres
Pieds à coulisse
Calibro

Vernier Caliper

Graduated in mm and inches



Catalog #	Size, Measuring Range
DI-833-22	22.5 cm (8 3/4"), 145 mm

Boley Caliper



Catalog #	Measuring Range
DI-841-00	100 mm

Measuring Caliper



Catalog #	Measuring Range
DI-845-00	100 mm

Castroviejo Caliper

Straight



Catalog #	Size, Measuring Range
DI-850-15	8 cm (3"), 15 mm
DI-850-20	8 cm (3"), 20 mm

Castroviejo-Epker Caliper



Catalog #	Size, Measuring Range
DI-851-20	8 cm (3"), 20 mm

Calipers, Rulers
 Schieblehren, Maßstäbe
 Calibres, Reglas
 Pieds à coulisse, Règles à mesurer
 Calibro, Misuratori

Castroviejo Caliper
 Curved



Catalog #	Size, Measuring Range
DI-852-09	9 cm (3 1/2"), 40 mm
DI-852-18	18 cm (7"), 40 mm

Iwanson Caliper



Catalog #	Size, Measuring Range
DI-860-10	10 cm (4"), 10 mm

Ruler
 Graduated in mm and inches



Catalog #	Size, Measuring Range
DI-880-15	10 cm (4"), 150 mm
DI-880-20	22 cm (8 3/4"), 200 mm
DI-880-30	31.5 cm (12 1/2"), 300 mm
DI-880-50	52.5 cm (20 3/4"), 500 mm

Ruler
 For X-Ray



Catalog #	Size, Measuring Range
DI-884-50	52.5 cm (20 3/4"), 500mm

Measuring Tape
 Graduated in cm and inches



Catalog #	Size
DI-890-15	150 cm (59")

HOSPITA®

ALWAYS THE BEST

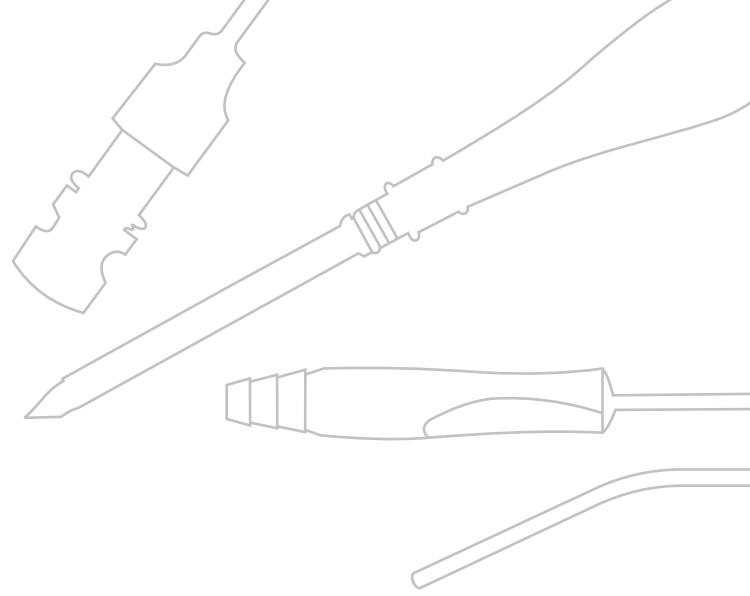

TR



TROCARS, SUCTION
TUBES, CANNULAS

Hospita Trocars, Suction Instruments and Needles feature a lightweight, low profile and ergonomic design that provide hospitals with a cost effective alternative to disposable trocars. Special focus and precision is used on the tips to help placement by clinicians to minimize the risk of trocar injuries during puncturing and effortlessly enable withdrawal of fluid from the body cavity

In this section you will find a comprehensive range including but not limited to suction tubes, hypodermic needles, vessel irrigation cannulas, special needles and guide needles.



Trokare, Saugrohre, Kanülen

Trócares, Tubos de Aspiración, Cánulas

Trocarts, Tubes d'aspiration, Canules

Trequarti, Tubi d'aspirazione, Cannule

Trocars
Trokare
Trócares
Trocart
Trequarti

Universal Trocar

With 4 Trocar Tips Diameter 1.7 mm, 3.0 mm, 4.5 mm and 6.0 mm



Catalog #	Size
TR-010-00	14.5 cm (5 3/4")

Nelson Trocar

22 FG, Fig. 1



Catalog #	Size
TR-020-07	20 cm (8"), Ø 7.5 mm - 22 Charr.
TR-020-09	20 cm (8"), Ø 9.5 mm - 28 Charr.
TR-020-11	20 cm (8"), Ø 11.0 mm - 33 Charr.

Ochsner Trocar

Catalog #	Size, Tip Diameter
TR-030-01	14 cm (5 1/2"), Ø 4 mm
TR-030-02	14 cm (5 1/2"), Ø 4.6 mm
TR-030-03	14 cm (5 1/2"), Ø 5.3 mm
TR-030-04	14 cm (5 1/2"), Ø 6.0 mm
TR-030-05	14 cm (5 1/2"), Ø 6.6 mm
TR-030-06	14 cm (5 1/2"), Ø 7.3 mm
TR-030-07	14 cm (5 1/2"), Ø 8.0 mm
TR-030-08	14 cm (5 1/2"), Ø 8.6 mm



Suction Tube

Catalog #	Size, Tip Diameter
TR-051-14	14 cm (5 1/2"), Ø 1.5 mm
TR-051-18	18 cm (7"), Ø 1.5 mm



Suction Cannulas
Saugrohre
Tubos de aspiración
Tubes d'aspiration
Tubi d'aspirazione

Suction Tube

Catalog #	Size, Tip Diameter
TR-053-14	14 cm (5 1/2"), Ø 2.5 mm
TR-053-18	18 cm (7"), Ø 2.5 mm



Suction Tube

Catalog #	Size, Tip Diameter
TR-055-14	14 cm (5 1/2"), Ø 3.0 mm
TR-055-18	18 cm (7"), Ø 3.0 mm



Suction Tube

Catalog #	Size, Tip Diameter
TR-057-14	14 cm (5 1/2"), Ø 4.0 mm
TR-057-18	18 cm (7"), Ø 4.0 mm



Suction Tube

Catalog #	Size, Tip Diameter
TR-059-14	14 cm (5 1/2"), Ø 6.0 mm
TR-059-18	18 cm (7"), Ø 6.0 mm



Suction Cannulas
Saugrohre
Tubos de aspiración
Tubes d'aspiration
Tubi d'aspirazione

Adson Suction Tube

12 Charr.



Catalog #	Size, Diameter
TR-091-20	20 cm (8"), Ø 4.0 mm

Frazier Suction Tube



Catalog #	Size, Diameter
TR-094-24	24 cm (9 1/2"), Ø 3.3 mm - 10 Charr.

Frazier Suction Tube



Catalog #	Size, Diameter
TR-101-06	19.5 cm (7 3/4"), Ø 2.0 mm - 6 Charr.
TR-101-07	19.5 cm (7 3/4"), Ø 2.3 mm - 7 Charr.
TR-101-08	19.5 cm (7 3/4"), Ø 2.7 mm - 8 Charr.
TR-101-09	19.5 cm (7 3/4"), Ø 3.0 mm - 9 Charr.
TR-101-10	19.5 cm (7 3/4"), Ø 3.3 mm - 10 Charr.
TR-101-11	19.5 cm (7 3/4"), Ø 3.6 mm - 11 Charr.
TR-101-12	19.5 cm (7 3/4"), Ø 4.0 mm - 12 Charr.
TR-101-13	19.5 cm (7 3/4"), Ø 5.0 mm - 15 Charr.

Fergusson Suction Tube



Catalog #	Size, Diameter
TR-111-05	18 cm (7"), Ø 1.7 mm - 5 Charr.
TR-111-06	18 cm (7"), Ø 2.0 mm - 6 Charr.
TR-111-08	18 cm (7"), Ø 2.5 mm - 8 Charr.
TR-111-09	18 cm (7"), Ø 3.0 mm - 9 Charr.
TR-111-12	18 cm (7"), Ø 4.0 mm - 12 Charr.
TR-111-13	18 cm (7"), Ø 5.0 mm - 15 Charr.

Suction Cannulas
Saugrohre
Tubos de aspiración
Tubes d'aspiration
Tubi d'aspirazione

Zoellner Suction Tube Complete

Catalog #	Size
TR-131-00	N/A



Zoellner Suction Handle Only

Catalog #	Size
TR-131-01	N/A

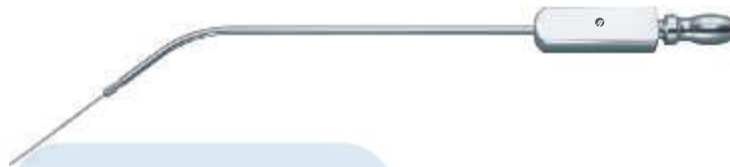

Zoellner Suction Tip Only

Catalog #	Diameter
TR-132-05	Ø 0.5 mm
TR-132-07	Ø 0.7 mm
TR-132-09	Ø 0.9 mm
TR-132-12	Ø 1.2 mm

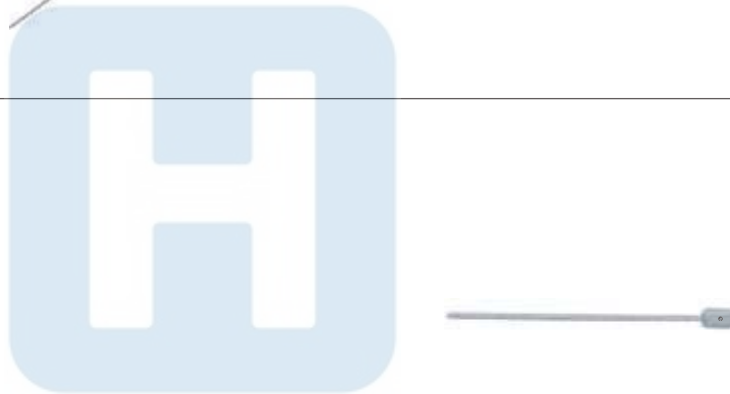

Wullstein Suction Tube Complete

With Suction Handle and Micro Suction Tube Ref: TR-142-04, TR-142-06, TR-142-08

Catalog #	Size
TR-141-00	14 cm (5 ½")



Wullstein Suction Handle Only

Catalog #	Size
TR-141-01	14 cm (5 ½")



Suction Cannulas
 Saugrohre
 Tubos de aspiración
 Tubes d'aspiration
 Tubi d'aspirazione

Wullstein Micro Suction Handle

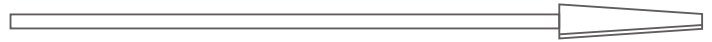

Catalog #	Size, Diameter
TR-142-04	4.5 cm (1 3/4"), Ø 0.4 mm
TR-142-06	4.5 cm (1 3/4"), Ø 0.6 mm
TR-142-08	4.5 cm (1 3/4"), Ø 0.8 mm

Baron-Schuknecht Suction Handle
 With Finger Cut Off

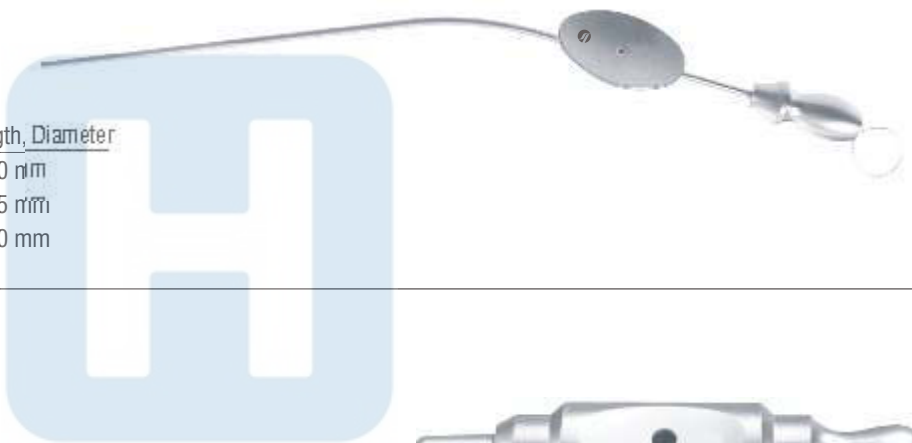

Catalog #	Working Length, Diameter
TR-151-10	Ø 75 mm, 1.0 mm
TR-151-15	Ø 75 mm, 1.5 mm
TR-151-20	Ø 75 mm, 2.0 mm

House Suction Adapter
 With Finger Cut Off



Catalog #	Size
TR-180-00	N/A

Verhoeven Suction Cannula
 With Luer Cone



Catalog #	Diameter
TR-185-05	Ø 0.5 mm
TR-185-07	Ø 0.7 mm
TR-185-10	Ø 1.0 mm
TR-185-12	Ø 1.2 mm
TR-185-15	Ø 1.5 mm

Suction Cannulas
Saugrohre
Tubos de aspiración
Tubes d'aspiration
Tubi d'aspirazione

House Suction Tube
With Finger Cutt Off



Catalog #	Suction Diameter, Irrigation Diameter
TR-191-09	Ø 0.9 mm, 0.7 mm
TR-191-12	Ø 1.2 mm, 0.9 mm
TR-191-15	Ø 1.5 mm, 1.2 mm

Luer Suction Tube



Catalog #	Working Length, Diameter
TR-201-30	Ø 110 mm, 3.0 mm
TR-201-35	Ø 110 mm, 3.5 mm
TR-201-45	Ø 110 mm, 4.5 mm

Yasargil Suction Tube
With Luer Hub

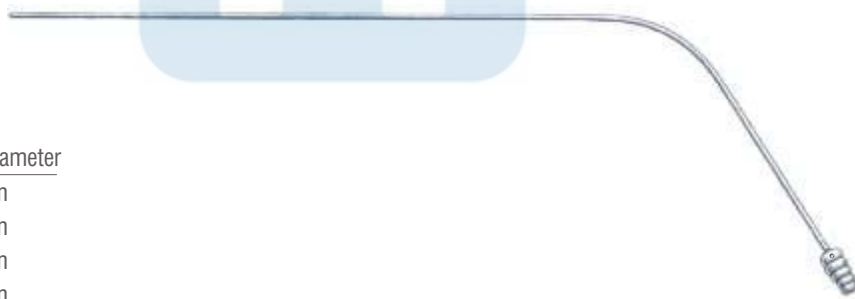

Catalog #	Working Length, Diameter
TR-221-15	Ø 130 mm, 1.5 mm
TR-221-20	Ø 130 mm, 2.0 mm
TR-221-25	Ø 130 mm, 2.5 mm
TR-221-35	Ø 130 mm, 3.5 mm

Yasargil Suction Tube
With Luer Hub

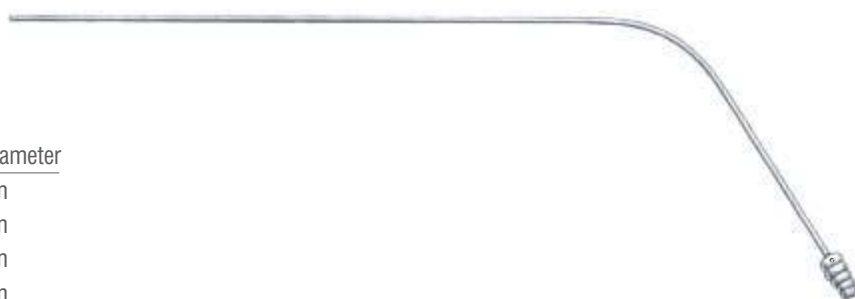

Catalog #	Working Length, Diameter
TR-223-15	Ø 150 mm, 1.5 mm
TR-223-20	Ø 150 mm, 2.0 mm
TR-223-25	Ø 150 mm, 2.5 mm
TR-223-35	Ø 150 mm, 3.5 mm

Suction Tubes
 Sauger
 Tubos de aspiración
 Tubes d'aspiration
 Tubi d'aspirazione

Yasargil Suction Tube
 With Luer Hub

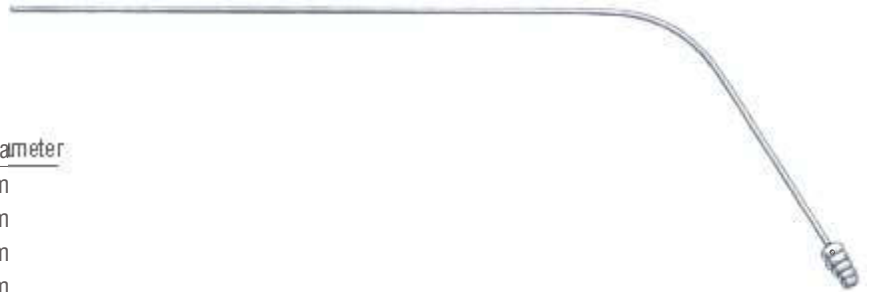

Catalog #	Working Length, Diameter
TR-225-15	Ø 180 mm, 1.5 mm
TR-225-20	Ø 180 mm, 2.0 mm
TR-225-25	Ø 180 mm, 2.5 mm
TR-225-35	Ø 180 mm, 3.5 mm

Yasargil Suction Tube
 With Luer Hub

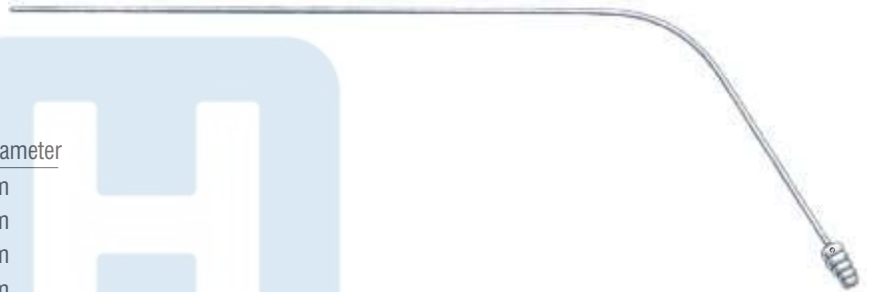

Catalog #	Working Length, Diameter
TR-227-15	Ø 220 mm, 1.5 mm
TR-227-20	Ø 220 mm, 2.0 mm
TR-227-25	Ø 220 mm, 2.5 mm
TR-227-35	Ø 220 mm, 3.5 mm

Suction Raspatory
 Sharp, Bayonet Shaped



Catalog #	Size, Width
TR-241-04	20 cm (8"), 4.0 mm
TR-241-05	20 cm (8"), 5.0 mm

Landolt Dissecting Suction Tube
 Sharp



Catalog #	Size, Width
TR-243-32	20 cm (8"), 3.2 mm

Suction Tubes
Sauger
Tubos de aspiración
Tubes d'aspiration
Tubi d'aspirazione

Yankauer Suction Tube Complete

Catalog #	Size
TR-251-27	31 cm (21 1/4")



Yankauer Suction Tube Complete (Detachable) With Handle, 4 Tube, Suction Tip and Tube Connector

Catalog #	Size
TR-255-00	31 cm (21 1/4")



Yankauer Suction Handle Only

Catalog #	Size
TR-255-01	15 cm (6")

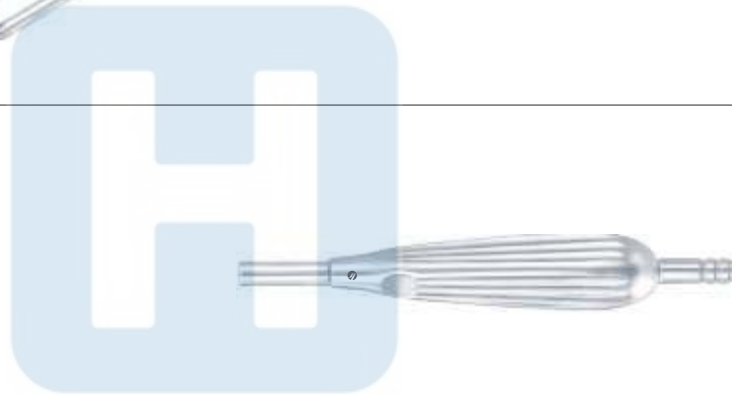

Yankauer Suction Connector Only Oval Shaped

Catalog #	Size
TR-255-02	2.5 cm (1")



Yankauer Suction Tube Only

Catalog #	Size, Profile
TR-255-10	10 cm (4"), Fig. 0
TR-255-11	10 cm (4"), Fig. 1
TR-255-12	10 cm (4"), Fig. 2
TR-255-13	10 cm (4"), Fig. 3



Suction Tubes
 Sauger
 Tubos de aspiración
 Tubes d'aspiration
 Tubi d'aspirazione

Yankauer Suction Tip



Catalog #	Size
TR-255-15	N/A

Poole Suction Tube



Catalog #	Size, Diameter
TR-270-22	22 cm (8 3/4"), Ø 10.0 mm

Poole Suction Tube



Catalog #	Size, Diameter
TR-271-22	22.5 cm (8 3/4"), Ø 8.0 mm

Poole-Baby Suction Tube



Catalog #	Size, Diameter
TR-273-20	22 cm (8"), Ø 5.5 mm

Coolley Suction Tube



Catalog #	Size, Diameter
TR-281-35	36 cm (8 1/4"), Ø 8.0 mm

Suction Tubes
 Sauger
 Tubos de aspiración
 Tubes d'aspiration
 Tubi d'aspirazione

Cooley Suction Tube
 With Perforated Screw Tip



Catalog #	Size, Diameter
TR-283-31	31 cm (12 1/4"), Ø 10.0 mm

Cooley Suction Tube
 With Perforated Screw Tip



Catalog #	Size, Diameter
TR-285-30	31 cm (12 1/4"), Ø 7.0 mm

Cooley Suction Tube
 With Perforated Screw Tip



Catalog #	Size, Diameter
TR-287-33	36 cm (12 1/4"), Ø 8.0 mm

DeBakey Suction Tube



Catalog #	Size, Diameter
TR-291-27	27.5 cm (10 3/4"), Ø 9.0 mm

Finsterer Suction Tube



Catalog #	Size, Diameter
TR-301-32	32 cm (12 3/4"), Ø 15.0 mm

Suction Tubes
 Sauger
 Tubos de aspiración
 Tubes d'aspiration
 Tubi d'aspirazione

Nuboer Suction Tube
 Round Opening



Catalog #	Size, Diameter
TR-311-21	21 cm (8 1/4"), Ø 6.0 mm

Nuboer Suction Tube
 Oval Opening



Catalog #	Size, Diameter
TR-313-21	21 cm (8 1/4"), Ø 6.0 mm

Coupland Suction Tube Complete
 With Suction Tips Ref: TR-323-05 to TR-323-08



Catalog #	Size
TR-321-00	N/A

Coupland Suction Handle
 With Tube Connector



Catalog #	Size
TR-322-24	17 cm (6 3/4")

Coupland Suction Tip
 Laterally Perforated



Catalog #	Size, Diameter
TR-323-05	9 cm (3 1/2"), Ø 1.5 mm
TR-323-06	9 cm (3 1/2"), Ø 2.0 mm
TR-323-07	9 cm (3 1/2"), Ø 2.5 mm
TR-323-08	9 cm (3 1/2"), Ø 3.5 mm

Suction Tubes, Hypodermic Needles
 Sauger, Injektionskanülen
 Tubos de aspiración, Agujas hipodérmicas
 Tubes d'aspiration, Aiguilles hypodermiques
 Tubi d'aspirazione, Cannule per iniezione

Byrd Suction Tube



Catalog #	Size, Diameter
TR-341-30	21.5 cm (8 1/2"), Ø 3.0 mm
TR-341-38	21.5 cm (8 1/2"), Ø 2.5 mm
TR-341-43	21.5 cm (8 1/2"), Ø 3.5 mm

Cogswell Suction Tube

With Finger Cutt Off



Catalog #	Size, Diameter
TR-345-23	24.5 cm (9 3/4"), Ø 2.0 mm

Hypodermic Needle

Set of 7 Ref: TR-602-01 Up to TR-602-20



Catalog #	Size, Diameter
TR-400-00	24.5 cm (9 3/4"), Ø 2.0 mm

Hypodermic Needle

Catalog #	Needle Size, Profile
TR-400-01	0.85 x 40 mm, Fig. 1
TR-400-02	0.80 x 35 mm, Fig. 2
TR-400-12	0.70 x 32 mm, Fig. 12
TR-400-14	0.65 x 30 mm, Fig. 14
TR-400-16	0.60 x 25 mm, Fig. 16
TR-400-18	0.50 x 23 mm, Fig. 18
TR-400-20	0.45 x 18 mm, Fig. 20



Special Needles
Spezialkanülen
Agujas especiales
Aiguilles spéciales
Aghi speciali

Pudendus Anaesthesia Needle
Complete With Cannula



Catalog #	Size, Cannula Size
TR-410-00	18 cm (7"), Ø 1.0 x 185 mm

Vein Cannula
Button End, With Tube Connector



Catalog #	Cannula Size
TR-420-12	Ø 1.2 x 80 mm
TR-420-15	Ø 1.5 x 80 mm

Quinke Lumbar Puncture Needle
18 G, 19 G, 22 G, With Luer Lock Connection

Catalog #	Needle Size
TR-450-10	Ø 1.2 x 76 mm
TR-450-12	Ø 1.2 x 89 mm
TR-450-14	Ø 1.0 x 76 mm
TR-450-16	Ø 1.0 x 89 mm
TR-450-18	Ø 0.7 x 76 mm
TR-450-19	Ø 0.7 x 50 mm
TR-450-20	Ø 0.7 x 89 mm



Tuohy Lumbar Puncture Needle
18 G, 17 G, 16 G, With Luer Lock Connection, Special Tip

Catalog #	Needle Size
TR-460-12	Ø 1.2 x 76 mm
TR-460-14	Ø 1.4 x 76 mm
TR-460-16	Ø 1.4 x 35 mm



Special Needles
Spezialkanülen
Agujas especiales
Aiguilles spéciales
Aghi speciali

Menghini Liver Puncture Needle
Blind Lever Puncture, With Stopping Needle

Catalog #	Needle Size
TR-470-10	Ø 1.0 x 35 mm
TR-470-15	Ø 1.0 x 70 mm
TR-470-20	Ø 1.2 x 70 mm
TR-470-25	Ø 1.2 x 100 mm
TR-470-30	Ø 1.4 x 70 mm
TR-470-35	Ø 1.4 x 100 mm
TR-470-40	Ø 1.6 x 70 mm
TR-470-50	Ø 1.8 x 100 mm



Menghini Liver Puncture Needle
For Controlled Blind Lever Puncture

Catalog #	Needle Size
TR-472-14	Ø 1.4 x 168 mm
TR-472-18	Ø 1.8 x 168 mm

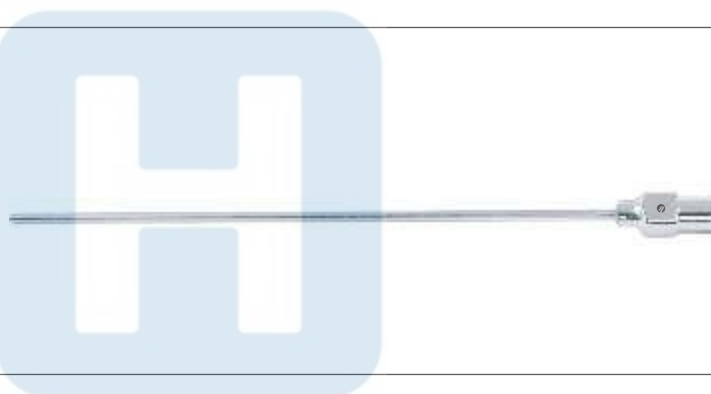

Lichtwitz Antrum Puncture Needle

Catalog #	Needle Size
TR-480-15	Ø 1.5 x 90 mm
TR-480-18	Ø 1.8 x 90 mm
TR-480-20	Ø 2.0 x 90 mm



Tonsil Needle
Tapered Tip, With Luer Lock Connection

Catalog #	Needle Diameter
TR-490-10	Ø 0.65 mm



Special Needles, Vessel Irrigation Cannulas
 Spezialkanülen, Gefäß-Spülkanülen
 Aguja especiales, Cánulas para irrigación vascular
 Aiguilles spéciales, Canules pour irrigation vasculaire
 Aghi speciali, Cannule per irrigazione vascolare

Tonsil Needle
 Tapered Tip, With Luer Lock Connection



Catalog #	Needle Diameter
TR-491-15	Ø 0.65 mm

Tonsil Needle
 Tapered Tip, With Luer Lock Connection



Catalog #	Needle Diameter
TR-493-20	Ø 0.65 mm

Verres Insufflation Cannula
 With Luer Lock Connection



Catalog #	Size, Cannula Size
TR-500-20	N/A, Ø 2.0 x 100 mm

Verres Insufflation Cannula
 With Luer Lock Connection



Catalog #	Size, Cannula Size
TR-502-20	N/A, Ø 2.0 x 120 mm

Vollmar Vessel Irrigation Cannula
 With Luer Lock Connection



Catalog #	Size, Diameter
TR-520-15	6 cm (2 1/4"), Ø 1.5 mm
TR-520-20	6 cm (2 1/4"), Ø 2.0 mm
TR-520-25	6 cm (2 1/4"), Ø 2.5 mm
TR-520-30	6 cm (2 1/4"), Ø 3.0 mm
TR-520-40	6 cm (2 1/4"), Ø 4.0 mm

Vessel Irrigation Cannulas, Hypodermic Syringes
 Gefäß-Spülkanülen, Spritzen
 Cánulas para irrigación vascular, Jeringas
 Canules pour irrigation vasculaire, Seringues
 Cannule per irrigazione vascolare, Siringhe

Schmid Vessel Irrigation Cannula
 Malleable, With Luer Lock Connection



Catalog #	Size, Diameter
TR-530-03	15 cm (6"), Ø 3.0 mm
TR-530-04	15 cm (6"), Ø 4.0 mm
TR-530-05	15 cm (6"), Ø 5.0 mm
TR-530-06	15 cm (6"), Ø 6.0 mm

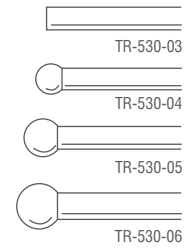

Mock Heparin Flushing Needle
 Button End With Luer Lock Connection



Catalog #	Size, Tip Size
TR-550-06	6.5 (2 1/2"), Ø 2.9 x 0.8 mm

3 Ring Hypodermic Syringe
 Glass Barrel, With Luer Lock Connection, Moveable Rings



Catalog #	Capacity
TR-600-02	2 ml
TR-600-05	5 ml
TR-600-10	10 ml

Janet Wound and Bladder Syringe
 Glass Barrel, With 2 Exchangeable Tips



Catalog #	Capacity
TR-610-05	50 ml
TR-610-10	100 ml
TR-610-15	150 ml
TR-610-20	200 ml

Guide Needles
Führungsnadeln
Agujas de guía
Aiguilles d'introduction
Aghi conduttori

Redon Guide Needle Knife Tip



Catalog #	Size, Tip Size
TR-701-08	19.5 cm (7 3/4"), 2.7 mm - 8 Charr.
TR-701-10	19.5 cm (7 3/4"), 3.3 mm - 10 Charr.
TR-701-12	19.5 cm (7 3/4"), 4.0 mm - 12 Charr.
TR-701-14	19.5 cm (7 3/4"), 4.7 mm - 14 Charr.
TR-701-16	19.5 cm (7 3/4"), 5.3 mm - 16 Charr.
TR-701-18	19.5 cm (7 3/4"), 6 mm - 18 Charr.

Redon Guide Needle Knife Tip

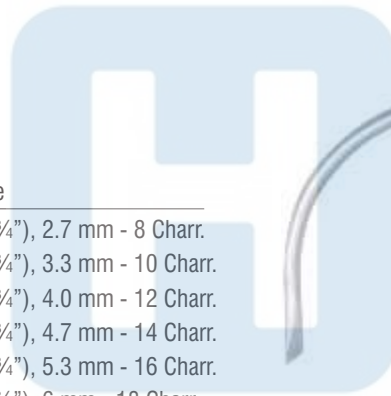

Catalog #	Size, Tip Size
TR-703-08	19.5 cm (7 3/4"), 2.7 mm - 8 Charr.
TR-703-10	19.5 cm (7 3/4"), 3.3 mm - 10 Charr.
TR-703-12	19.5 cm (7 3/4"), 4.0 mm - 12 Charr.
TR-703-14	19.5 cm (7 3/4"), 4.7 mm - 14 Charr.
TR-703-16	19.5 cm (7 3/4"), 5.3 mm - 16 Charr.
TR-703-18	19.5 cm (7 3/4"), 6 mm - 18 Charr.

Redon Guide Needle Lancet Tip



Catalog #	Size, Tip Size
TR-705-08	19.5 cm (7 3/4"), 2.7 mm - 8 Charr.
TR-705-10	19.5 cm (7 3/4"), 3.3 mm - 10 Charr.
TR-705-12	19.5 cm (7 3/4"), 4.0 mm - 12 Charr.
TR-705-14	19.5 cm (7 3/4"), 4.7 mm - 14 Charr.
TR-705-16	19.5 cm (7 3/4"), 5.3 mm - 16 Charr.
TR-705-18	19.5 cm (7 3/4"), 6 mm - 18 Charr.

Guide Needles
Führungsnadeln
Agujas de guía
Aiguilles d'introduction
Aghi conduttori

Redon Guide Needle
Lancet Tip



Catalog #	Size, Tip Size
TR-707-08	19.5 cm (7 ¾"), 2.7 mm - 8 Charr.
TR-707-10	19.5 cm (7 ¾"), 3.3 mm - 10 Charr.
TR-707-12	19.5 cm (7 ¾"), 4.0 mm - 12 Charr.
TR-707-14	19.5 cm (7 ¾"), 4.7 mm - 14 Charr.
TR-707-16	19.5 cm (7 ¾"), 5.3 mm - 16 Charr.
TR-707-18	19.5 cm (7 ¾"), 6 mm - 18 Charr.



HOSPITA®

ALWAYS THE BEST

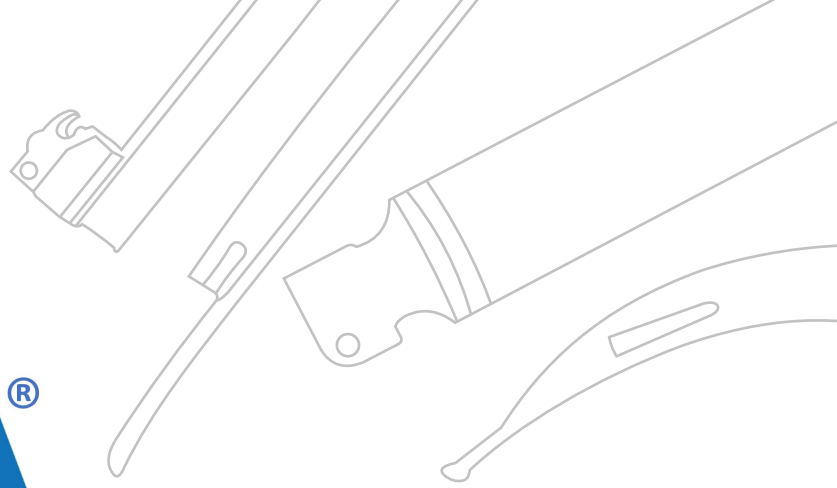

AN

ANESTHESIA

Hospita Laryngoscopes are designed and manufactured to make intubation simple, convenient and as safe as possible. The outcome is a broad product range featuring innovative design, performance, quality and overall value

Our range features all popular Macintosh & Miller patterns. Our **Corona™** premium laryngoscopes and **MAXBright™** LED sets the industry standard for effortless atraumatic intubation and features distal fibre optic (F.O) for bright illumination and maximum vision of the epiglottis and vocal cords. Our **pollo™** standard features direct bulb illumination utilizing Surtex xenon illuminated bulbs.



Narkose

Anestesia

Anesthésie

Anestesia

Catheter Introducing Forceps, Laryngoscopes and Accessories
 Kathetereinführzangen, Laryngoskope und Zubehör
 Pinzas para catéteres, Laringoscopios y accesorios
 Pinces pour introduire les sondes, Laryngoscopes et accessoires
 Pinze per introdurre le sonde, Laringoscopi ed accessori

Magill Catheter Introducing Forcep
 For Babies



Catalog #	Size
AN-010-15	14.5 cm (5 ¾"), For Babies
AN-010-20	20 cm (8"), For Children
AN-010-25	25 cm (9 ¾"), For Adults

Apollo™ Standard Miller-Baby Laryngoscope Set
 With Battery Handle Ref: AN-290-01 and 2 Blades Ref: AN-110-00 to AN-110-01



Catalog #	Size
AN-100-00	Standard



Apollo™ Standard Miller Laryngoscope Set
 With Battery Handle Ref: AN-290-01 and 3 Blades Ref: AN-110-01 to AN-110-03



Catalog #	Size
AN-101-00	Standard



Apollo™ Standard Miller Laryngoscope Set
 With Battery Handle Ref: AN-290-01 and 4 Blades Ref: AN-110-01 to AN-110-04



Catalog #	Size
AN-102-00	Standard



Apollo™ Standard Miller Laryngoscope Set
 With Battery Handle Ref: AN-290-01 and 5 Blades Ref: AN-110-00 to AN-110-04



Catalog #	Size
AN-103-00	Standard



Laryngoscopes and Accessories
 Laryngoskope und Zubehör
 Laringoscopios y accesorios
 Laryngoscopes et accessoires
 Laringoscopi ed accessori

Apollo™ Standard Miller Laryngoscope Blade



Catalog #	Blade Length, Fig, Usage
AN-110-00	55 mm, Fig. 0, For Babies
AN-110-01	80 mm, Fig. 1, For Children
AN-110-02	130 mm, Fig. 2, Adolescents
AN-110-03	170 mm, Fig. 3, Women
AN-110-04	180 mm, Fig. 4, Men



Apollo™ Standard McIntosh-Baby Laryngoscope Set

With Battery Handle Ref: AN-290-01 and 2 Blades Ref: AN-210-00 to AN-210-01



Catalog #	Size
AN-200-00	Standard



Apollo™ Standard McIntosh Laryngoscope Set

With Battery Handle Ref:- AN-290-01 and 3 Blades Ref:- AN-210-01 to AN-210-03



Catalog #	Size
AN-201-00	Standard



Apollo™ Standard McIntosh Laryngoscope Set

With Battery Handle Ref:- AN-290-01 and 4 Blades Ref:- AN-210-01 to AN-210-04



Catalog #	Size
AN-202-00	Standard



Apollo™ Standard McIntosh Laryngoscope Set

With Battery Handle Ref:- AN-290-01 and 5 Blades Ref:- AN-210-00 to AN-210-04



Catalog #	Size
AN-203-00	Standard



Laryngoscopes and Accessories
 Laryngoskope und Zubehör
 Laringoscopios y accesorios
 Laryngoscopes et accessoires
 Laringoscopi ed accessori

Apollo™ Standard McIntosh Laryngoscope Blade
 Fig. 0, For Babies



Catalog #	Blade Length, Fig, Usage
AN-210-00	55 mm, Fig. 0, For Babies
AN-210-01	75 mm, Fig. 1, For Children
AN-210-02	90 mm, Fig. 2, For Adolescents
AN-210-03	110 mm, Fig. 3, For Women
AN-210-04	135 mm, Fig. 4, For Men



Apollo™ Standard Battery Handle
 Chrome Plated



Catalog #	Size
AN-290-01	Standard

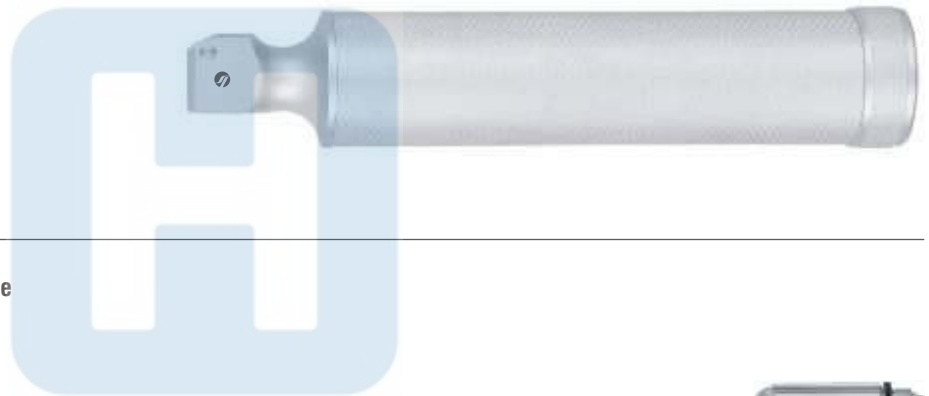

Apollo™ Standard Spare Bulb Large
 For Blades Fig. 2 to 4



Catalog #	Size
AN-294-01	Standard



Apollo™ Standard Spare Bulb Small
 For Blades Fig. 0 to 1



Catalog #	Size
AN-294-02	Standard



Laryngoscopes and Accessories
 Laryngoskope und Zubehör
 Laringoscopios y accesorios
 Laryngoscopes et accessoires
 Laringoscopi ed accessori

Corona™ Premium Fibre Optic McIntosh-Baby Laryngoscope Set
 With Battery Handle Ref:- AN-590-01 and 2 Blades Ref:- AN-410-00 to AN-410-01



Catalog #	Size
AN-400-00	Standard



Corona™ Premium Fibre Optic McIntosh Laryngoscope Set
 With Battery Handle Ref:- AN-590-01 and 3 Blades Ref:- AN-410-01 to AN-410-03



Catalog #	Size
AN-401-00	Standard



Corona™ Premium Fibre Optic McIntosh Laryngoscope Set
 With Battery Handle Ref:- AN-590-01 and 4 Blades Ref:- AN-410-01 to AN-410-04



Catalog #	Size
AN-402-00	Standard



Corona™ Premium Fibre Optic McIntosh Laryngoscope Set
 With Battery Handle Ref:- AN-590-01 and 5 Blades Ref:- AN-410-00 to AN-410-04



Catalog #	Size
AN-403-00	Standard



Corona™ Premium Fibre Optic McIntosh Laryngoscope Blade



Catalog #	Blade Length, Fig, Usage
AN-410-00	55 mm, Fig. 0, For Babies
AN-410-01	70 mm, Fig. 1, For Children
AN-410-02	80 mm, Fig. 2, For Adolescents
AN-410-03	105 mm, Fig. 3, For Women
AN-410-04	130 mm, Fig. 4, For Men



Laryngoscopes and Accessories
 Laryngoskope und Zubehör
 Laringoscopios y accesorios
 Laryngoscopes et accessoires
 Laringoscopi ed accessori

Corona™ Premium Fibre Optic Miller-Baby Laryngoscope Set

With Battery Handle Ref:- AN-590-01 and 2 Blades Ref:- AN-510-00 to AN-510-01



Catalog #	Size
AN-500-00	Standard



Corona™ Premium Fibre Optic Miller Laryngoscope Set

With Battery Handle Ref:- AN-590-01 and 3 Blades Ref:- AN-510-01 to AN-510-03



Catalog #	Size
AN-501-00	Standard



Corona™ Premium Fibre Optic Miller Laryngoscope Set

With Battery Handle Ref:- AN-590-01 and 4 Blades Ref:- AN-510-01 to AN-510-04



Catalog #	Size
AN-502-00	Standard



Corona™ Premium Fibre Optic Miller Laryngoscope Set

With Battery Handle Ref:- AN-590-01 and 5 Blades Ref:- AN-510-00 to AN-510-04



Catalog #	Size
AN-503-00	Standard



Corona™ Premium Fibre Optic Miller Laryngoscope Blade

Fig. 0, For Babies



Catalog #	Blade Length, Fig, Usage
AN-510-00	55 mm, Fig. 0, For Babies
AN-510-01	80 mm, Fig. 1, For Children
AN-510-02	130 mm, Fig. 2, For Adolescents
AN-510-03	170 mm, Fig. 3, For Women
AN-510-04	180 mm, Fig. 4, For Men



Laryngoscopes and Accessories
Laryngoskope und Zubehör
Laringoscopios y accesorios
Laryngoscopes et accessoires
Laringoscopi ed accessori

Corona™ Premium Fibre Optic Battery Handle
With 2.5 Volts Xenon Bulb



Catalog #	Size
AN-590-01	Standard



Corona™ Premium Fibre Optic Battery Handle
Slim Profile, With 2.5 Volts Xenon Bulb



Catalog #	Size
AN-592-02	Standard



Corona™ Premium Fibre Optic Spare Bulb
Xenon



Catalog #	Power Rating
AN-594-01	2.5 V



Laryngoscopes and Accessories
 Laryngoskope und Zubehör
 Laringoscopios y accesorios
 Laryngoscopes et accessoires
 Laringoscopi ed accessori

MaxBright™ LED Fibre Optic McIntosh-Baby Laryngoscope Set

With Battery Handle Ref:- AN-890-01 and 2 Blades Ref:- AN-710-00 to AN-710-01



Catalog #	Size
AN-700-00	Standard



MaxBright™ LED Fibre Optic McIntosh Laryngoscope Set

With Battery Handle Ref:- AN-890-01 and 3 Blades Ref:- AN-710-01 to AN-710-03



Catalog #	Size
AN-701-00	Standard



MaxBright™ LED Fibre Optic McIntosh Laryngoscope Set

With Battery Handle Ref:- AN-890-01 and 4 Blades Ref:- AN-710-01 to AN-710-04



Catalog #	Size
AN-702-00	Standard



MaxBright™ LED Fibre Optic McIntosh Laryngoscope Set

With Battery Handle Ref:- AN-890-01 and 5 Blades Ref:- AN-710-00 to AN-710-04



Catalog #	Size
AN-703-00	Standard



MaxBright™ LED Fibre Optic McIntosh Laryngoscope Blade

Fig. 0, For Babies



Catalog #	Blade Length, Fig. Usage
AN-710-00	55 mm, Fig. 0, For Babies
AN-710-01	70 mm, Fig. 1, For Children
AN-710-02	80 mm, Fig. 2, For Adolescents
AN-710-03	105 mm, Fig. 3, For Women
AN-710-04	130 mm, Fig. 4, For Men



Laryngoscopes and Accessories
 Laryngoskope und Zubehör
 Laringoscopios y accesorios
 Laryngoscopes et accessoires
 Laringoscopi ed accessori

MaxBright™ Fibre Optic Miller-Baby Laryngoscope Set

With Battery Handle Ref:- AN-890-01 and 2 Blades Ref:- AN-810-00 to AN-810-01



Catalog #	Size
AN-800-00	Standard



MaxBright™ Fibre Optic Miller Laryngoscope Set

With Battery Handle Ref:- AN-890-01 and 3 Blades Ref:- AN-810-01 to AN-810-03



Catalog #	Size
AN-801-00	Standard



MaxBright™ Fibre Optic Miller Laryngoscope Set

With Battery Handle Ref:- AN-890-01 and 4 Blades Ref:- AN-810-01 to AN-810-04



Catalog #	Size
AN-802-00	Standard



MaxBright™ Fibre Optic Miller Laryngoscope Set

With Battery Handle Ref:- AN-890-01 and 5 Blades Ref:- AN-810-00 to AN-810-04



Catalog #	Size
AN-803-00	Standard



MaxBright™ Fibre Optic Miller Laryngoscope Blade

Fig. 0, For Babies



Catalog #	Blade Length, Fig, Usage
AN-810-00	55 mm, Fig. 0, For Babies
AN-810-01	80 mm, Fig. 1, For Children
AN-810-02	130 mm, Fig. 2, For Adolescents
AN-810-03	170 mm, Fig. 3, For Women
AN-810-04	180 mm, Fig. 4, For Men



Laryngoscopes and Accessories
 Laryngoskope und Zubehör
 Laringoscopios y accesorios
 Laryngoscopes et accessoires
 Laringoscopi ed accessori

MaxBright™ Fibre Optic Battery Handle
 With 2.5 Volts LED Bulb

MAXBright™

Catalog #	Size
AN-890-01	Standard



MaxBright™ Fibre Optic Battery Handle
 Slim Profile, With 2.5 Volts LED Bulb

MAXBright™

Catalog #	Size
AN-892-02	Standard



MaxBright™ LED Fibre Optic Spare Bulb

MAXBright™

Catalog #	Power Rating
AN-894-01	2.5 V

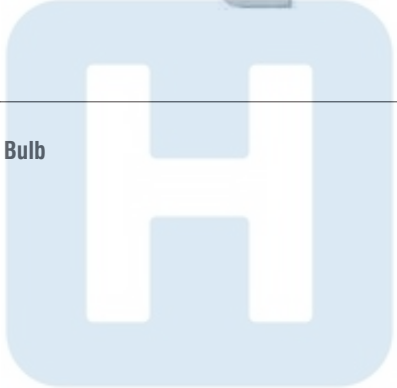

HOSPITA®

ALWAYS THE BEST

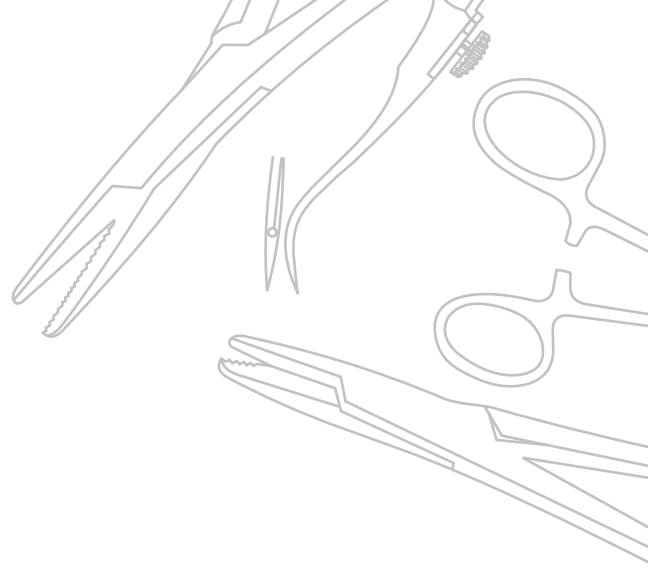

SU



SUTURE

Hospita offers an entire range of instruments for effortless wound closure ranging from needle holders, micro needle holders, ligature needles and many more. Our complete range of high quality suture instruments at your disposal ensures a perfect suture every time

Our Suture instruments are produced using latest technology to provide outstanding functionality. The diamond dust  coating or tungsten carbide **ULTRA Grip X** which we use on our forceps and needle holders not only provides a safe grip on tissues and suture material, but also ensure high wear resistance in instruments jaws.



Naht

Sutura

Suture

Sutura

Needle Holders
 Nadelhalter
 Porta-agujas
 Porte-aiguilles
 Portaghi

Derf Needle Holder
 One Fenestrated Jaw

Catalog #	Size
SU-010-12	12 cm (4 ¾")



Converse Needle Holder
 Jaw With Longitudinal Serrations

Catalog #	Size
SU-012-12	13 cm (5")



Collier Needle Holder
 One Grooved Jaws

Catalog #	Size
SU-016-12	12.5 cm (5")



Webster Needle Holder
 Smooth Jaws

Catalog #	Size
SU-020-13	13 cm (5")



Halsey Needle Holder
 Smooth Jaws

Catalog #	Size
SU-024-13	13.5 cm (5 ¼")



INCHES
 MILLIMETERS

Needle Holders
Nadelhalter
Porta-agujas
Porte-aiguilles
Portaghi

SU

SUTURE

Halsey Needle Holder
Serrated Jaws



Catalog #	Size
SU-026-13	13.5 cm (5 1/4")

Kilner Needle Holder

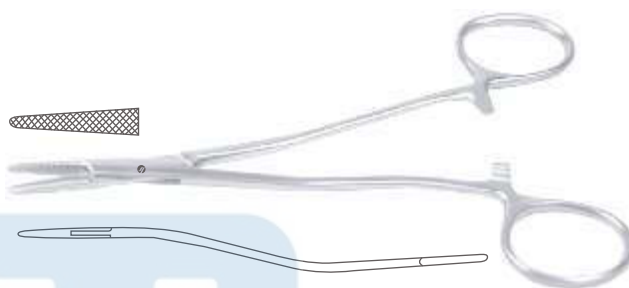

Catalog #	Size
SU-029-13	13.5 cm (5 1/4")

Neivert Needle Holder
Smooth Jaws With Special Groove

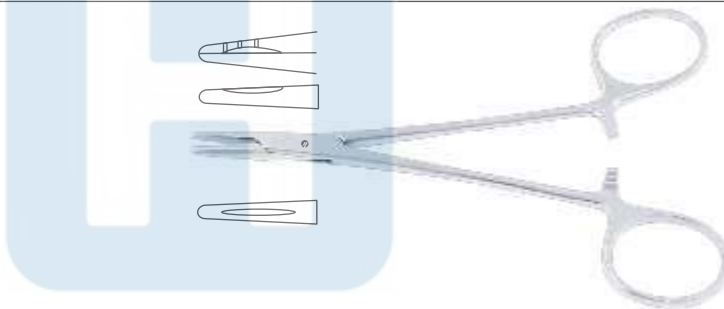

Catalog #	Size
SU-032-13	12.5 cm (5")

Doyen Needle Holder



Catalog #	Size
SU-034-13	12.5 cm (5")

Hegar-Baumgartner Needle Holder



Catalog #	Size
SU-038-14	14.5 cm (5 3/4")

Needle Holders
 Nadelhalter
 Porta-agujas
 Porte-aiguilles
 Portaghi

Brown Needle Holder
 Heavy Pattern



Catalog #	Size
SU-040-13	13 cm (5")
SU-040-18	18 cm (7")

Lawrence Needle Holder



Catalog #	Size
SU-042-15	15 cm (6")

Crile-Murray Needle Holder
 Slender Pattern



Catalog #	Size
SU-046-15	15 cm (6")

Crile-Wood Needle Holder



Catalog #	Size
SU-050-15	15 cm (6")
SU-050-18	18 cm (7")
SU-050-20	20 cm (8")

Adson Needle Holder
 One Fenestrated Jaw



Catalog #	Size
SU-052-18	18 cm (7")

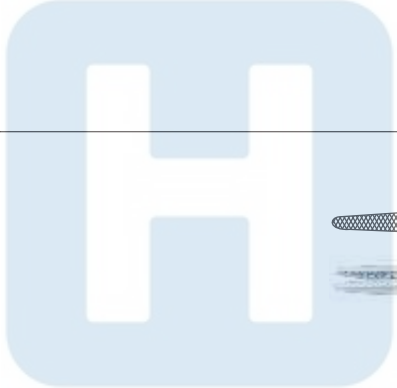

INCHES
 MILLIMETERS

Needle Holders
Nadelhalter
Porta-agujas
Porte-aiguilles
Portaghi

SU

SUTURE

Metzenbaum Needle Holder
One Grooved and Fenestrated Jaws



Catalog #	Size
SU-054-18	18.5 cm (7 1/4")

M.G. Hospital Needle Holder
Heavy Pattern



Catalog #	Size
SU-056-17	17.5 cm (7")

Mayo-Hegar Needle Holder

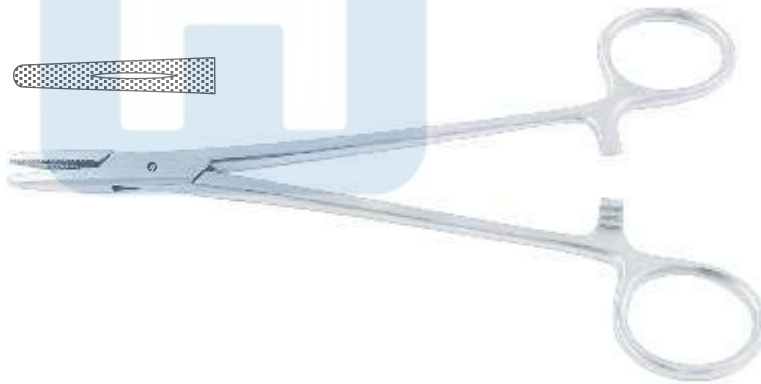

Catalog #	Size
SU-060-14	14.5 cm (5 3/4")
SU-060-16	16 cm (6 1/4")
SU-060-18	18.5 cm (7 1/4")
SU-060-20	20.5 cm (8")
SU-060-24	24 cm (9 1/2")
SU-060-26	26.5 cm (10 1/2")
SU-060-30	30.5 cm (12")

Mayo-Hegar (Delicate) Needle Holder
Slender Pattern



Catalog #	Size
SU-062-16	16 cm (6 1/4")
SU-062-18	18.5 cm (7 1/4")
SU-062-20	20.5 cm (8")

Needle Holders
 Nadelhalter
 Porta-agujas
 Porte-aiguilles
 Portaghi

Sarot Needle Holder



Catalog #	Size
SU-068-18	18 cm (7")
SU-068-26	25.5 cm (10")

Heaney Needle Holder



Catalog #	Size
SU-070-21	20.5 cm (8")

Jameson Needle Holder



Catalog #	Size
SU-072-23	23.5 cm (9 1/4")

Masson Needle Holder



Catalog #	Size
SU-074-27	26.5 cm (10 1/2")

Masson-Luethy Needle Holder



Catalog #	Size
SU-077-26	25.5 cm (10")

Needle Holders
Nadelhalter
Porta-agujas
Porte-aiguilles
Portaghi

SU

SUTURE

Finochietto Needle Holder



Catalog #	Size
SU-079-27	26.5 cm (10 1/2")

Wangensteen Needle Holder



Catalog #	Size
SU-082-27	26.5 cm (10 1/2")

Johnson Needle Holder

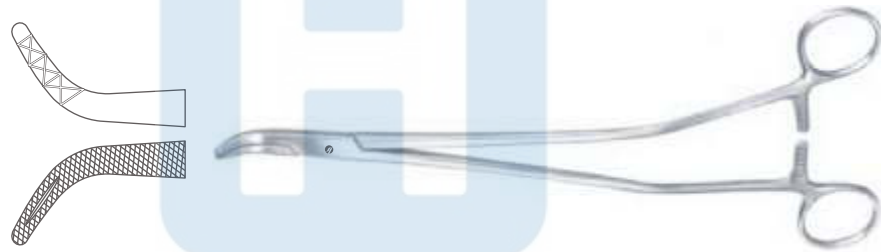

Catalog #	Size
SU-085-27	27 cm (10 3/4")

Stratte Needle Holder

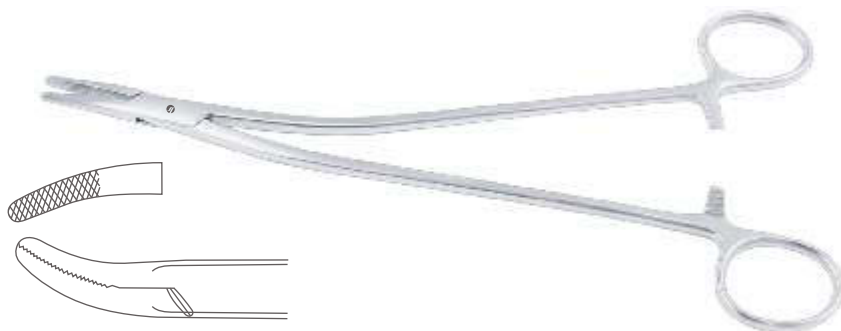

Catalog #	Size
SU-087-20	20 cm (8")
SU-087-23	23 cm (9")

Olsen-Hegar Needle Holder

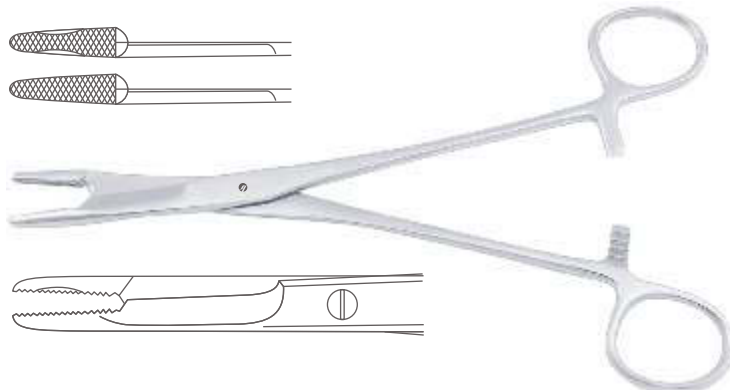

Catalog #	Size
SU-090-14	14 cm (5 1/2")
SU-090-18	18.5 cm (7 1/4")

Needle Holders
 Nadelhalter
 Porta-agujas
 Porte-aiguilles
 Portaghi

Gillies Needle Holder

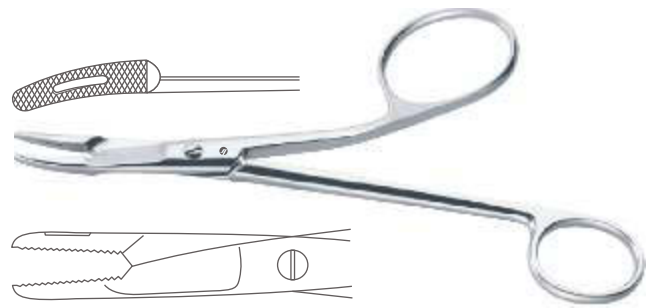

Catalog #	Size
SU-094-16	16 cm (6 1/4")

Mathieu Needle Holder



Catalog #	Size
SU-100-14	14 cm (5 1/2")
SU-100-17	17 cm (6 3/4")
SU-100-20	20 cm (8")

Mathieu (Delicate) Needle Holder



Catalog #	Size
SU-102-14	14 cm (5 1/2")
SU-102-17	16.5 cm (6 1/2")

Lichtenberg Needle Holder



Catalog #	Size
SU-110-20	20 cm (8")
SU-110-25	25 cm (9 3/4")

Zweifel Needle Holder



Catalog #	Size
SU-120-20	20 cm (8")
SU-120-23	23 cm (9")

Needle Holders
Nadelhalter
Porta-agujas
Porte-aiguilles
Portaghi

SU

SUTURE

Hoesel Needle Holder



Catalog #	Size
SU-124-25	25 cm (9 3/4")

Crile Needle Holder



Catalog #	Size
SU-130-15	15 cm (6")

Toennis Needle Holder



Catalog #	Size
SU-134-18	18.5 cm (7 1/4")

Langenbeck Needle Holder



Catalog #	Size
SU-140-16	16 cm (6 1/4")
SU-140-18	18 cm (7")
SU-140-20	20 cm (8")

McPherson Micro Needle Holder

Straight, Very Delicate, Without Lock



Catalog #	Size
SU-200-10	10 cm (4")

Micro Needle Holders
 Mikro-Nadelhalter
 Micro Porta-agujas
 Micro porte-aiguilles
 Micro Portaghi

McPherson Micro Needle Holder
 Curved, Very Delicate, Without Lock



Catalog #	Size
SU-201-10	10 cm (4")

McPherson Micro Needle Holder
 Straight, Very Delicate, With Lock



Catalog #	Size
SU-202-10	10 cm (4")

McPherson Micro Needle Holder
 Curved, Very Delicate, With Lock



Catalog #	Size
SU-203-10	10 cm (4")

Castroviejo Micro Needle Holder
 Straight, Delicate



Catalog #	Size
SU-210-14	14 cm (5 1/2")

Castroviejo Micro Needle Holder
 Curved, Delicate



Catalog #	Size
SU-211-14	14 cm (5 1/2")

Micro Needle Holders
 Mikro-Nadelhalter
 Micro Porta-agujas
 Micro porte-aiguilles
 Micro Portaghi

Castroviejo Micro Needle Holder
 Straight, Delicate, With Lock



Catalog #	Size
SU-212-14	14 cm (5 1/2")

Castroviejo Micro Needle Holder
 Curved, Delicate, With Lock



Catalog #	Size
SU-213-14	14 cm (5 1/2")

Castroviejo Micro Needle Holder
 Straight, Standard, Without Lock



Catalog #	Size
SU-220-14	14 cm (5 1/2")

Castroviejo Micro Needle Holder
 Curved, Standard, Without Lock



Catalog #	Size
SU-221-14	14 cm (5 1/2")

Castroviejo Micro Needle Holder
 Straight, Standard, With Lock



Catalog #	Size
SU-222-14	14 cm (5 1/2")

Micro Needle Holders
 Mikro-Nadelhalter
 Micro Porta-agujas
 Micro porte-aiguilles
 Micro Portaghi

Castroviejo Micro Needle Holder
 Curved, Standard, With Lock



Catalog #	Size
SU-223-14	14 cm (5 1/2")

Jacobson Micro Needle Holder
 Straight, Without Lock



Catalog #	Size
SU-230-18	18.5 cm (7 1/4")

Jacobson Micro Needle Holder
 Straight, With Lock



Catalog #	Size
SU-231-18	18.5 cm (7 1/4")

Micro Needle Holder
 Straight, With Lock



Catalog #	Size
SU-234-21	21 cm (8 1/4")

Yasargil Micro Needle Holder
 Straight



Catalog #	Size
SU-238-16	16 cm (6 1/4")

Micro Needle Holders
 Mikro-Nadelhalter
 Micro Porta-agujas
 Micro porte-aiguilles
 Micro Portaghi

Yasargil Micro Needle Holder
 Curved



Catalog #	Size
SU-239-16	16 cm (6 1/4")

Kalt Micro Needle Holder
 Straight, With Lock



Catalog #	Size
SU-246-14	13.5 cm (5 1/4")

Arruga Micro Needle Holder
 Straight, With Lock

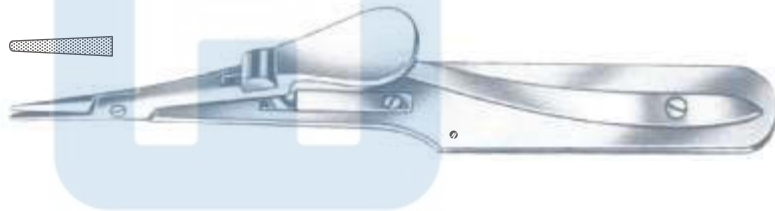

Catalog #	Size
SU-250-14	13.5 cm (5 1/4")

Arruga Micro Needle Holder
 Curved, With Lock



Catalog #	Size
SU-251-14	13.5 cm (5 1/4")

Castroviejo Micro Needle Holder
 Straight, With Lock



Catalog #	Size
SU-260-13	13 cm (5")

Micro Needle Holders
 Mikro-Nadelhalter
 Micro Porta-agujas
 Micro porte-aiguilles
 Micro Portaghi

Castroviejo Micro Needle Holder
 Curved, With Lock



Catalog #	Size
SU-261-13	13 cm (5")

Arruga Needle Holder
 Straight, With Ratchet



Catalog #	Size
SU-266-16	16 cm (6 1/4")

Arruga Needle Holder
 Curved, With Ratchet



Catalog #	Size
SU-267-16	16 cm (6 1/4")

Micro Needle Holder
 Curved, Bayonet Shaped, Smooth Jaws



Catalog #	Size
SU-271-16	16 cm (6 1/4")

Micro Needle Holder
 Straight, Bayonet Shaped, Smooth Jaws



Catalog #	Size
SU-274-23	23 cm (9")

Micro Needle Holders
 Mikro-Nadelhalter
 Micro Porta-agujas
 Micro porte-aiguilles
 Micro Portaghi

Micro Needle Holder

Curved, Bayonet Shaped, Smooth Jaws



Catalog #	Size
SU-275-23	23 cm (9")

Micro Needle Holder

Curved, Bayonet Shaped, Smooth Jaws



Catalog #	Size
SU-277-19	19 cm (7 1/2")

Yasargil Micro Needle Holder

Straight, Bayonet Shaped, Smooth Jaws



Catalog #	Size
SU-280-20	20 cm (8")
SU-280-23	23 cm (9")

Yasargil Micro Needle Holder

Curved, Bayonet Shaped, Smooth Jaws



Catalog #	Size
SU-281-20	20 cm (8")
SU-281-23	23 cm (9")

Barraquer-Troutman Micro Needle Holder

Straight, Extra Delicate, Round Handle



Catalog #	Size
SU-300-10	10 cm (4")

Micro Needle Holders
 Mikro-Nadelhalter
 Micro Porta-agujas
 Micro porte-aiguilles
 Micro Portaghi

Barraquer-Troutman Micro Needle Holder
 Curved, Extra Delicate, Round Handle



Catalog #	Size
SU-301-10	10.5 cm (4")

Barraquer-Troutman Micro Needle Holder
 Straight, Very Delicate, Round Handle, With Lock



Catalog #	Size
SU-310-10	10.5 cm (4")
SU-310-11	11.5 cm (4½")

Barraquer-Troutman Micro Needle Holder
 Curved, Very Delicate, Round Handle, With Lock



Catalog #	Size
SU-311-10	10.5 cm (4")
SU-311-11	11.5 cm (4 ½")

Barraquer Micro Needle Holder
 Curved, Delicate, Round Handle



Catalog #	Size
SU-313-11	11.5 cm (4 ½")

Barraquer Micro Needle Holder
 Curved, Delicate, Round Handle, With Lock



Catalog #	Size
SU-315-11	11.5 cm (4 ½")

Micro Needle Holders
 Mikro-Nadelhalter
 Micro Porta-agujas
 Micro porte-aiguilles
 Micro Portaghi

Titan Barraquer Micro Needle Holder

Curved, Delicate, Round Handle, With Lock, Titanium

Catalog #	Size
SU-315-11 T	11.5 cm (4 1/2")



Barraquer Micro Needle Holder

Straight, Very Delicate, Round Handle

Catalog #	Size
SU-320-13	13 cm (5")



Barraquer Micro Needle Holder

Curved, Very Delicate, Round Handle

Catalog #	Size
SU-321-13	13 cm (5")

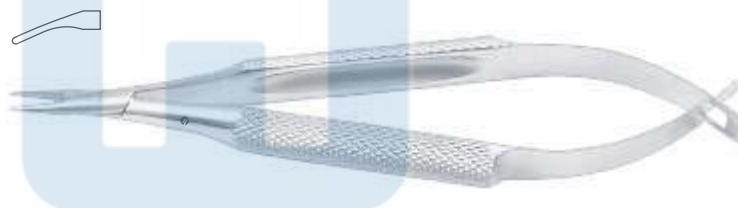

Barraquer Micro Needle Holder

Straight, Very Delicate, Round Handle, With Lock

Catalog #	Size
SU-322-13	13 cm (5")



Barraquer Micro Needle Holder

Curved, Very Delicate, Round Handle, With Lock

Catalog #	Size
SU-323-13	13 cm (5")



Micro Needle Holders
 Mikro-Nadelhalter
 Micro Porta-agujas
 Micro porte-aiguilles
 Micro Portaghi

Barraquer Micro Needle Holder
 Curved, Very Delicate, Round Handle



Catalog #	Size
SU-331-14	14 cm (5 1/2")

Barraquer Micro Needle Holder
 Curved, Very Delicate, Round Handle, Titanium



Catalog #	Size
SU-331-14 T	14 cm (5 1/2")

Barraquer Micro Needle Holder
 Curved, Very Delicate, Round Handle, With Lock



Catalog #	Size
SU-333-14	14 cm (5 1/2")

Barraquer Micro Needle Holder
 Curved, Very Delicate, Round Handle, With Lock, Titanium



Catalog #	Size
SU-333-14 T	14 cm (5 1/2")

Troutman Micro Needle Holder
 Strongly Curved, Delicate, Round Handle



Catalog #	Size
SU-341-12	12 cm (4 3/4")

Micro Needle Holders
 Mikro-Nadelhalter
 Micro Porta-agujas
 Micro porte-aiguilles
 Micro Portaghi

Troutman Micro Needle Holder

Strongly Curved, Delicate, Round Handle, With Lock



Catalog #	Size
SU-343-12	12 cm (4 3/4")

Reill Micro Needle Holder

Straight



Catalog #	Size
SU-350-15	15 cm (6")

Reill Micro Needle Holder

Curved



Catalog #	Size
SU-351-15	15 cm (6")

Micro Needle Holder

Straight, With Lock



Catalog #	Size
SU-352-15	15 cm (6")

Micro Needle Holder

Curved, With Lock



Catalog #	Size
SU-353-15	15 cm (6")

Micro Needle Holders
 Mikro-Nadelhalter
 Micro Porta-agujas
 Micro porte-aiguilles
 Micro Portaghi

Micro Needle Holder
 Straight



Catalog #	Size
SU-354-18	18.5 cm (7 1/4")

Micro Needle Holder
 Curved



Catalog #	Size
SU-355-18	18.5 cm (7 1/4")

Micro Needle Holder
 Straight, With Lock



Catalog #	Size
SU-356-18	18.5 cm (7 1/4")

Micro Needle Holder
 Curved, With Lock



Catalog #	Size
SU-357-18	18.5 cm (7 1/4")

Micro Needle Holder
 Straight, With Lock



Catalog #	Size
SU-360-20	20 cm (8")

Micro Needle Holders
Mikro-Nadelhalter
Micro Porta-agujas
Micro porte-aiguilles
Micro Portaghi

Micro Needle Holder
Straight, Delicate, With Lock

Catalog #	Size
SU-362-23	23 cm (9")



Diam-n-Dust™ Castroviejo Micro Needle Holder
Straight, Extra Delicate



Catalog #	Size
SU-400-14	14 cm (5 1/2")



Diam-n-Dust™ Castroviejo Micro Needle Holder
Curved, Extra Delicate



Catalog #	Size
SU-401-14	14 cm (5 1/2")



Diam-n-Dust™ Castroviejo Micro Needle Holder
Straight, Extra Delicate, With Lock



Catalog #	Size
SU-402-14	14 cm (5 1/2")



Diam-n-Dust™ Castroviejo Micro Needle Holder
Curved, Extra Delicate, With Lock

Catalog #	Size
SU-403-14	14 cm (5 1/2")



Micro Needle Holders
 Mikro-Nadelhalter
 Micro Porta-agujas
 Micro porte-aiguilles
 Micro Portaghi

Diam-n-Dust™ Castroviejo Micro Needle Holder
 Straight, Very Delicate



Catalog #	Size
SU-404-14	14 cm (5 1/2")



Diam-n-Dust™ Castroviejo Micro Needle Holder
 Curved, Very Delicate



Catalog #	Size
SU-405-14	14 cm (5 1/2")



Diam-n-Dust™ Castroviejo Micro Needle Holder
 Straight, Very Delicate, With Lock



Catalog #	Size
SU-406-14	14 cm (5 1/2")



Diam-n-Dust™ Castroviejo Micro Needle Holder
 Curved, Very Delicate, With Lock



Catalog #	Size
SU-407-14	14 cm (5 1/2")



Diam-n-Dust™ Castroviejo Micro Needle Holder
 Straight, Delicate



Catalog #	Size
SU-410-18	18 cm (7")



Micro Needle Holders
Mikro-Nadelhalter
Micro Porta-agujas
Micro porte-aiguilles
Micro Portaghi

Diam-n-Dust™ Castroviejo Micro Needle Holder
Curved, Delicate



Catalog #	Size
SU-411-18	18 cm (7")

Diam-n-Dust™ Castroviejo Micro Needle Holder
Straight, Delicate, With Lock



Catalog #	Size
SU-412-18	18 cm (7")

Diam-n-Dust™ Castroviejo Micro Needle Holder
Curved, Delicate, With Lock



Catalog #	Size
SU-413-18	18 cm (7")

Diam-n-Dust™ Micro Needle Holder
Straight, Without Lock



Catalog #	Size
SU-420-14	14 cm (5 1/2")
SU-420-18	18 cm (7")
SU-420-21	21 cm (8 1/4")
SU-420-23	23 cm (9")

Diam-n-Dust™ Micro Needle Holder
Straight, With Lock



Catalog #	Size
SU-422-14	14 cm (5 1/2")
SU-422-18	18 cm (7")
SU-422-21	21 cm (8 1/4")
SU-422-23	23 cm (9")

Micro Needle Holders
 Mikro-Nadelhalter
 Micro Porta-agujas
 Micro porte-aiguilles
 Micro Portaghi

Diam-n-Dust™ Micro Needle Holder
 Straight, Round Handle



DIAM-N-DUST

Catalog #	Size
SU-430-14	14 cm (5 1/2")



Diam-n-Dust™ Titan Micro Needle Holder
 Straight, Round Handle, Titanium



DIAM-N-DUST

Catalog #	Size
SU-430-14 T	14 cm (5 1/2")



Diam-n-Dust™ Micro Needle Holder
 Straight, Round Handle



DIAM-N-DUST

Catalog #	Size
SU-430-16	16 cm (6 1/4")



Diam-n-Dust™ Titan Micro Needle Holder
 Straight, Round Handle, Titanium



DIAM-N-DUST

Catalog #	Size
SU-430-16 T	16 cm (6 1/4")



Diam-n-Dust™ Micro Needle Holder
 Straight, Round Handle



DIAM-N-DUST

Catalog #	Size
SU-430-18	18 cm (7")



Micro Needle Holders
 Mikro-Nadelhalter
 Micro Porta-agujas
 Micro porte-aiguilles
 Micro Portaghi

Diam-n-Dust™ Titan Micro Needle Holder
 Straight, Round Handle, Titanium



DIA.M.-N.-DUST

Catalog #	Size
SU-430-18 T	18 cm (7")



Diam-n-Dust™ Micro Needle Holder
 Straight, Round Handle



DIA.M.-N.-DUST

Catalog #	Size
SU-430-21	21 cm (8 1/4")



Diam-n-Dust™ Titan Micro Needle Holder
 Straight, Round Handle, Titanium



DIA.M.-N.-DUST

Catalog #	Size
SU-430-21 T	21 cm (8 1/4")



Diam-n-Dust™ Micro Needle Holder
 Straight, Round Handle



DIA.M.-N.-DUST

Catalog #	Size
SU-430-23	23 cm (9")



Diam-n-Dust™ Micro Needle Holder
 Straight, Round Handle, With Lock



DIA.M.-N.-DUST

Catalog #	Size
SU-432-14	14 cm (5 1/2")



Micro Needle Holders
 Mikro-Nadelhalter
 Micro Porta-agujas
 Micro porte-aiguilles
 Micro Portaghi

Diam-n-Dust™ Titan Micro Needle Holder
 Straight, Round Handle, With Lock, Titanium



Catalog #	Size
SU-432-14 T	14 cm (5 1/2")



Diam-n-Dust™ Micro Needle Holder
 Straight, Round Handle, With Lock



Catalog #	Size
SU-432-16	16 cm (6 1/4")



Diam-n-Dust™ Titan Micro Needle Holder
 Straight, Round Handle, With Lock, Titanium



Catalog #	Size
SU-432-16 T	16 cm (6 1/4")



Diam-n-Dust™ Micro Needle Holder
 Straight, Round Handle, With Lock



Catalog #	Size
SU-432-18	18 cm (7")



Diam-n-Dust™ Titan Micro Needle Holder
 Straight, Round Handle, With Lock, Titanium



Catalog #	Size
SU-432-18 T	18 cm (7")



Micro Needle Holders
Mikro-Nadelhalter
Micro Porta-agujas
Micro porte-aiguilles
Micro Portaghi

Diam-n-Dust™ Micro Needle Holder
Straight, Round Handle, With Lock



DIA.N.-N.-DUST

Catalog #	Size
SU-432-21	21 cm (8 ¼")



Diam-n-Dust™ Titan Micro Needle Holder
Straight, Round Handle, With Lock, Titanium



DIA.N.-N.-DUST

Catalog #	Size
SU-432-21 T	21 cm (8 ¼")



Diam-n-Dust™ Micro Needle Holder
Straight, Round Handle, With Lock



DIA.N.-N.-DUST

Catalog #	Size
SU-432-23	23 cm (9")



Diam-n-Dust™ Micro Needle Holder
Straight, Heavy Pattern, Round Handle



DIA.N.-N.-DUST

Catalog #	Size
SU-440-19	19 cm (7 ½")
SU-440-23	23 cm (9")
SU-440-25	25 cm (9 ¾")



Diam-n-Dust™ Micro Needle Holder
Straight, Heavy Pattern, Round Handle, With Lock



DIA.N.-N.-DUST

Catalog #	Size
SU-442-19	19 cm (7 ½")
SU-442-23	23 cm (9")
SU-442-25	25 cm (9 ¾")



Needle Holders
Nadelhalter
Porta-agujas
Porte-aiguilles
Portaghi

Diam-n-Dust™ Castroviejo Micro Needle Holder
Straight, With Lock



Catalog #	Size
SU-450-12	12.5 cm (5")

Diam-n-Dust™ Hepp-Scheidel Micro Needle Holder
Straight, With Lock



Catalog #	Size
SU-452-18	18.5 cm (7 1/4")

Diam-n-Dust™ DeBakey Needle Holder

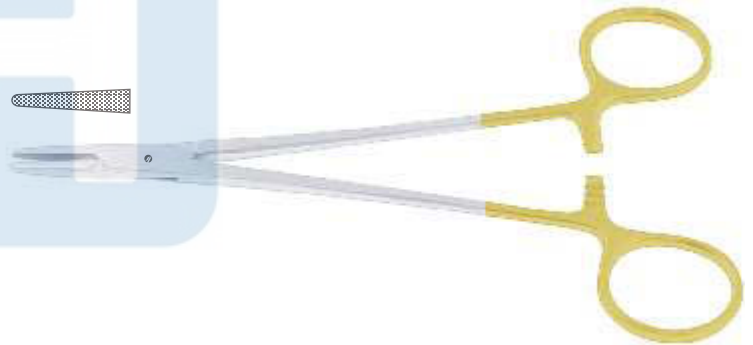

Catalog #	Size
SU-460-15	15 cm (6")
SU-460-18	18 cm (7")
SU-460-20	20 cm (8")
SU-460-23	23 cm (9")

Diam-n-Dust™ Ryder Vascular Needle Holder



Catalog #	Size
SU-470-13	13 cm (5")
SU-470-15	15 cm (6")
SU-470-18	18 cm (7")
SU-470-22	22 cm (8 3/4")
SU-470-25	25 cm (9 3/4")

Micro Needle Holders
Mikro-Nadelhalter
Micro Porta-agujas
Micro porte-aiguilles
Micro Portaghi

UltraGrip™ TC Barraquer Micro Needle Holder
Curved, Smooth Jaws, Round Handle



ULTRAGrip X™



Catalog #	Size
SU-500-13	13 cm (5")

UltraGrip™ TC Barraquer Micro Needle Holder
Curved, Smooth Jaws, Round Handle , With Lock



ULTRAGrip X™



Catalog #	Size
SU-502-13	13 cm (5")

UltraGrip™ TC Castroviejo Micro Needle Holder
Straight, With Lock



ULTRAGrip X™



Catalog #	Size
SU-510-14	14.5 cm (5 3/4")

UltraGrip™ TC Castroviejo Micro Needle Holder
Curved, With Lock



ULTRAGrip X™



Catalog #	Size
SU-511-14	14.5 cm (5 3/4")

UltraGrip™ TC Castroviejo Micro Needle Holder
Straight, Smooth Jaws, With Lock



ULTRAGrip X™



Catalog #	Size
SU-512-14	14.5 cm (5 3/4")

Micro Needle Holders
 Mikro-Nadelhalter
 Micro Porta-agujas
 Micro porte-aiguilles
 Micro Portaghi

UltraGrip™ TC Castroviejo Micro Needle Holder
 Curved, Smooth Jaws, With Lock



ULTRAGrip™



Catalog #	Size
SU-513-14	14.5 cm (5 3/4")

UltraGrip™ TC Micro Needle Holder
 Straight, With Lock



ULTRAGrip™



Catalog #	Size
SU-520-18	18 cm (7")

UltraGrip™ TC Micro Needle Holder
 Curved, With Lock



ULTRAGrip™



Catalog #	Size
SU-521-18	18 cm (7")

UltraGrip™ TC Jacobson Micro Needle Holder
 Straight, With Lock



ULTRAGrip™



Catalog #	Size
SU-530-21	21.5 cm (8 1/2")

UltraGrip™ TC Jacobson Micro Needle Holder
 Curved, With Lock



ULTRAGrip™



Catalog #	Size
SU-531-21	21.5 cm (8 1/2")

Needle Holders
Nadelhalter
Porta-agujas
Porte-aiguilles
Portaghi

SU

SUTURE

UltraGrip™ TC Castroviejo Micro Needle Holder
Smooth Jaws, With Lock

ULTRAGrip™ X™

Catalog #	Size
SU-540-13	12.5 cm (5")



UltraGrip™ TC Hepp-Scheidel Micro Needle Holder
Smooth Jaws, With Lock

ULTRAGrip™ X™

Catalog #	Size
SU-544-18	18.5 cm (7 1/4")



UltraGrip™ TC Diethrich Micro Needle Holder

ULTRAGrip™ X™

Catalog #	Size
SU-550-16	16 cm (6 1/4")
SU-550-18	18 cm (7")
SU-550-20	20 cm (8")
SU-550-23	23 cm (9")
SU-550-26	26 cm (10 1/2")

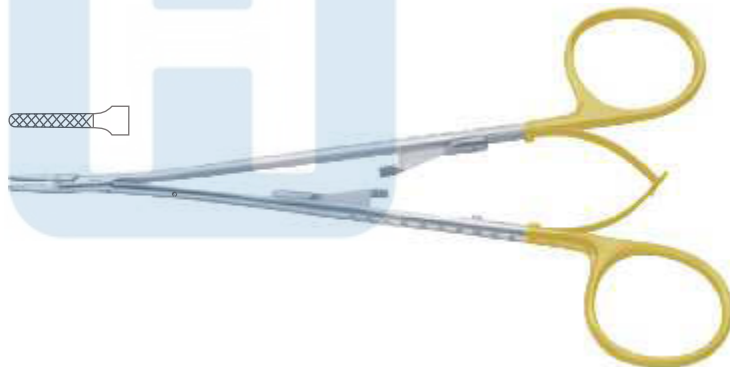

UltraGrip™ TC Arruga Needle Holder
Straight

ULTRAGrip™ X™

Catalog #	Size
SU-560-16	16 cm (6 1/4")



UltraGrip™ TC Arruga Needle Holder
Curved

Catalog #	Size
SU-561-16	16 cm (6 1/4")



Needle Holders
Nadelhalter
Porta-agujas
Porte-aiguilles
Portaghi

UltraGrip™ TC Webster Needle Holder
With Automatic Release Ratchet

ULTRAGrip X™

Catalog #	Size
SU-564-13	13 cm (5")

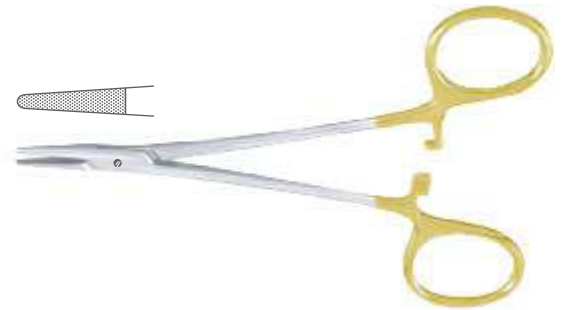

UltraGrip™ TC Crile-Wood Needle Holder
With Automatic Release Ratchet

ULTRAGrip X™

Catalog #	Size
SU-566-15	15 cm (6")

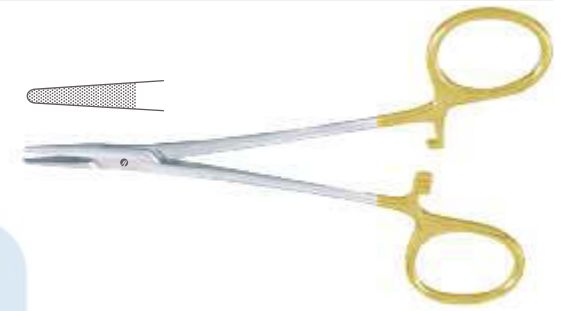

UltraGrip™ TC Webster Needle Holder
Smooth Jaws

ULTRAGrip X™

Catalog #	Size
SU-570-13	13 cm (5")

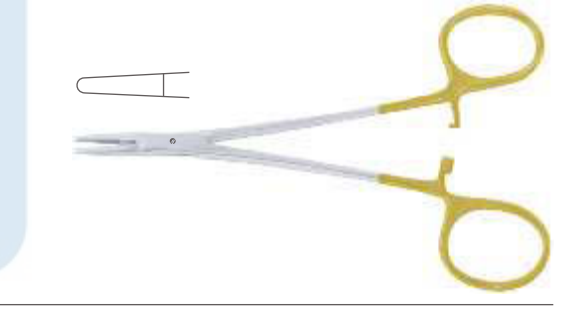

UltraGrip™ TC Kilner Needle Holder
S Shaped

ULTRAGrip X™

Catalog #	Size
SU-573-13	13 cm (5")



UltraGrip™ TC Derf Needle Holder

ULTRAGrip X™

Catalog #	Size
SU-576-12	12 cm (4 3/4")



Needle Holders
Nadelhalter
Porta-agujas
Porte-aiguilles
Portaghi

SU

SUTURE

UltraGrip™ TC Hegar-Baumgartner Needle Holder

ULTRAGripX™

Catalog #	Size
SU-580-13	13 cm (5")
SU-580-14	14.5 cm (5")



UltraGrip™ TC Halsey Needle Holder Smooth Jaw

ULTRAGripX™

Catalog #	Size
SU-584-13	13 cm (5")

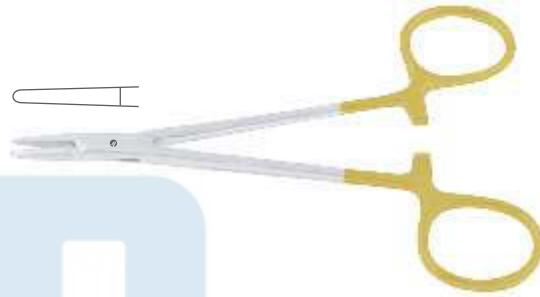

UltraGrip™ TC Halsey Needle Holder

ULTRAGripX™

Catalog #	Size
SU-586-13	13 cm (5")

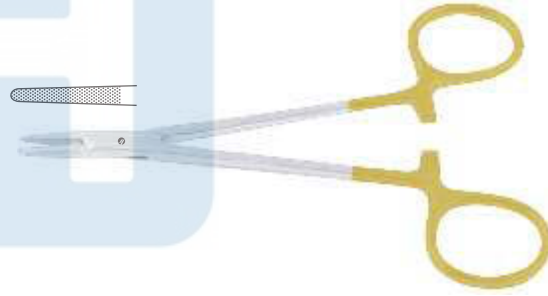

UltraGrip™ TC Webster Needle Holder Smooth Jaw

ULTRAGripX™

Catalog #	Size
SU-588-12	12 cm (4 3/4")

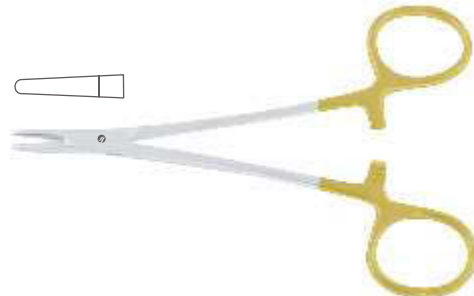

UltraGrip™ TC Converse Needle Holder

ULTRAGripX™

Catalog #	Size
SU-590-12	12.5 cm (5")

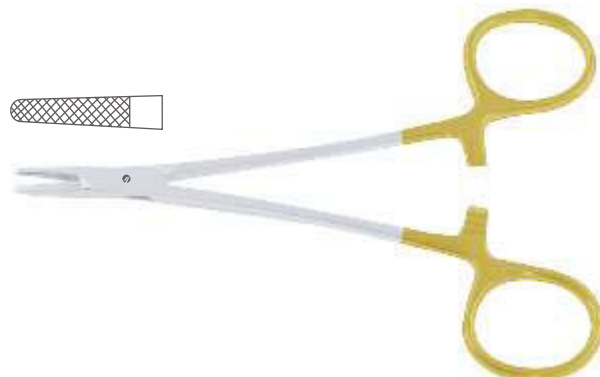

Needle Holders
Nadelhalter
Porta-agujas
Porte-aiguilles
Portaghi

UltraGrip™ TC Crile-Wood Needle Holder

ULTRAGrip™ X

Catalog #	Size
SU-594-15	15 cm (6")
SU-594-18	18 cm (7")
SU-594-20	20 cm (8")



UltraGrip™ TC Sarot Needle Holder

ULTRAGrip™ X

Catalog #	Size
SU-598-18	18 cm (7")
SU-598-20	20 cm (8")
SU-598-26	26 cm (10 1/4")

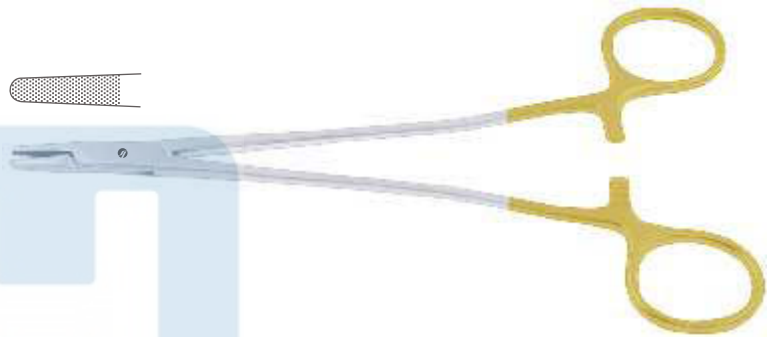

UltraGrip™ TC Mayo-Hegar Needle Holder

ULTRAGrip™ X

Catalog #	Size
SU-600-14	14.5 cm (5 3/4")
SU-600-16	16 cm (6 1/4")
SU-600-18	18 cm (7")
SU-600-20	20 cm (8")
SU-600-24	24 cm (9 1/2")
SU-600-26	26 cm (10 1/4")
SU-600-30	30 cm (11 3/4")



UltraGrip™ TC Hegar Needle Holder

ULTRAGrip™ X

Catalog #	Size
SU-602-20	20 cm (8")
SU-602-24	23.5 cm (9 1/4")



Needle Holders
Nadelhalter
Porta-agujas
Porte-aiguilles
Portaghi

SU

SUTURE

UltraGrip™ TC Heaney Needle Holder

ULTRAGripX™

Catalog #	Size
SU-605-20	20 cm (8")
SU-605-24	24 cm (9 ½")
SU-605-26	26 cm (10 ¼")



UltraGrip™ TC Bozemann Needle Holder S Shaped

ULTRAGripX™

Catalog #	Size
SU-611-20	20.5 cm (8")
SU-611-24	24 cm (9 ½")
SU-611-26	26.5 cm (10 ½")
SU-611-28	29 cm (11 ½")



UltraGrip™ TC Stratte Needle Holder

ULTRAGripX™

Catalog #	Size
SU-615-21	21 cm (8 ¼")
SU-615-23	23 cm (9")



UltraGrip™ TC Masson Needle Holder

ULTRAGripX™

Catalog #	Size
SU-620-27	26.5 cm (10 ½")



Needle Holders
Nadelhalter
Porta-agujas
Porte-aiguilles
Portaghi

UltraGrip™ TC Wangenstein Needle Holder

ULTRAGrip X™

Catalog #	Size
SU-624-27	27 cm (10 3/4")



UltraGrip™ TC Needle Holder

ULTRAGrip X™

Catalog #	Size
SU-625-27	27 cm (10 3/4")



UltraGrip™ TC Finochietto Needle Holder

ULTRAGrip X™

Catalog #	Size
SU-627-27	26.5 cm (10 1/2")



UltraGrip™ TC Naunton-Morgan Needle Holder
Compound Action

ULTRAGrip X™

Catalog #	Size
SU-630-26	26 cm (10 1/4")



UltraGrip™ TC DeBakey Needle Holder

ULTRAGrip X™

Catalog #	Size
SU-650-18	18 cm (7")
SU-650-20	20 cm (8")
SU-650-23	23 cm (9")
SU-650-26	26 cm (10 1/4")
SU-650-31	31 cm (12 1/4")



Needle Holders
Nadelhalter
Porta-agujas
Porte-aiguilles
Portaghi

SU

SUTURE

UltraGrip™ TC Ryder Needle Holder

ULTRAGripX™

Catalog #	Size
SU-660-13	12.5 cm (5")
SU-660-15	15 cm (6")
SU-660-18	18 cm (7")
SU-660-20	20 cm (8")
SU-660-23	23 cm (9")
SU-660-26	26 cm (10 ¼")



UltraGrip™ TC Ryder-Vascular Needle Holder

ULTRAGripX™

Catalog #	Size
SU-664-13	12.5 cm (5")
SU-664-15	15 cm (6")
SU-664-18	18 cm (7")
SU-664-20	20 cm (8")
SU-664-23	22.5 cm (8 ¾")
SU-664-26	26 cm (10 ¼")

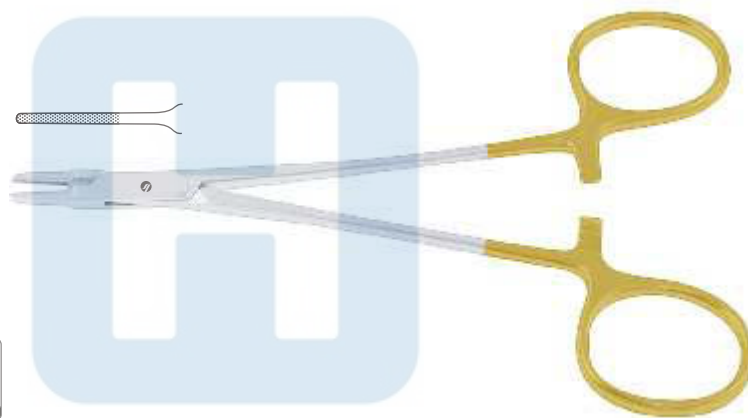
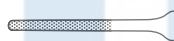

UltraGrip™ TC Martin Needle Holder

ULTRAGripX™

Catalog #	Size
SU-670-15	15 cm (6")
SU-670-17	17 cm (6 ¾")
SU-670-20	20 cm (8")

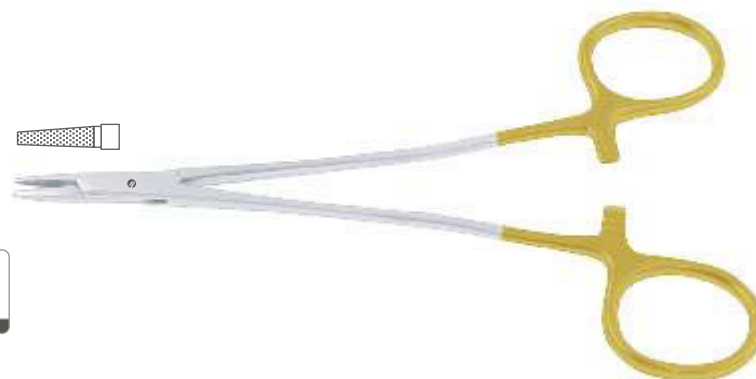

Needle Holders
Nadelhalter
Porta-agujas
Porte-aiguilles
Portaghi

UltraGrip™ TC Hegar-Vascular Needle Holder

ULTRAGrip X™

Catalog #	Size
SU-674-14	14 cm (5 1/2")
SU-674-18	18.5 cm (7 1/4")
SU-674-20	20.5 cm (8")
SU-674-23	23 cm (9")



UltraGrip™ TC Micro Vascular Needle Holder

ULTRAGrip X™

Catalog #	Size
SU-678-14	14 cm (5 1/2")
SU-678-18	18 cm (7")
SU-678-20	20 cm (8")
SU-678-23	23 cm (9")



UltraGrip™ TC Martini Needle Holder
Smooth Jaw

ULTRAGrip X™

Catalog #	Size
SU-680-14	14 cm (5 1/2")
SU-680-16	16 cm (6 1/4")
SU-680-18	18 cm (7")
SU-680-20	20 cm (8")



UltraGrip™ TC Martini Needle Holder

ULTRAGrip X™

Catalog #	Size
SU-682-14	14 cm (5 1/2")
SU-682-16	16 cm (6 1/4")
SU-682-18	18 cm (7")
SU-682-20	20 cm (8")

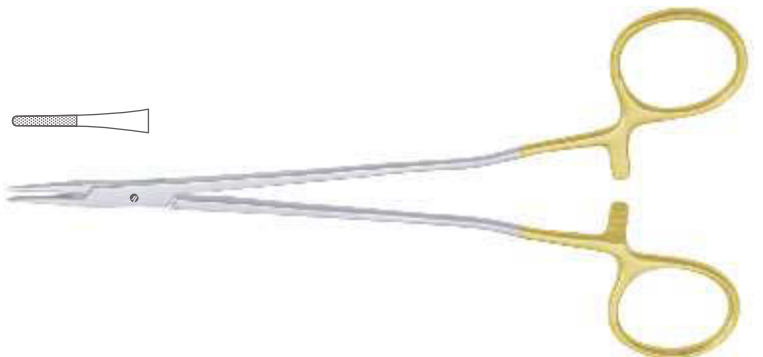

Needle Holders
Nadelhalter
Porta-agujas
Porte-aiguilles
Portaghi

SU

SUTURE

UltraGrip™ TC Olsen-Hegar Needle Holder

ULTRAGrip X™

Catalog #	Size
SU-690-14	14.5 cm (5 ¾")
SU-690-17	17 cm (6 ¾")
SU-690-18	19 cm (7 ½")



UltraGrip™ TC Foster-Gillies Needle Holder Smooth Jaws

ULTRAGrip X™

Catalog #	Size
SU-693-11	11 cm (4 ¼")



UltraGrip™ TC Gillies-Mini Needle Holder

ULTRAGrip X™

Catalog #	Size
SU-695-15	15 cm (6")

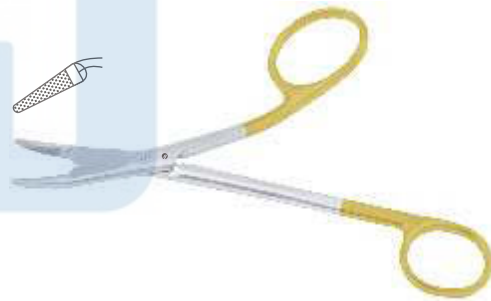

UltraGrip™ TC Gillies Needle Holder

ULTRAGrip X™

Catalog #	Size
SU-697-16	16 cm (6 ¼")



UltraGrip™ TC Mathieu Needle Holder

ULTRAGrip X™

Catalog #	Size
SU-700-14	14 cm (5 ½")
SU-700-17	17 cm (6 ¾")
SU-700-20	20 cm (8")



Needle Holders
Nadelhalter
Porta-agujas
Porte-aiguilles
Portaghi

UltraGrip™ TC Mathieu Needle Holder

ULTRAGrip X™

Catalog #	Size
SU-702-14	14 cm (5 ½")
SU-702-17	17 cm (6 ¾")
SU-702-20	20 cm (8")



UltraGrip™ TC Mathieu Needle Holder With Interior Ratchet

ULTRAGrip X™

Catalog #	Size
SU-706-17	17 cm (6 ¾")
SU-706-20	20 cm (8")
SU-706-23	23 cm (9")



UltraGrip™ TC Lichtenberg Needle Holder

ULTRAGrip X™

Catalog #	Size
SU-710-20	20 cm (8")



UltraGrip™ TC Zweifel Needle Holder With Hinged Ratchet

ULTRAGrip X™

Catalog #	Size
SU-720-20	20.5 cm (8")
SU-720-23	23 cm (9")



Needle Holder, Ligature Needles
 Nadelhalter, Unterbindungsnadeln
 Porta-agujas, Agujas para ligaduras
 Porte-aiguilles, Aiguilles à ligatures
 Portaghi, Aghi per legatura

UltraGrip™ TC Toennis Needle Holder

ULTRAGrip™ X

Catalog #	Size
SU-730-18	18.5 cm (7 1/4")



UltraGrip™ TC Langenbeck Needle Holder

ULTRAGrip™ X

Catalog #	Size
SU-740-18	18 cm (7")
SU-740-20	20.5 cm (8")
SU-740-23	23 cm (9")



Reverdin Ligature Needle Short

Catalog #	Size
SU-801-15	14.5 cm (5 3/4")

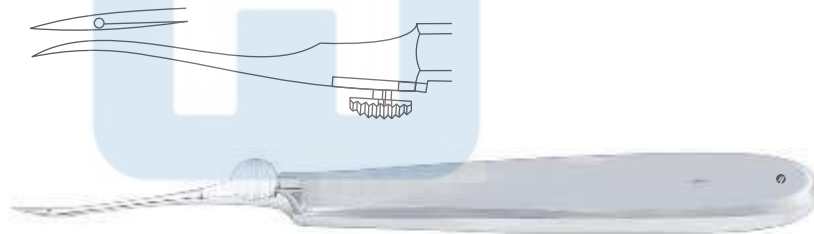

Reverdin Ligature Needle Short

Catalog #	Size
SU-803-15	14.5 cm (5 3/4")

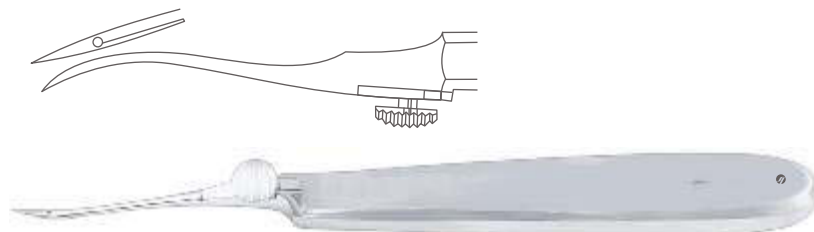

Reverdin Ligature Needle Short

Catalog #	Size
SU-805-15	14.5 cm (5 3/4")

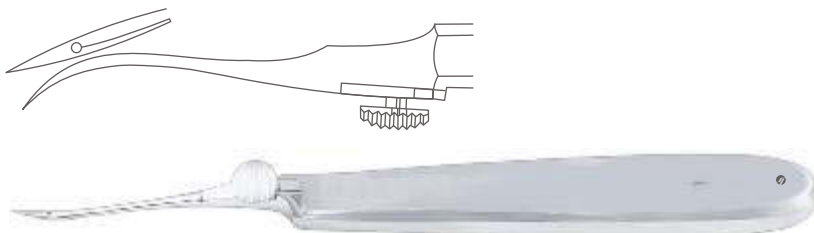

Ligature Needles
 Unterbindungsnadeln
 Agujas para ligaduras
 Aiguilles à ligatures
 Aghi per legatura

Reverdin Ligature Needle
 Short

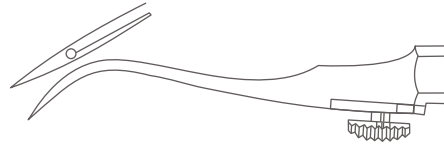

Catalog #	Size
SU-807-15	14.5 cm (5 3/4")

Reverdin Ligature Needle
 Medium



Catalog #	Size
SU-811-19	19.5 cm (7 3/4")

Reverdin Ligature Needle
 Medium

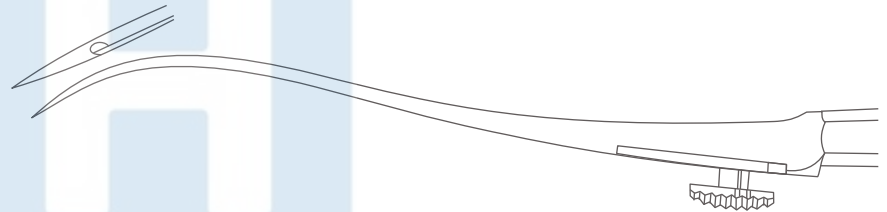

Catalog #	Size
SU-813-19	19.5 cm (7 3/4")

Reverdin Ligature Needle
 Medium

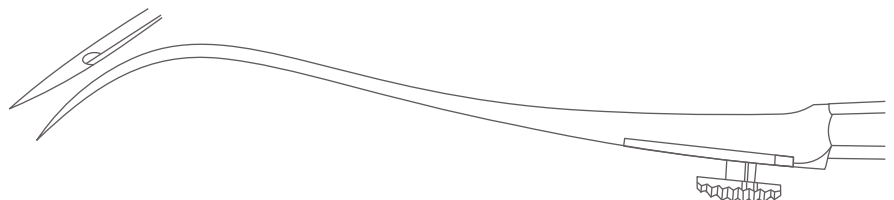

Catalog #	Size
SU-815-19	19.5 cm (7 3/4")

Reverdin Ligature Needle
 Medium

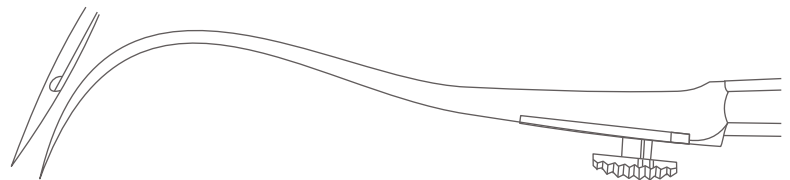

Catalog #	Size
SU-817-19	19.5 cm (7 3/4")

INCHES
 MILLIMETERS

Ligature Needles
 Unterbindungsnadeln
 Aguja para ligaduras
 Aiguilles à ligatures
 Aghi per legatura

Reverdin Ligature Needle
 Long

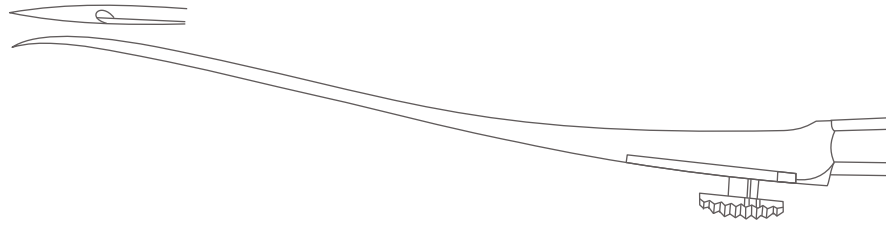

Catalog #	Size
SU-821-23	23 cm (9")



Reverdin Ligature Needle
 Long

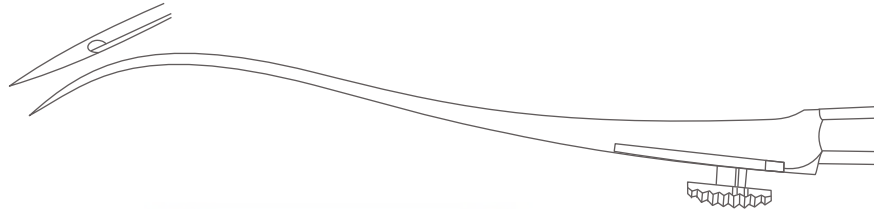

Catalog #	Size
SU-823-23	23 cm (9")



Reverdin Ligature Needle
 Long

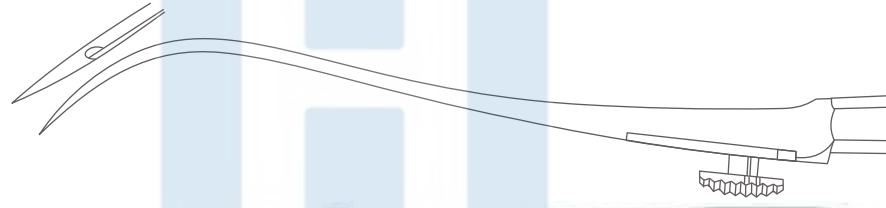

Catalog #	Size
SU-825-23	23 cm (9")



Reverdin Ligature Needle
 Long

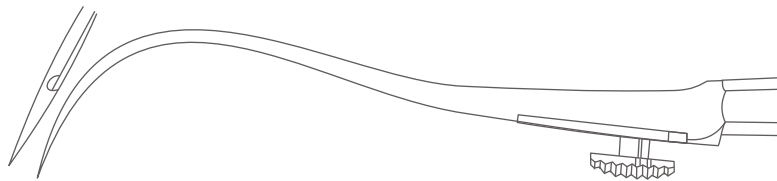

Catalog #	Size
SU-827-23	23 cm (9")



Young Ligature Needle Holder Complete
 With Needle Ref: SU-831-01



Catalog #	Size
SU-831-00	24.5 cm (9 3/4")

Ligature Needles
 Unterbindungsnadeln
 Aguja para ligaduras
 Aiguilles à ligatures
 Aghi per legatura

Young Ligature Needle Only
 Fig. 1

Catalog #	Size
SU-831-01	N/A



Young Ligature Needle Only
 Fig. 2

Catalog #	Size
SU-831-02	N/A

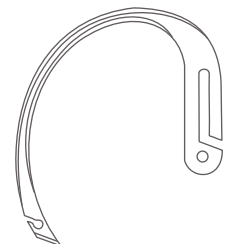

Young Ligature Needle Only
 Fig. 3

Catalog #	Size
SU-831-03	N/A

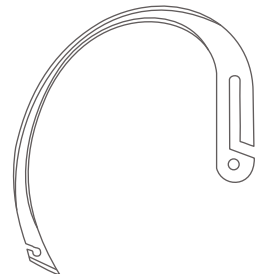

Schmieden-Dick Ligature Needle
 Malleable

Catalog #	Size
SU-835-32	29 cm (11 1/2")

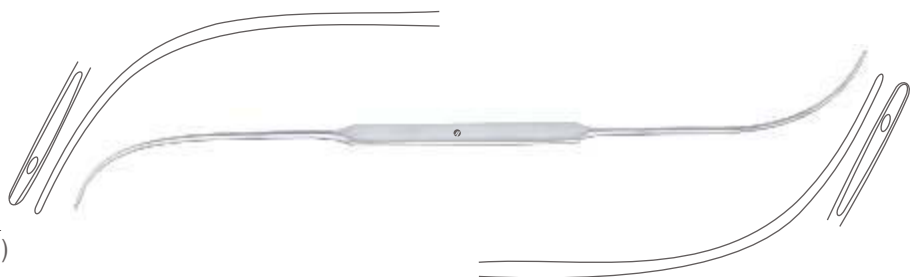

Schmieden Ligature Needle

Catalog #	Size
SU-837-21	24 cm (9 1/2")



INCHES
 MILLIMETERS

Ligature Needles
 Unterbindungsnadeln
 Agujas para ligaduras
 Aiguilles à ligatures
 Aghi per legatura

Ligature Needle
 Malleable



Catalog #	Size
SU-841-20	20.5 cm (8")

Jonesco Ligature Needle



Catalog #	Size
SU-843-18	18.5 cm (7 1/4")

Claus Van Eicken Ligature Needle

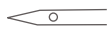

Catalog #	Size
SU-845-25	25 cm (9 3/4")

Ligature Needle

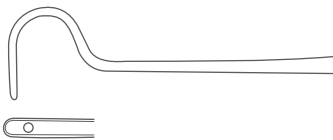

Catalog #	Size
SU-849-15	15 cm (6")

Syme Ligature Needle

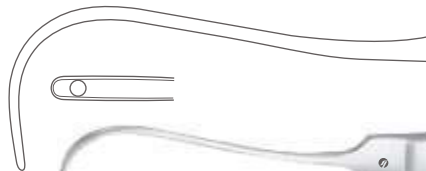

Catalog #	Size
SU-851-17	17 cm (6 3/4")

Ligature Needles
 Unterbindungsnadeln
 Agujas para ligaduras
 Aiguilles à ligatures
 Aghi per legatura

Cooper Ligature Needle

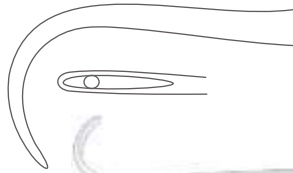

Catalog #	Size
SU-853-19	18.5 cm (7 1/4")



Kocher Ligature Needle

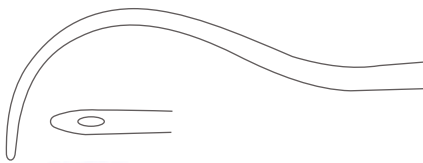

Catalog #	Size
SU-855-20	20.5 cm (8")



Kronecker Ligature Needle

Delicate For Right Hand



Catalog #	Size
SU-861-13	12.5 cm (5")



Kronecker Ligature Needle

Delicate For Left Hand



Catalog #	Size
SU-863-13	12.5 cm (5")



Deschamps Ligature Needle

Blunt For Right Hand

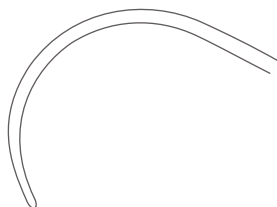

Catalog #	Size
SU-871-24	24 cm (9 1/2")



Ligature Needles
 Unterbindungsnadeln
 Agujas para ligaduras
 Aiguilles à ligatures
 Aghi per legatura

Deschamps Ligature Needle
 Blunt For Left Hand

Catalog #	Size
SU-873-24	24 cm (9 1/2")



Deschamps Ligature Needle
 Blunt For Right Hand

Catalog #	Size
SU-875-20	20 cm (8")



Deschamps Ligature Needle
 Blunt For Left Hand

Catalog #	Size
SU-877-20	20 cm (8")



Deschamps Ligature Needle
 Sharp For Right Hand

Catalog #	Size
SU-879-20	20 cm (8")



Deschamps Ligature Needle
 Sharp For Left Hand

Catalog #	Size
SU-881-20	20 cm (8")



Ligature Needles
 Unterbindungsnadeln
 Agujas para ligaduras
 Aiguilles à ligatures
 Aghi per legatura

Deschamps Ligature Needle
 Blunt For Right Hand

Catalog #	Size
SU-883-21	20 cm (8")



Deschamps Ligature Needle
 Blunt For Left Hand

Catalog #	Size
SU-885-21	20 cm (8")



Deschamps Ligature Needle
 Sharp For Right Hand

Catalog #	Size
SU-887-20	20 cm (8")



Deschamps Ligature Needle
 Sharp For Left Hand

Catalog #	Size
SU-889-20	20 cm (8")



Deschamps Ligature Needle
 Sharp For Right Hand

Catalog #	Size
SU-891-21	20 cm (8")



INCHES
 MILLIMETERS

Ligature Needles
 Unterbindungsnadeln
 Agujas para ligaduras
 Aiguilles à ligatures
 Aghi per legatura

Deschamps Ligature Needle

Sharp For Left Hand



Catalog #	Size
SU-893-21	20 cm (8")

Deschamps Ligature Needle

Blunt For Right Hand



Catalog #	Size
SU-895-27	27 cm (10 3/4")

Deschamps Ligature Needle

Blunt For Left Hand

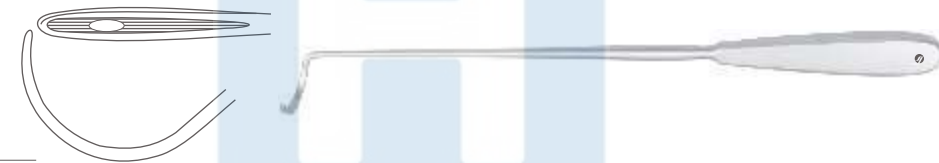

Catalog #	Size
SU-897-27	27 cm (10 3/4")

Deschamps Ligature Needle

Sharp For Right Hand



Catalog #	Size
SU-901-27	27 cm (10 3/4")

Deschamps Ligature Needle

Sharp For Left Hand



Catalog #	Size
SU-903-27	27 cm (10 3/4")

Ligature Needles
 Unterbindungsnadeln
 Agujas para ligaduras
 Aiguilles à ligatures
 Aghi per legatura

Deschamps Ligature Needle
 Blunt For Right Hand



Catalog #	Size
SU-905-28	28 cm (11")

Deschamps Ligature Needle
 Blunt For Left Hand



Catalog #	Size
SU-907-28	28 cm (11")

Deschamps Ligature Needle
 Sharp For Right Hand



Catalog #	Size
SU-911-20	20 cm (8")

Deschamps Ligature Needle
 Sharp For Left Hand



Catalog #	Size
SU-913-20	20 cm (8")

Deschamps Ligature Needle
 Blunt For Right Hand



Catalog #	Size
SU-915-20	20 cm (8")

INCHES
 MILLIMETERS

Ligature Needles
 Unterbindungsnadeln
 Agujas para ligaduras
 Aiguilles à ligatures
 Aghi per legatura

Deschamps Ligature Needle
 Blunt For Left Hand



Catalog #	Size
SU-917-20	20 cm (8")

Deschamps Ligature Needle
 Blunt For Right Hand



Catalog #	Size
SU-921-20	21 cm (8 1/4")

Deschamps Ligature Needle
 Blunt For Left Hand

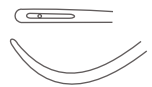

Catalog #	Size
SU-923-20	21 cm (8 1/4")

Hurd Ligature Needle
 Sharp For Right Hand

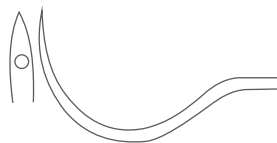

Catalog #	Size
SU-927-21	20.5 cm (8")

Hurd Ligature Needle
 Sharp For Left Hand

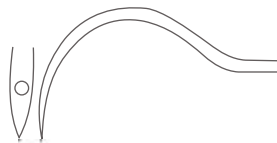

Catalog #	Size
SU-929-21	20.5 cm (8")

Ligature Needles
 Unterbindungsnadeln
 Agujas para ligaduras
 Aiguilles à ligatures
 Aghi per legatura

Brunner Ligature Needle

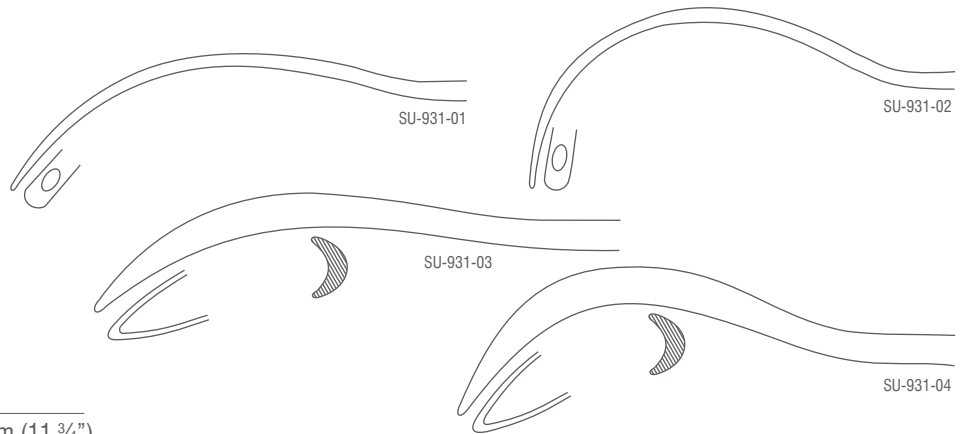

Catalog #	Size
SU-931-01	30 cm (11 3/4")
SU-931-02	30 cm (11 3/4")
SU-931-03	30 cm (11 3/4")
SU-931-04	30 cm (11 3/4")



Kirschner Ligature Needle

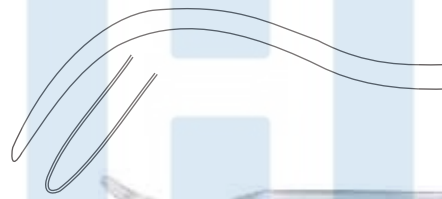

Catalog #	Size
SU-935-25	25.5 cm (10")



Ligature Needle

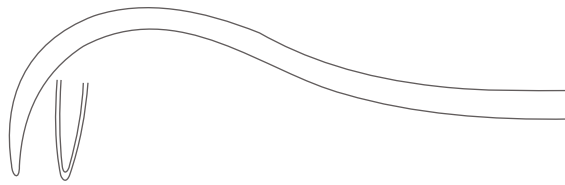

Catalog #	Size
SU-937-28	28 cm (11")



Martin Ligature Needle

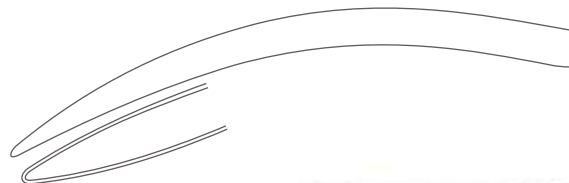

Catalog #	Size
SU-939-25	19.5 cm (7 3/4")



INCHES
 MILLIMETERS

Ligature Conductors
Führungshohlsonden
Sondas conductoras
Sondes conductrices
Sonde conduttrici

SU

SUTURE

Brunner Ligature Conductor
Ferrozell



Catalog #	Size
SU-941-18	18 cm (7")

Kirschner Ligature Conductor
Ferrozell



Catalog #	Size
SU-943-27	27 cm (10 3/4")

Ligature Conductor
Ferrozell



Catalog #	Size
SU-945-19	19 cm (7 1/2")

Ligature Conductor
Ferrozell



Catalog #	Size
SU-949-24	24 cm (9 1/2")

Schmieden Ligature Conductor

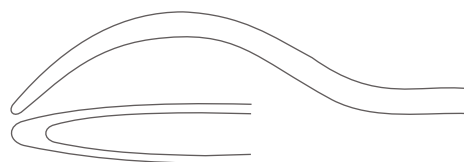

Catalog #	Size
SU-951-19	18 cm (7")

Ligature Conductors
 Führungshohlsonden
 Sondas conductoras
 Sondes conductrices
 Sonde conduttrici

Schmieden-Payr Ligature Conductor

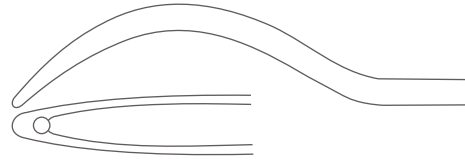

Catalog #	Size
SU-953-19	18 cm (7")

Koeing Ligature Conductor

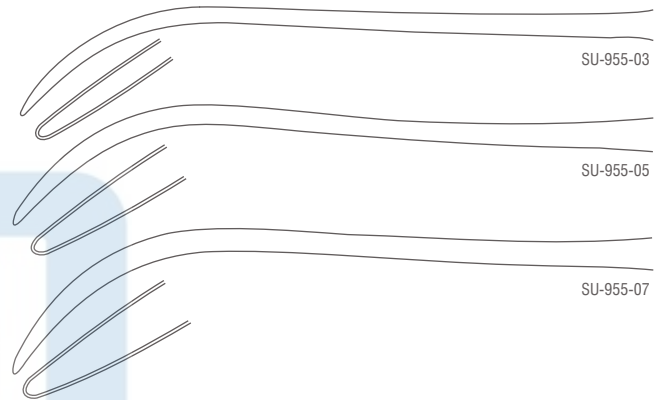

Catalog #	Size
SU-955-03	19.5 cm (7 3/4")
SU-955-05	19.5 cm (7 3/4")
SU-955-07	19.5 cm (7 3/4")

Payr Ligature Conductor

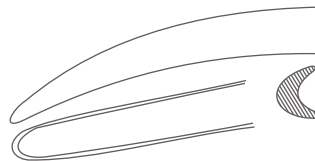

Catalog #	Size
SU-957-22	22 cm (8 3/4")

Payr Ligature Conductor

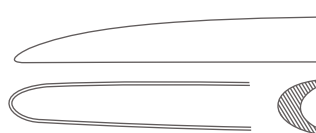

Catalog #	Size
SU-959-22	22 cm (8 3/4")

Ligature Conductors
Führungshohlsonden
Sondas conductoras
Sondes conductrices
Sonde conduttrici

SU

SUTURE

Modell Wien Ligature Catcher



Catalog #	Size
SU-961-23	23.5 cm (9 1/4")

Bozemann Knot Tier



Catalog #	Size
SU-963-21	21 cm (8 1/4")

Ligature Adjuster



Catalog #	Size
SU-965-23	23 cm (9")

Caspar Ligature Adjuster Bayonet Shaped



Catalog #	Size
SU-967-23	23 cm (9")

Millin Ligature Holding Forcep



Catalog #	Size
SU-969-24	24 cm (9 1/2")

Clip Applying Forceps
 Wundklammerpinzetten, Wundklammerzängchen
 Pinzas aplicadoras para agrafes
 Pinces à poser les agrafes
 Pinze per applicare le agrafe

Childe Approximation Forcep
 Heavy Pattern With Clip Holder

Catalog #	Size
SU-980-18	17.5 cm (7")



Michel Clip Applying Forcep

Catalog #	Size
SU-984-12	12 cm (4 3/4")



Hegenbarth Clip Applying Forcep

Catalog #	Size
SU-986-12	12 cm (4 3/4")



Wachenfeldt Clip Applying Forcep

Catalog #	Size
SU-988-12	12 cm (4 3/4")



Michel Clip Applying & Removing Forcep
 For Applying and Removal of Clips

Catalog #	Size
SU-990-12	12.5 cm (5")



Clip Applying Forceps
 Wundklammerpinzetten, Wundklammerzängchen
 Pinzas aplicadoras para agrafes
 Pincas à poser les agrafes
 Pinze per applicare le agrafe

Michel Clip Applying & Removing Forcep
 Long Jaws For Applying and Removal of Clips



Catalog #	Size
SU-992-12	13 cm (5")

Collin Clip Applying Forcep
 With Screw Lock



Catalog #	Size
SU-994-13	13 cm (5")

Richter Clip Applying Forcep
 With Screw Lock



Catalog #	Size
SU-997-14	13.5 cm (5 1/4")

Michel Suture Clips
 Pack of 1000

Catalog #	Clip Size
SU-999-01	7.5 x 1.75 mm
SU-999-02	11 x 2.0 mm
SU-999-03	12 x 3.0 mm
SU-999-04	14 x 3.0 mm
SU-999-05	16 x 3.0 mm
SU-999-06	18 x 3.0 mm
SU-999-07	20 x 3.0 mm
SU-999-08	22 x 3.0 mm

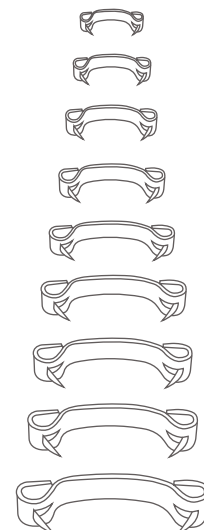

HOSPITA®

ALWAYS THE BEST

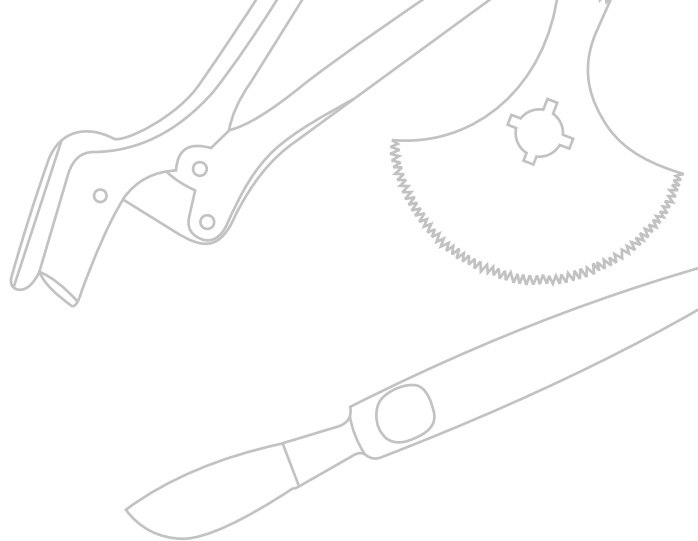

DR



DRESSING INSTRUMENTS

Hospita has developed an unbeatable reputation worldwide for the most competitively priced and high quality dressing tools on the market place. You will be pleased to note we apply the same high standards to these simple instruments as those applied to the most delicate of instruments in our range



Verband Instrumente

Vendajes Instrumentos

Pansements Instruments

Bendaggi Strumenti

Plaster Shears, Plaster Knives
 Gipsscheren, Gipsmesser
 Tijeras para yeso, Cuchillos para yeso
 Ciseaux pour plâtre, Couteaux pour plâtre
 Forbici per gesso, Coltelli per gesso

Stille Plaster of Paris Shear



Catalog #	Size
DR-100-23	23 cm (9")
DR-100-26	27 cm (10 3/4")
DR-100-37	38 cm (15")

Hopkins Plaster Knife



Catalog #	Size
DR-150-20	20 cm (8")

Esmarch Plaster Knife



Catalog #	Size
DR-156-18	18 cm (7")

Reiner Plaster Knife



Catalog #	Size
DR-160-18	18 cm (7")

Martin Plaster Knife



Catalog #	Size
DR-164-21	21 cm (8 1/4")

Plaster Spreaders
 Gipsspreizer
 Separadores para yeso
 Pinces pour plâtre
 Pinze per gesso

Engel Plaster Saw



Catalog #	Size
DR-171-15	15.5 cm (6")

Beeson Plaster Spreader



Catalog #	Size
DR-200-48	30 cm (12")

Hennig Plaster Spreader



Catalog #	Size
DR-220-28	28 cm (11")

Quattro (Mod. USA) Plaster Spreader



Catalog #	Size
DR-228-23	23 cm (9")

Wolff Plaster Breaker



Catalog #	Size
DR-251-18	18 cm (7")
DR-251-26	26.5 cm (10 1/2")

Plaster Shears
 Gipsscheren
 Tijeras para yeso
 Ciseaux pour plâtre
 Forbici per gesso

Surtext Oscipower™ Plaster Saw



Catalog #	Power Rating
DR-300-00	220 V
DR-300-01	110 V

**Wrench
 Pair**



Catalog #	Size
DR-320-01	Standard

Round Saw Blade

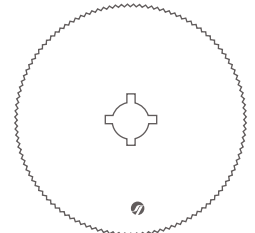

Catalog #	Diameter
DR-310-44	Ø 44 mm
DR-310-50	Ø 50 mm
DR-310-65	Ø 65 mm
DR-310-80	Ø 80 mm

Segment Saw Blade

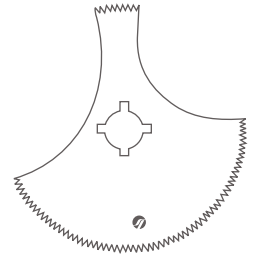

Catalog #	Diameter
DR-314-65	Ø 65 mm

Waisted Saw Blade

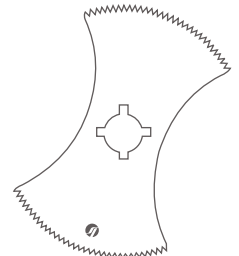

Catalog #	Diameter
DR-318-65	Ø 65 mm

Plaster Shears
Gipsscheren
Tijeras para yeso
Ciseaux pour plâtre
Forbici per gesso

Deep Saw Blade

Catalog #	Diameter
DR-320-70	Ø 70 mm

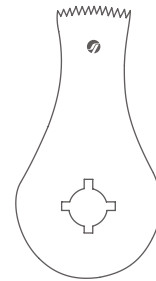

Deep Saw Blade for Aspiration

Catalog #	Diameter
DR-322-80	Ø 80 mm

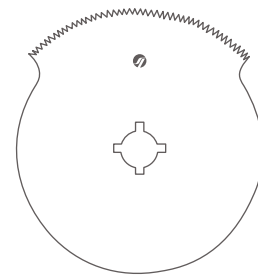

Vacuum Cleaner

Catalog #	Size
DR-400-00	Standard



HOSPITA®

ALWAYS THE BEST

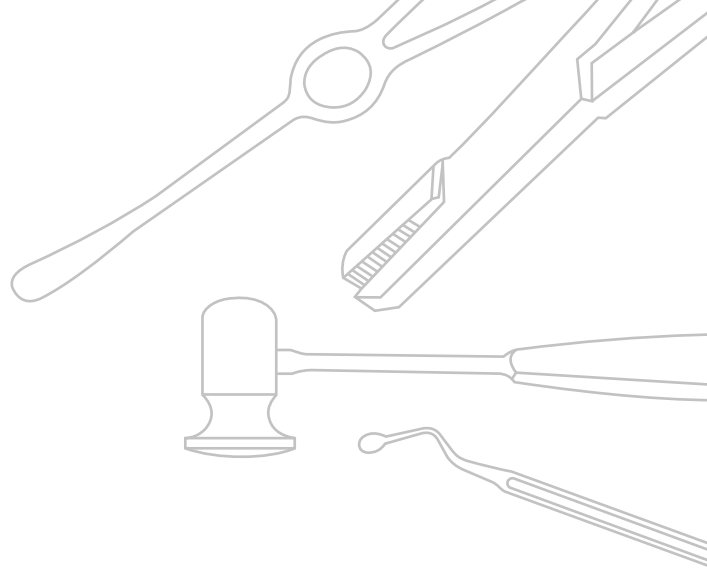

OR

BONE SURGERY

Hospita offers one of the most comprehensive range of orthopedic instruments in the global market place. The aim of these products is to facilitate easier and looking operations that minimize patient's post-operative discomfort. Whether you are one for specific instruments such as amputation saws, hand drills, mallets and instruments or complete orthopedic sets you will find that Hospita is the best orthopedic instrument solutions provider.

The choice of material with just the right Rockwell hardness value (HRC) in combination with the manufacturing method provides the osteotomes, chisels etc with their unique cutting properties. Special sharpening techniques allow the instruments to remain sharp for extended periods before they need to be re-sharpened. The handles are ergonomically designed for a firm and comfortable grip.

Our range of orthopedic instruments includes and is not limited to the following: amputation saws, battery operated drills, bone reamers, bone drills, twist drills, burrs, trephines, wire guides, extension bows, K-Wires, bone holding clamps, wire holding forceps, wire cutting forceps, autopsy instruments, bone chisels, bone osteotomes, bone gouges, bone rasps, bone tempers, bone mallets, bone curettes, periosteal elevators, bone levers, knee retractors, meniscus knives, tendon instruments, bone repositioning instruments, bone holding forceps, bone rongeurs, bone cutting forceps, aluminum hands and nail instruments.



Knochenchirurgie

Cirurgia ósea

Chirurgie osseuse

Chirurgia ossea

Amputation Saws
 Amputationssägen
 Sierras de amputación
 Scies à amputation
 Seghe per amputazione

Charriere Amputation Saw Complete
 With Saw Blade Ref: OR-010-92

Catalog #	Size
OR-010-35	35 cm (13 3/4")



Charriere Saw Blade

Catalog #	Blade Width
OR-010-91	12 mm
OR-010-92	15 mm
OR-010-93	18 mm



Bier Amputation Saw Complete
 With Saw Blade Ref: OR-012-92

Catalog #	Size
OR-012-40	40.5 cm (16")



Bier Saw Blade

Catalog #	Blade Width
OR-012-91	4 mm
OR-012-92	6 mm
OR-012-93	8 mm



Langenbeck Amputation Saw

Catalog #	Size
OR-014-24	24.5 cm (9 3/4")



Amputation Saws
Amputationssägen
Sierras de amputación
Scies à amputation
Seghe per amputazione

OR

BONE SURGERY

Charriere Amputation Saw Complete

With Saw Blade Ref: OR-016-90



Catalog #	Size
OR-016-27	26.5 cm (10 1/2")

Satterlee Amputation Saw Complete

With Saw Blade Ref: OR-018-90



Catalog #	Size
OR-018-29	29 cm (11 1/2")

Satterlee Saw Blade



Catalog #	Size
OR-018-90	Standard

Battery Operated Drill



Catalog #	Power Rating
OR-020-01	9.6 V

Adapter With Jacobs Chuck



Catalog #	Size
OR-020-02	Standard

Battery Drilling Unit
 Akku bohrapparat
 Unidad de perforación batería
 Unité de forage batterie
 Unità di foratura batteria

Adapter for K Wire

Catalog #	Size
OR-020-03	Standard



Adapter for DIN Chuck

Catalog #	Size
OR-020-04	Standard



Adapter for AO Chuck

Catalog #	Size
OR-020-05	Standard



Adapter for Harris Chuck

Catalog #	Size
OR-020-06	Standard



Adapter for Hudson Chuck

Catalog #	Size
OR-020-07	Standard



Battery Drilling Unit
 Akku bohrapparat
 Unidad de perforación batería
 Unité de forage batterie
 Unità di foratura batteria

Oscillating Sagittal Saw

Catalog #	Size
OR-020-08	Standard



Sternum Saw

Catalog #	Size
OR-020-09	Standard



Rechargeable Battery

Catalog #	Power Rating
OR-020-10	9.6 V
OR-020-11	12 V



Battery Charger For Single Battery

Catalog #	Power Rating
OR-020-12	220 V



Battery Charger For Two Batteries

Catalog #	Power Rating
OR-020-13	220 V



Reamer, Hand Drills
 Reibahlen
 Escariadores, Perforadores de mano
 Pointes-carrées, Perforateurs à main
 Punteruoli, Perforatori a mano

Battery Operated Sagittal Saw
 Fixed Model



Catalog #	Size
OR-022-01	Standard

Battery Operated Sternum Saw
 Fixed Model



Catalog #	Size
OR-022-02	Standard

Bone Reamer

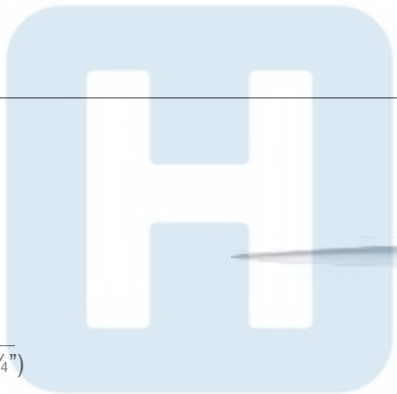

Catalog #	Size
OR-024-14	13.5 cm (5 1/4")

Perthes Bone Reamer



Catalog #	Size
OR-026-18	18 cm (7")

Perthes Bone Reamer



Catalog #	Size
OR-028-21	21.5 cm (8 1/2")

Reamer, Hand Drills
 Reibahlen
 Escariadores, Perforadores de mano
 Pointes-carrées, Perforateurs à main
 Punteruoli, Perforatori a mano

Bone Reamer



Catalog #	Size
OR-030-14	14 cm (5 1/2")

Drill Handle With Chuck
 T-Form, With Key Ref: OR-034-90



Catalog #	Size
OR-034-00	Standard

Key



Catalog #	Size
OR-034-90	Standard

Drill Handle With Chuck
 Longitudinally Bored, With Key Ref: OR-036-90



Catalog #	Size
OR-036-00	Standard

Key



Catalog #	Size
OR-036-90	Standard

Hand Drills
 Handbohrapparate
 Perforadores de mano
 Perforateurs à main
 Perforatori a mano

Stille-Sherman Drill Handle Complete
 With Twist Drill Ref: OR-044-01 to OR-044-03



Catalog #	Size
OR-040-00	25 cm (9 3/4")

Stille Drill Handle Complete
 With Twist Drill Ref: OR-044-01 to OR-044-03



Catalog #	Size
OR-042-00	20.5 cm (8")

Twist Drill

Catalog #	Diameter, Profile
OR-044-01	Ø 2.5 mm, Fig. 1
OR-044-02	Ø 3.0 mm, Fig. 2
OR-044-03	Ø 3.5 mm, Fig. 3
OR-044-04	Ø 4.0 mm, Fig. 4



Trephine
 Fig. 5



Catalog #	Diameter
OR-044-05	Ø 10.0 mm

Spherical Burr

Catalog #	Diameter, Profile
OR-044-06	Ø 5.0 mm, Fig. 6
OR-044-07	Ø 8.0 mm, Fig. 7
OR-044-08	Ø 12.0 mm, Fig. 8
OR-044-09	Ø 16.0 mm, Fig. 9



Hand Drills
Handbohrapparate
Perforadores de mano
Perforateurs à main
Perforatori a mano

OR

BONE SURGERY

Twist Drill

Catalog #	Diameter, Profile
OR-044-10	Ø 1.0 mm, Fig. 10
OR-044-11	Ø 1.5 mm, Fig. 11
OR-044-12	Ø 2.0 mm, Fig. 12



Hudson Hand Drill Complete

Complete With 4 Burrs Ref:- OR-050-01 up to OR-050-04

Catalog #	Size
OR-050-00	Standard

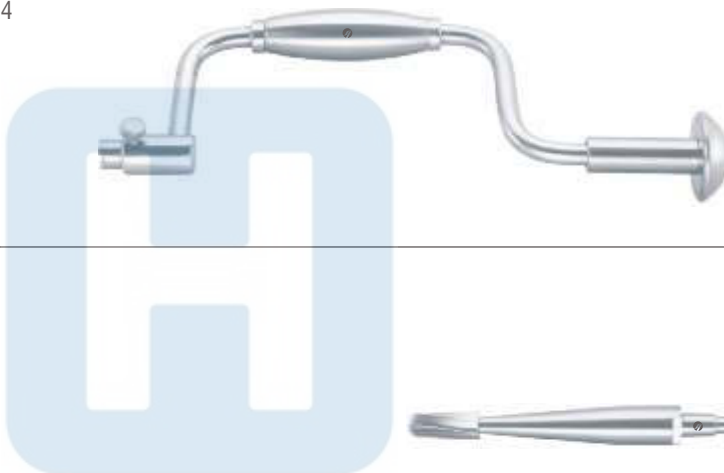

Conical Burr

Fig. 1

Catalog #	Diameter, Profile
OR-050-01	Ø 9.0 mm, Fig. 1
OR-050-02	Ø 14.0 mm, Fig. 2



Spherical Burr

Catalog #	Diameter, Profile
OR-050-03	Ø 16.0 mm, Fig. 3
OR-050-04	Ø 22.0 mm, Fig. 4



Cushing Flat Trepphine

Catalog #	Diameter, Profile
OR-050-05	Ø 14.0 mm, Fig. 5



Hand Drills
 Handbohrapparate
 Perforadores de mano
 Perforateurs à main
 Perforatori a mano

McKenzie Burr



Catalog #	Diameter, Profile
OR-050-07	Ø 13.0 mm, Fig. 7

Extension Piece



Catalog #	Size
OR-050-09	Standard

Moore Handle Drill

Complete With A Set of Twist Drill Ref: OR-053-03

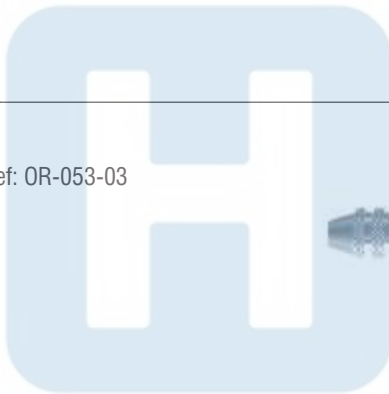

Catalog #	Size
OR-054-00	Standard

Twist Drill

Set of 3



Catalog #	Contents
OR-053-03	(2 Pcs (Ø 3.2 x 70 mm and 1 Pcs Ø 3.2 mm x 90 mm)

Martin Hand Drill Complete with Jacobs Chak

Complete With Jacobs With Ref: OR-058-91 and OR-058-92



Catalog #	Size
OR-058-00	Standard

Hand Drills, Twist Drill, Flat Trephines
 Handbohrapparate, Spiralbohrer, Flachbohrer, Kugelfräser
 Perforadores de mano, Broca espiral, Taladros planos
 Perforateurs à main, Mèche hélicoïdale, Trépan plats
 Perforatori a mano, Punte a spirale, Trapani piatti

Jacobs Chuck
 With Borchardt Shaft



Catalog #	Maximum Opening
OR-058-91	6.35 mm

Key



Catalog #	Size
OR-058-92	Standard

Borchardt Twist Drill
 5 mm Borchardt Shaft, Long Working End



Catalog #	Diameter
OR-060-20	Ø 2.0 mm
OR-060-25	Ø 2.5 mm
OR-060-30	Ø 3.0 mm
OR-060-32	Ø 3.2 mm
OR-060-35	Ø 3.5 mm
OR-060-40	Ø 4.0 mm
OR-060-50	Ø 5.0 mm
OR-060-60	Ø 6.0 mm
OR-060-70	Ø 7.0 mm

Twist Drill, Flat Trephines
 Spiralbohrer, Flachbohrer, Kugelfräser
 Broca espiral, Taladros planos
 Mèche hélicoïdale, Trépan plats
 Punte a spirale, Trapani piatti

Borchardt Twist Drill

5 mm Borchardt Shaft

Catalog #	Diameter
OR-062-10	Ø 1.0 mm
OR-062-12	Ø 1.2 mm
OR-062-15	Ø 1.5 mm
OR-062-18	Ø 1.8 mm
OR-062-20	Ø 2.0 mm
OR-062-22	Ø 2.2 mm
OR-062-25	Ø 2.5 mm
OR-062-28	Ø 2.8 mm
OR-062-30	Ø 3.0 mm
OR-062-32	Ø 3.2 mm
OR-062-35	Ø 3.5 mm
OR-062-40	Ø 4.0 mm
OR-062-50	Ø 5.0 mm



Borchardt Flat Trephine

5 mm Borchardt Shaft

Catalog #	Diameter
OR-064-18	Ø 1.8 mm
OR-064-20	Ø 2.0 mm
OR-064-22	Ø 2.2 mm
OR-064-25	Ø 2.5 mm
OR-064-30	Ø 3.0 mm
OR-064-35	Ø 3.5 mm
OR-064-40	Ø 4.0 mm
OR-064-50	Ø 5.0 mm



Spherical Burr

5 mm Borchardt Shaft

Catalog #	Diameter
OR-066-30	Ø 4.0 mm
OR-066-40	Ø 4.5 mm



Twist Drill, Flat Trephines
 Spiralbohrer, Flachbohrer, Kugelfräser
 Broca espiral, Taladros planos
 Mèche hélicoïdale, Trépans plats
 Punta a spirale, Trapani piatti

Conical Burr, Fine Spacing
 5 mm Borchardt Shaft



Catalog #	Diameter
OR-068-30	Ø 4.0 mm
OR-068-50	Ø 5.0 mm

Twist Drill
 Smooth Shaft



Catalog #	Diameter
OR-070-10	Ø 1.0 mm
OR-070-15	Ø 1.5 mm
OR-070-20	Ø 2.0 mm
OR-070-25	Ø 2.5 mm
OR-070-28	Ø 2.8 mm
OR-070-30	Ø 3.0 mm
OR-070-32	Ø 3.2 mm
OR-070-35	Ø 3.5 mm
OR-070-40	Ø 4.0 mm
OR-070-45	Ø 4.5 mm
OR-070-50	Ø 5.0 mm
OR-070-60	Ø 6.0 mm

Doyen Spherical Burr
 Long Borchardt Shaft



Catalog #	Diameter
OR-072-04	Ø 4.0 mm
OR-072-06	Ø 6.0 mm
OR-072-08	Ø 8.0 mm
OR-072-10	Ø 10.0 mm
OR-072-12	Ø 12.0 mm
OR-072-14	Ø 14.0 mm
OR-072-16	Ø 16.0 mm

Twist Drill, Flat Trephines
 Spiralbohrer, Flachbohrer, Kugelfräser
 Broca espiral, Taladros planos
 Mèche hélicoïdale, Trépans plats
 Punte a spirale, Trapani piatti

Doyen Spherical Burr

Long Borchardt Shaft

Catalog #	Diameter
OR-074-04	Ø 4.0 mm
OR-074-06	Ø 6.0 mm
OR-074-08	Ø 8.0 mm
OR-074-10	Ø 10.0 mm
OR-074-12	Ø 12.0 mm
OR-074-14	Ø 14.0 mm
OR-074-16	Ø 16.0 mm



Doyen Conical Burr

Catalog #	Diameter
OR-076-12	Ø 12.0 mm



Conical Burr, Fine Spacing

Catalog #	Diameter
OR-078-08	Ø 8.0 mm
OR-078-10	Ø 10.0 mm



Doyen Cylindrical Burr, Coarse Spacing

Catalog #	Diameter
OR-080-12	Ø 12.0 mm
OR-080-15	Ø 15.0 mm



Twist Drill, Flat Trepines
Spiralbohrer, Flachbohrer, Kugelfräser
Broca espiral, Taladros planos
Mèche hélicoïdale, Trépans plats
Punte a spirale, Trapani piatti

Albee Oval, Coarse Spacing

Catalog #	Diameter
OR-082-08	Ø 8.0 mm
OR-082-10	Ø 10.0 mm
OR-082-12	Ø 12.0 mm



Albee Pointed Cutter

Catalog #	Diameter
OR-084-07	Ø 7.0 mm

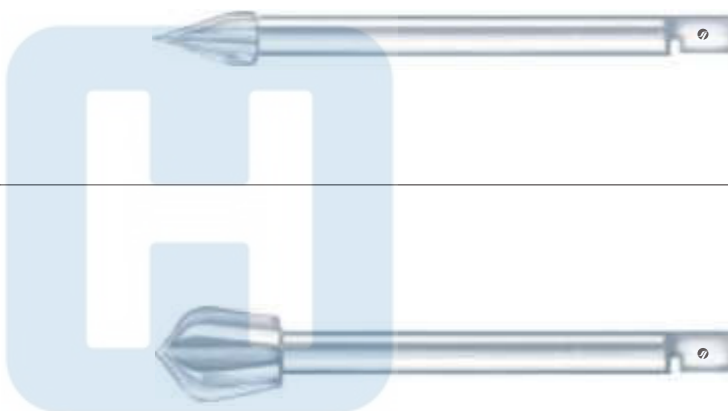

Borchardt Oval Burr, Coarse Spacing

Catalog #	Diameter
OR-086-13	Ø 13.0 mm



Flat Burr

Short Borchardt Shaft

Catalog #	Diameter
OR-088-25	Ø 25.0 mm



Toti Trepine

Short Borchardt Shaft

Catalog #	Diameter
OR-090-08	Ø 8.0 mm



Hand Drills, Wire Guides, Wire Tightener
 Handbohrapparate, Drahtumführungsadeln, Drahtspanner
 Perforadores de mano, Agujas pasa-hilo, Tensor cierra-hilo
 Perforateurs à main, Aiguilles passe-fils, Tendeur serre-fil
 Perforatori a mano, Aghi passafili, Strumento tendifili

Bunnell Hand Drill

Longitudinally Bored With 3 Jaw Chuck and Key, Light Metal Housing
 Opening up to 4mm Ø



Catalog #	Size
OR-094-00	Standard

Ralk Hand Drill

Longitudinally Bored With 3 Jaw Chuck and Key, Light Metal Housing,
 Opening up to 4mm Ø



Catalog #	Size
OR-096-00	Standard

Key



Catalog #	Size
OR-098-00	Standard

Screw Driver



Catalog #	Size, Tip Size
OR-100-15	25 cm (10"), 1.5 mm
OR-100-25	25 cm (10"), 2.5 mm
OR-100-35	25 cm (10"), 3.5 mm
OR-100-90	25 cm (10"), Standard
OR-100-91	25 cm (10"), Standard
OR-100-92	25 cm (10"), Standard

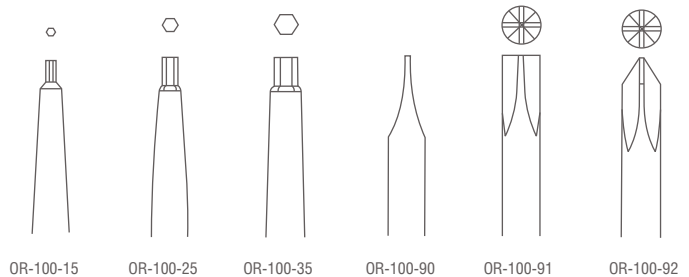

Demel Wire Guide

Catalog #	Size, Profile
OR-101-01	31 cm (12 1/4"), Fig. 1
OR-101-02	29 cm (11 1/2"), Fig. 2
OR-101-03	28 cm (11"), Fig. 3



Wire Tightener, Extension Bows
 Drahtspanner, Extensionsbügel
 Tensor cierra-hilo, Estribos para extensión
 Tendeur serre-fil, Etriers à extension
 Strumento tendifili, Archi per estensione

Loute Wire Tightener



Catalog #	Size
OR-104-21	21 cm (8 1/4")

Demel Wire Tightener and Twister



Catalog #	Size
OR-106-27	27 cm (10 3/4")

Steinmann Extension Pins With Trocar Point



Catalog #	Size
OR-108-14	14 cm (5 1/2")
OR-108-16	16 cm (6 1/4")
OR-108-18	18 cm (7")
OR-108-20	20 cm (8")

Bohler Extension Bows



Catalog #	Inner Width, Profile
OR-110-15	210 x 150 mm For Femur and Knee
OR-110-16	160 x 90 mm For Arm
OR-110-21	210 x 110 mm For Femur and Knee

Extension Bows
 Extensionsbügel
 Estribos para extensión
 Etriers à extension
 Archi per estensione

Kirschner Extension Bows
 With 3 Traction Hooks

Catalog #	Size, Inner Width, Profile
OR-114-01	90 x 70 mm, For Children
OR-114-02	105 x 105 mm, For Wrist and Ankle
OR-114-03	120 x 120 mm, For Elbow
OR-114-04	155 x 155 mm, For Knee
OR-114-05	200 x 155 mm, For Femur



Kirschner Extension Bows
 With 3 Traction Hooks

Catalog #	Size, Profile
OR-116-01	18.5 cm (7 1/4"), Small Pattern
OR-116-02	26.5 cm (10 1/2"), Large Pattern



Wire Strainer
 For Ref: OR-581-01 up to OR-581-05

Catalog #	Size
OR-118-18	18.5 cm (7 1/4")



Wrench

Catalog #	Size
OR-120-20	20 cm (8")



Extension Bows

Catalog #	Inner Width
OR-122-18	180 x 100mm (7" x 4")
OR-122-27	270 x 160mm (10 1/2" x 6 1/4")



Kirschner Wire Drill
Trocar Pointed, Flat End

Catalog #	Size, Diameter
OR-130-06	6 cm (2 1/4"), Ø 0.6 mm
OR-130-08?	6 cm (2 1/4"), Ø 0.8 mm
OR-130-10	6 cm (2 1/4"), Ø 1.0 mm
OR-130-12	6 cm (2 1/4"), Ø 1.2 mm
OR-130-14	6 cm (2 1/4"), Ø 1.4 mm
OR-130-15	6 cm (2 1/4"), Ø 1.5 mm
OR-130-16	6 cm (2 1/4"), Ø 1.6 mm
OR-130-18	6 cm (2 1/4"), Ø 1.8 mm
OR-130-20	6 cm (2 1/4"), Ø 2.0 mm
OR-130-22	6 cm (2 1/4"), Ø 2.2 mm



Kirschner Wire Drill
Trocar Pointed, Round End

Catalog #	Size, Diameter
OR-132-10	6 cm (2 1/4"), Ø 1.0 mm
OR-132-12	6 cm (2 1/4"), Ø 1.2 mm
OR-132-14	6 cm (2 1/4"), Ø 1.4 mm
OR-132-15	6 cm (2 1/4"), Ø 1.5 mm
OR-132-16	6 cm (2 1/4"), Ø 1.6 mm
OR-132-18	6 cm (2 1/4"), Ø 1.8 mm
OR-132-20	6 cm (2 1/4"), Ø 2.0 mm
OR-132-22	6 cm (2 1/4"), Ø 2.2 mm

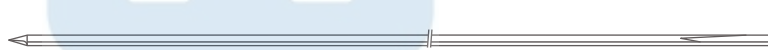

Kirschner Wire Drill
Trocar Pointed, Round End

Catalog #	Size, Diameter
OR-134-10	10 cm (4"), Ø 1.0 mm
OR-134-12	10 cm (4"), Ø 1.2 mm
OR-134-14	10 cm (4"), Ø 1.4 mm
OR-134-16	10 cm (4"), Ø 1.5 mm



Wire Drills
Spickdråhte
Brocas filiformes
Broches filiformes
Perforatori filiformi

Kirschner Wire Drill
Trocar Pointed, Flat End

Catalog #	Size, Diameter
OR-136-10	12 cm (4 3/4"), Ø 1.0 mm
OR-136-12	12 cm (4 3/4"), Ø 1.2 mm
OR-136-14	12 cm (4 3/4"), Ø 1.4 mm
OR-136-15	12 cm (4 3/4"), Ø 1.5 mm
OR-136-16	12 cm (4 3/4"), Ø 1.6 mm
OR-136-18	12 cm (4 3/4"), Ø 1.8 mm
OR-136-20	12 cm (4 3/4"), Ø 2.0 mm
OR-136-22	12 cm (4 3/4"), Ø 2.2 mm



Kirschner Wire Drill
Trocar Pointed, Round End

Catalog #	Size, Diameter
OR-138-10	12 cm (4 3/4"), Ø 1.0 mm
OR-138-12	12 cm (4 3/4"), Ø 1.2 mm
OR-138-14	12 cm (4 3/4"), Ø 1.4 mm
OR-138-15	12 cm (4 3/4"), Ø 1.5 mm
OR-138-16	12 cm (4 3/4"), Ø 1.6 mm
OR-138-18	12 cm (4 3/4"), Ø 1.8 mm
OR-138-20	12 cm (4 3/4"), Ø 2.0 mm
OR-138-22	12 cm (4 3/4"), Ø 2.2 mm



Kirschner Wire Drill
Trocar Pointed, Flat End

Catalog #	Size, Diameter
OR-140-10	14 cm (5 1/2"), Ø 1.0 mm
OR-140-12	14 cm (5 1/2"), Ø 1.2 mm
OR-140-14	14 cm (5 1/2"), Ø 1.4 mm
OR-140-15	14 cm (5 1/2"), Ø 1.5 mm
OR-140-16	14 cm (5 1/2"), Ø 1.6 mm
OR-140-18	14 cm (5 1/2"), Ø 1.8 mm
OR-140-20	14 cm (5 1/2"), Ø 2.0 mm
OR-140-22	14 cm (5 1/2"), Ø 2.2 mm



Kirschner Wire Drill

Trocar Pointed, Round End

Catalog #	Size, Diameter
OR-142-10	14 cm (5 1/2"), Ø 1.0 mm
OR-142-12	14 cm (5 1/2"), Ø 1.2 mm
OR-142-14	14 cm (5 1/2"), Ø 1.4 mm
OR-142-15	14 cm (5 1/2"), Ø 1.5 mm
OR-142-16	14 cm (5 1/2"), Ø 1.6 mm
OR-142-18	14 cm (5 1/2"), Ø 1.8 mm
OR-142-20	14 cm (5 1/2"), Ø 2.0 mm
OR-142-22	14 cm (5 1/2"), Ø 2.2 mm



Kirschner Wire Drill

Trocar Pointed, Flat End

Catalog #	Size, Diameter
OR-144-10	16 cm (6 1/4"), Ø 1.0 mm
OR-144-12	16 cm (6 1/4"), Ø 1.2 mm
OR-144-14	16 cm (6 1/4"), Ø 1.4 mm
OR-144-15	16 cm (6 1/4"), Ø 1.5 mm
OR-144-16	16 cm (6 1/4"), Ø 1.6 mm
OR-144-18	16 cm (6 1/4"), Ø 1.8 mm
OR-144-20	16 cm (6 1/4"), Ø 2.0 mm
OR-144-22	16 cm (6 1/4"), Ø 2.2 mm
OR-144-25	16 cm (6 1/4"), Ø 2.5 mm

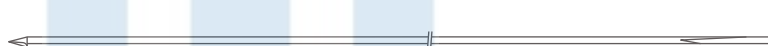

Kirschner Wire Drill

Trocar Pointed, Round End

Catalog #	Size, Diameter
OR-146-10	16 cm (6 1/4"), Ø 1.0 mm
OR-146-12	16 cm (6 1/4"), Ø 1.2 mm
OR-146-14	16 cm (6 1/4"), Ø 1.4 mm
OR-146-15	16 cm (6 1/4"), Ø 1.5 mm
OR-146-16	16 cm (6 1/4"), Ø 1.6 mm
OR-146-18	16 cm (6 1/4"), Ø 1.8 mm
OR-146-20	16 cm (6 1/4"), Ø 2.0 mm
OR-146-22	16 cm (6 1/4"), Ø 2.2 mm
OR-146-25	16 cm (6 1/4"), Ø 2.5 mm



Wire Drills
Spickdrähte
Brocas filiformes
Broches filiformes
Perforatori filiformi

Kirschner Wire Drill
Trocar Pointed, Flat End

Catalog #	Size, Diameter
OR-148-10	31 cm (12 1/4"), Ø 1.0 mm
OR-148-12	31 cm (12 1/4"), Ø 1.2 mm
OR-148-14	31 cm (12 1/4"), Ø 1.4 mm
OR-148-15	31 cm (12 1/4"), Ø 1.5 mm
OR-148-16	31 cm (12 1/4"), Ø 1.6 mm
OR-148-18	31 cm (12 1/4"), Ø 1.8 mm
OR-148-20	31 cm (12 1/4"), Ø 2.0 mm
OR-148-22	31 cm (12 1/4"), Ø 2.2 mm
OR-148-25	31 cm (12 1/4"), Ø 2.5 mm



Kirschner Wire Drill
Trocar Pointed, Round End

Catalog #	Size, Diameter
OR-150-10	31 cm (12 1/4"), Ø 1.0 mm
OR-150-12	31 cm (12 1/4"), Ø 1.2 mm
OR-150-14	31 cm (12 1/4"), Ø 1.4 mm
OR-150-15	31 cm (12 1/4"), Ø 1.5 mm
OR-150-16	31 cm (12 1/4"), Ø 1.6 mm
OR-150-18	31 cm (12 1/4"), Ø 1.8 mm
OR-150-20	31 cm (12 1/4"), Ø 2.0 mm
OR-150-22	31 cm (12 1/4"), Ø 2.2 mm
OR-150-25	31 cm (12 1/4"), Ø 2.5 mm



Kirschner Wire Drill
Trocar Pointed, Round End

Catalog #	Size, Diameter
OR-152-10	10 cm (4"), Ø 1.0 mm
OR-152-12	10 cm (4"), Ø 1.2 mm
OR-152-15	10 cm (4"), Ø 1.5 mm
OR-152-16	10 cm (4"), Ø 1.6 mm
OR-152-18	10 cm (4"), Ø 1.8 mm
OR-152-20	10 cm (4"), Ø 2.0 mm
OR-152-22	10 cm (4"), Ø 2.2 mm
OR-152-25	10 cm (4"), Ø 2.5 mm



Wire Twisting Forceps
 Drahtwirbelzangen
 Pinzas para torcer alambre
 Pinces à torsader le fil
 Pinze per ritorcere fili

Gerster-Lowman Bone Holding Clamp

Catalog #	Size
OR-160-18	18 cm (7")
OR-160-20	20 cm (8")
OR-160-22	22 cm (8 ¾")



Gerster Traction Bar

Catalog #	Size
OR-162-15	Standard



UltraGrip™ TC Wire Twisting Forcep



Catalog #	Size
OR-170-15	15.5 cm (6")
OR-170-18	18 cm (7")

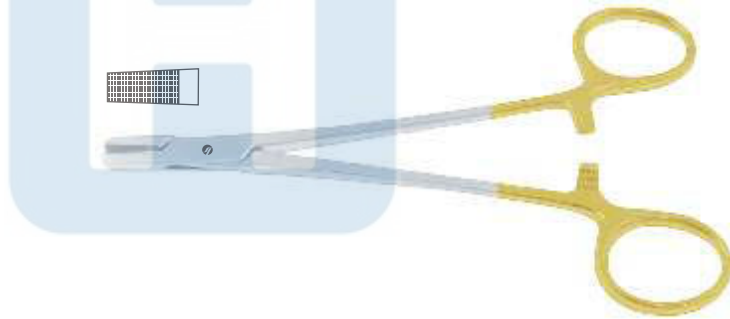

UltraGrip™ TC Wire Twisting Forcep



Catalog #	Size
OR-172-15	15.5 cm (6")
OR-172-18	18 cm (7")



UltraGrip™ TC Wire Twisting Forcep



Catalog #	Size
OR-174-15	15.5 cm (6")
OR-174-20	20 cm (8")

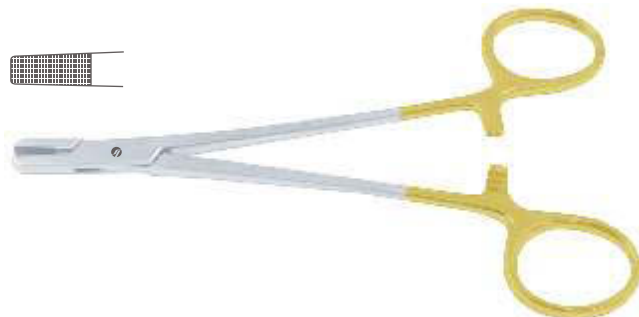

Wire Twisting Forceps
 Drahtwirbelzangen
 Pinzas para torcer alambre
 Pinces à torsader le fil
 Pinze per ritorcere fili

UltraGrip™ TC Baumgartner Wire Twisting Forcep

ULTRAGripX™

Catalog #	Size
OR-176-20	20 cm (8")



UltraGrip™ TC Wire Twisting Forcep Curved

ULTRAGripX™

Catalog #	Size
OR-177-15	14.5 cm (5 3/4")



UltraGrip™ TC Corwin Wire Twisting Forcep

ULTRAGripX™

Catalog #	Size
OR-180-16	16 cm (6 1/4")



UltraGrip™ TC Combi Wire Twisting Forcep

ULTRAGripX™

Catalog #	Size
OR-182-18	18.5 cm (7 1/4")

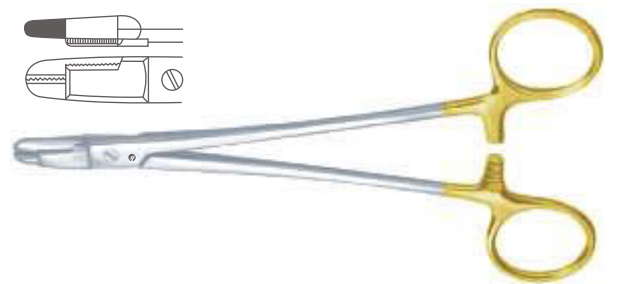

UltraGrip™ TC Berry Wire Twisting Forcep Heavy Pattern, With Tungsten Carbide Inserts

ULTRAGripX™

Catalog #	Size
OR-184-19	19 cm (7 1/2")

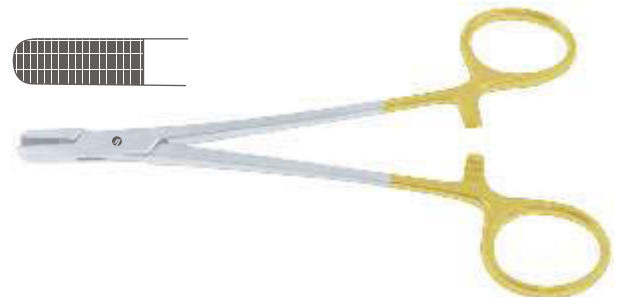

Wire Twisting Forceps, Flat Nose Pliers
 Drahtwirbelzangen, Flachzangen
 Pinzas para torcer alambre, Alicates de pico plano
 Pinces à torsader le fil, Pinces plates
 Pinze per ritorcere fili, Tenaglie piatte

UltraGrip™ Combi-Flat Nose Plier
 Parallel Grip, Compound Action

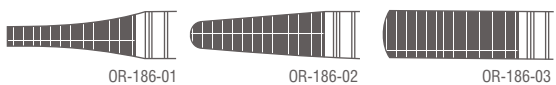

Catalog #	Size
OR-186-01	18 cm (7")
OR-186-02	18 cm (7")
OR-186-03	18 cm (7")

Flat Nose Plier

Catalog #	Size
OR-190-14	13.5 cm (5 1/4")

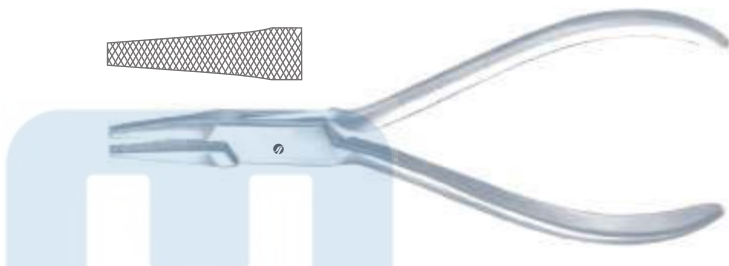

Flat Nose Plier

Catalog #	Size
OR-192-14	14 cm (5 1/4")

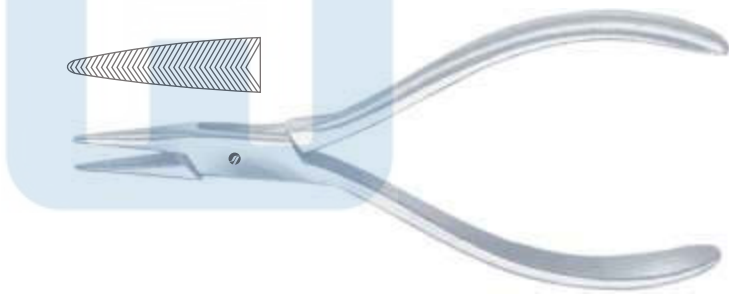

Flat Nose Plier

Catalog #	Size
OR-194-14	14 cm (5 1/4")



Flat Nose Plier

Catalog #	Size
OR-196-17	17.5 cm (7")



Flat Nose Pliers, Vise Grip, Combi-Flat Nose Plier
 Flachzangen, Tonnenzange, Kombinationszange, Flachzangen
 Alicates de pico plano, Alicates de pico plano, Combi-Alicate de alambre
 Pinces plates, Pinces plates, Combi-Pince pour fils
 Tenaglie piatte, Tenaglie piatte, Combi-Pinza per fili

Flat Nose Plier
 With Crosswise Groove

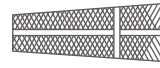

Catalog #	Size
OR-198-17	17 cm (6 3/4")

Flat Nose Plier
 Pointed

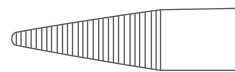

Catalog #	Size
OR-200-19	19.5 cm (7 3/4")

Flat Nose Plier
 With Longitudinal Groove

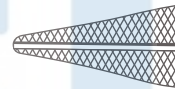

Catalog #	Size
OR-202-16	16 cm (6 1/4")

Combi-Flat Nose Plier
 For Bending and Cutting

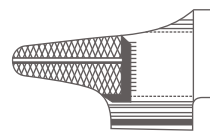

Catalog #	Size
OR-204-15	15 cm (6")

Flat Nose Plier
 Parallel Grip

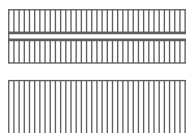

Catalog #	Size
OR-210-17	18.5 cm (7 1/4")

Flat Nose Pliers, Wire Cutting Pliers
 Flachzangen, Tonnenzange, Drahtkneifzangen
 Alicates de pico plano, Alicates para cortar alambre
 Pinces plates, Pinces plates, Pinces à couper le fil
 Tenaglie piatte, Tenaglie piatte, Tenaglie tagliafilì

Vise Grip Plier

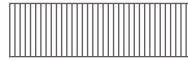

Catalog #	Size
OR-212-18	20.5 cm (8")

Combi-Flat Nose Plier

Parallel Grip, Compound Action



OR-214-01

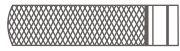

OR-214-02



OR-214-03



Catalog #	Size
OR-214-01	18 cm (7")
OR-214-02	18 cm (7")
OR-214-03	18 cm (7")

Flat Nose Plier



Catalog #	Size
OR-214-04	18 cm (7")

Wire Cutting Plier

For Soft Wires Up to 2.4 mm Ø, For Hard Wires Up to 1.8 mm Ø



Catalog #	Size
OR-220-18	18.5 cm (7 1/4")

Wire Cutting Plier

For Soft Wires Up to 2.2 mm Ø, For Hard Wires Up to 2.0 mm Ø



Catalog #	Size
OR-222-16	16 cm (6 1/4")

Wire Cutting Pliers
 Drahtkneifzangen
 Alicates para cortar alambre
 Pinces à couper le fil
 Tenaglie tagliafilì

UltraCut™ TC Wire Cutting Plier
 For Soft Wires Up to 1.5 mm Ø, For Hard Wires Up to 1.0 mm Ø

ULTRACut™

Catalog #	Size
OR-230-13	13 cm (5 ¼")



UltraCut™ TC Wire Cutting Plier
 For Soft Wires Up to 3.5 mm Ø, For Hard Wires Up to 2.5 mm Ø

ULTRACut™

Catalog #	Size
OR-232-16	16.5 cm (6 ½")

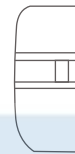

UltraCut™ TC Wire Cutting Plier
 For Soft Wires Up to 2.0 mm Ø, For Hard Wires Up to 1.7 mm Ø

ULTRACut™

Catalog #	Size
OR-234-18	17.5 cm (7")



UltraCut™ TC Wire Cutting Plier
 For Soft Wires Up to 2.8 mm Ø, For Hard Wires Up to 2.2 mm Ø

ULTRACut™

Catalog #	Size
OR-234-22	22.5 cm (8 ¾")



UltraCut™ TC Wire Cutting Plier
 For Soft Wires Up to 3.0 mm Ø, For Hard Wires Up to 2.2 mm Ø

ULTRACut™

Catalog #	Size
OR-236-23	23 cm (9")

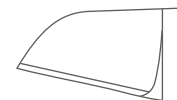

Wire Cutting Pliers, Autopsy Instruments
 Drahtkneifzangen, Autopsie Instrumente
 Alicates para cortar alambre, Instrumentos para la autopsia
 Pinces à couper le fil, Instruments pour la autopsie
 Tenaglie tagliafili, Strumenti per autopsia

UltraCut™ TC Wire Cutting Plier

For Soft Wires Up to 2.0 mm Ø, For Hard Wires Up to 1.2 mm Ø

ULTRACut™

Catalog #	Size
OR-238-15	15 cm (6")



UltraCut™ TC Wire Cutting Plier

For Soft Wires Up to 3.0 mm Ø, For Hard Wires Up to 2.0 mm Ø

ULTRACut™

Catalog #	Size
OR-238-22	22 cm (8 3/4")

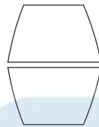

UltraCut™ TC Wire Cutting Plier / Plate Cutter

For Wires Up to 6 mm Ø

ULTRACut™

Catalog #	Size
OR-240-47	47 cm (18 1/2")

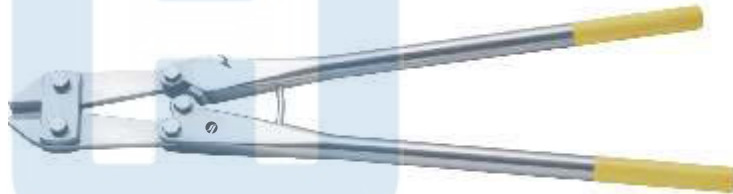

Virchow Skull Breaker

Catalog #	Blade Width
OR-250-00	15 mm



Skull Breaker

Catalog #	Size
OR-252-14	14 cm (5 1/2")



Autopsy Instruments
 Autopsie Instrumente
 Instrumentos para la autopsia
 Instruments pour la autopsie
 Strumenti per autopsia

Rachietome



Catalog #	Size
OR-254-22	22 cm (8 3/4")

Post Mortem Chisel



Catalog #	Size, Blade Width
OR-256-20	13 cm (5 1/4"), 20 mm
OR-256-23	13 cm (5 1/4"), 23 mm

Brunetti Post Mortem Chisel

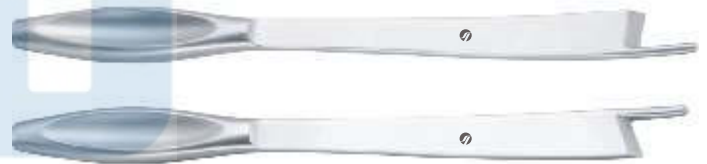

Catalog #	Size, Profile
OR-258-01	28.5 cm (11 1/4"), Left
OR-258-02	28.5 cm (11 1/4"), Right

**Post Mortem Hammer
 With Hook Handle**



Catalog #	Size
OR-260-24	24 cm (9 1/2")

Bone Chisel



Catalog #	Size, Blade Width
OR-280-04	17 cm (6 3/4"), 4 mm

Autopsy Instruments, Bone Chisels, Gouges
 Autopsie Instrumente, Knochenmeißel, Hohlmeißel
 Instrumentos para la autopsia, Cinceles, Gubias
 Instruments pour la autopsie, Ciseaux-burins, Gouges
 Strumenti per autopsia, Scalpelli, Sgorbie

Bone Osteotome



Catalog #	Size, Blade Width
OR-282-04	17 cm (6 3/4"), 4 mm

Gardner Bone Chisel Triangular Shape

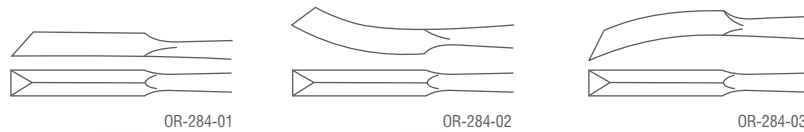

Catalog #	Size, Blade Width, Profile
OR-284-01	17 cm (6 3/4"), 4 mm
OR-284-02	17 cm (6 3/4"), 4 mm, Curved Right
OR-284-03	17 cm (6 3/4"), 4 mm, Curved Left

Snyder-O.S.U Bone Gouge

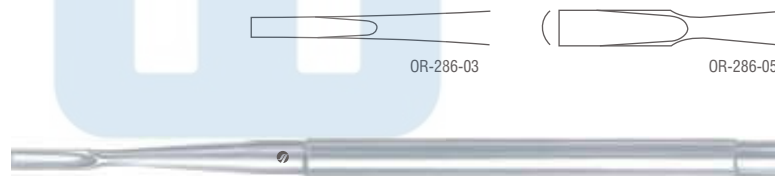

Catalog #	Size, Blade Width
OR-286-03	16.5 cm (6 1/2"), 3 mm
OR-286-05	16.5 cm (6 1/2"), 5 mm

Bone Osteotome



Catalog #	Size, Blade Width
OR-300-08	13.5 cm (5 1/4"), 8 mm
OR-300-10	13.5 cm (5 1/4"), 10 mm
OR-300-12	13.5 cm (5 1/4"), 12 mm
OR-300-14	13.5 cm (5 1/4"), 14 mm
OR-300-16	13.5 cm (5 1/4"), 16 mm

Bone Chisels, Gouges
 Knochenmeißel, Hohlmeißel
 Cinceles, Gubias
 Ciseaux-burins, Gouges
 Scalpelli, Sgorbie

Bone Chisel

Catalog #	Size, Blade Width
OR-301-08	13.5 cm (5 1/4"), 8 mm
OR-301-10	13.5 cm (5 1/4"), 10 mm
OR-301-12	13.5 cm (5 1/4"), 12 mm
OR-301-14	13.5 cm (5 1/4"), 14 mm
OR-301-16	13.5 cm (5 1/4"), 16 mm

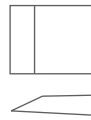

Bone Gouge

Catalog #	Size, Blade Width
OR-302-08	13.5 cm (5 1/4"), 8 mm
OR-302-10	13.5 cm (5 1/4"), 10 mm
OR-302-12	13.5 cm (5 1/4"), 12 mm
OR-302-14	13.5 cm (5 1/4"), 14 mm
OR-302-16	13.5 cm (5 1/4"), 16 mm



Partsch Bone Chisel

Catalog #	Size, Blade Width
OR-305-02	13.5 cm (5 1/4"), 2 mm
OR-305-03	13.5 cm (5 1/4"), 3 mm
OR-305-04	13.5 cm (5 1/4"), 4 mm
OR-305-05	13.5 cm (5 1/4"), 5 mm
OR-305-06	13.5 cm (5 1/4"), 6 mm
OR-305-07	13.5 cm (5 1/4"), 7 mm
OR-305-08	13.5 cm (5 1/4"), 8 mm

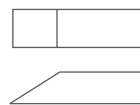

Bone Chisels, Gouges
Knochenmeißel, Hohlmeißel
Cinceles, Gubias
Ciseaux-burins, Gouges
Scalpelli, Sgorbie

Partsch Bone Chisel

Catalog #	Size, Blade Width
OR-306-02	17 cm (6 3/4"), 2 mm
OR-306-03	17 cm (6 3/4"), 3 mm
OR-306-04	17 cm (6 3/4"), 4 mm
OR-306-05	17 cm (6 3/4"), 5 mm
OR-306-06	17 cm (6 3/4"), 6 mm
OR-306-07	17 cm (6 3/4"), 7 mm
OR-306-08	17 cm (6 3/4"), 8 mm



Partsch Bone Gouge

Catalog #	Size, Blade Width
OR-309-02	13.5 cm (5 1/4"), 2 mm
OR-309-03	13.5 cm (5 1/4"), 3 mm
OR-309-04	13.5 cm (5 1/4"), 4 mm
OR-309-05	13.5 cm (5 1/4"), 5 mm
OR-309-06	13.5 cm (5 1/4"), 6 mm
OR-309-07	13.5 cm (5 1/4"), 7 mm
OR-309-08	13.5 cm (5 1/4"), 8 mm



Partsch Bone Gouge

Catalog #	Size, Blade Width
OR-310-02	17 cm (6 3/4"), 2 mm
OR-310-03	17 cm (6 3/4"), 3 mm
OR-310-04	17 cm (6 3/4"), 4 mm
OR-310-05	17 cm (6 3/4"), 5 mm
OR-310-06	17 cm (6 3/4"), 6 mm
OR-310-07	17 cm (6 3/4"), 7 mm
OR-310-08	17 cm (6 3/4"), 8 mm



Bone Chisels, Gouges, Osteotomes
 Knochenmeißel, Hohlmeißel, Osteotome
 Cinceles, Gubias, Osteótomos
 Ciseaux-burins, Gouges, Ostéotomes
 Scalpelli, Sgorbie, Osteotomi

Alexander Bone Chisel

Catalog #	Size, Blade Width
OR-314-04	17.5 cm (7"), 4 mm
OR-314-06	17.5 cm (7"), 6 mm
OR-314-08	17.5 cm (7"), 8 mm
OR-314-10	17.5 cm (7"), 10 mm
OR-314-12	17.5 cm (7"), 12 mm
OR-314-14	17.5 cm (7"), 14 mm



Alexander Bone Gouge

Catalog #	Size, Blade Width
OR-315-04	17.5 cm (7"), 4 mm
OR-315-06	17.5 cm (7"), 6 mm
OR-315-08	17.5 cm (7"), 8 mm
OR-315-10	17.5 cm (7"), 10 mm
OR-315-12	17.5 cm (7"), 12 mm
OR-315-14	17.5 cm (7"), 14 mm



Mini-Lambotte Bone Osteotome

Catalog #	Size, Blade Width
OR-320-02	12.5 cm (5"), 2 mm
OR-320-03	12.5 cm (5"), 3 mm
OR-320-04	12.5 cm (5"), 4 mm
OR-320-06	12.5 cm (5"), 6 mm
OR-320-08	12.5 cm (5"), 8 mm
OR-320-10	12.5 cm (5"), 10 mm
OR-320-12	12.5 cm (5"), 12 mm
OR-320-15	12.5 cm (5"), 15 mm



Mini-Lambotte Bone Osteotome

Catalog #	Size, Blade Width
OR-322-03	17 cm (6 ¾"), 3 mm
OR-322-04	17 cm (6 ¾"), 4 mm
OR-322-06	17 cm (6 ¾"), 6 mm
OR-322-08	17 cm (6 ¾"), 8 mm
OR-322-10	17 cm (6 ¾"), 10 mm
OR-322-12	17 cm (6 ¾"), 12 mm
OR-322-15	17 cm (6 ¾"), 15 mm



Lambotte Bone Osteotome

Catalog #	Size, Blade Width
OR-324-15	24 cm (9 ½"), 15 mm
OR-324-20	24 cm (9 ½"), 20 mm
OR-324-25	24 cm (9 ½"), 25 mm
OR-324-30	24 cm (9 ½"), 30 mm
OR-324-38	24 cm (9 ½"), 38 mm
OR-320-44	24 cm (9 ½"), 44 mm
OR-320-50	24 cm (9 ½"), 50 mm



Lambotte Bone Osteotome Curved

Catalog #	Size, Blade Width
OR-325-15	24 cm (9 ½"), 15 mm
OR-325-20	24 cm (9 ½"), 20 mm
OR-325-25	24 cm (9 ½"), 25 mm
OR-325-30	24 cm (9 ½"), 30 mm
OR-325-38	24 cm (9 ½"), 38 mm
OR-325-44	24 cm (9 ½"), 44 mm
OR-325-50	24 cm (9 ½"), 50 mm

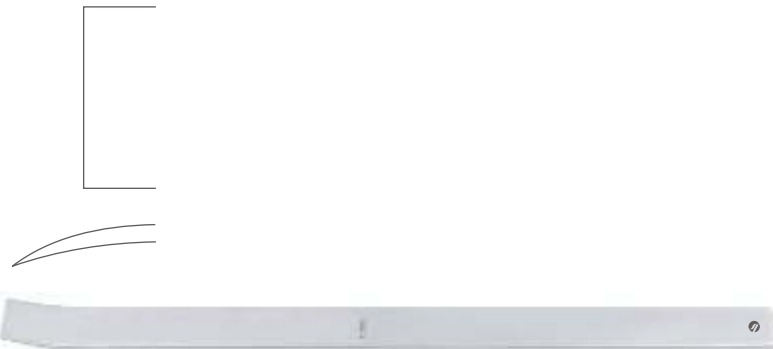

Chisels, Osteotomes, Gouges
 Flachmeißel, Osteotome, Hohlmeißel
 Cinceles, Osteótomos, Gubias
 Ciseaux-burins, Ostéotomes, Gouges
 Scalpelli, Osteotomi, Sgorbie

Stille Bone Chisel

Catalog #	Size, Blade Width
OR-328-10	20 cm (8"), 10 mm
OR-328-15	20 cm (8"), 15 mm
OR-328-20	20 cm (8"), 20 mm
OR-328-25	20 cm (8"), 25 mm



Stille Bone Osteotome

Catalog #	Size, Blade Width
OR-329-10	20 cm (8"), 10 mm
OR-329-15	20 cm (8"), 15 mm
OR-329-20	20 cm (8"), 20 mm
OR-329-25	20 cm (8"), 25 mm



Stille Bone Gouge

Catalog #	Size, Blade Width
OR-330-10	20 cm (8"), 10 mm
OR-330-15	20 cm (8"), 15 mm
OR-330-20	20 cm (8"), 20 mm
OR-330-25	20 cm (8"), 25 mm



Smith-Peterson Bone Osteotome

Catalog #	Size, Blade Width
OR-332-06	20.5 cm (8"), 6 mm
OR-332-09	20.5 cm (8"), 9 mm
OR-332-13	20.5 cm (8"), 13 mm
OR-332-16	20.5 cm (8"), 16 mm
OR-332-19	20.5 cm (8"), 19 mm
OR-332-25	20.5 cm (8"), 25 mm
OR-332-32	20.5 cm (8"), 32 mm

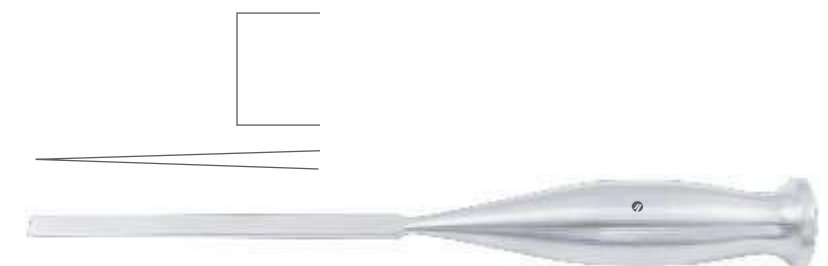

Osteotomes, Gouges
 Osteotome, Hohlmeißel
 Osteótomos, Gubias
 Ostéotomes, Gouges
 Osteotomi, Sgorbie

Smith-Peterson Bone Osteotome
 Curved

Catalog #	Size, Blade Width
OR-333-06	20.5 cm (8"), 6 mm
OR-333-09	20.5 cm (8"), 9 mm
OR-333-13	20.5 cm (8"), 13 mm
OR-333-16	20.5 cm (8"), 16 mm
OR-333-19	20.5 cm (8"), 19 mm
OR-333-25	20.5 cm (8"), 25 mm
OR-333-32	20.5 cm (8"), 32 mm



Smith-Peterson Bone Gouge

Catalog #	Size, Blade Width
OR-334-09	20.5 cm (8"), 9 mm
OR-334-14	20.5 cm (8"), 14 mm
OR-334-19	20.5 cm (8"), 19 mm
OR-334-25	20.5 cm (8"), 25 mm

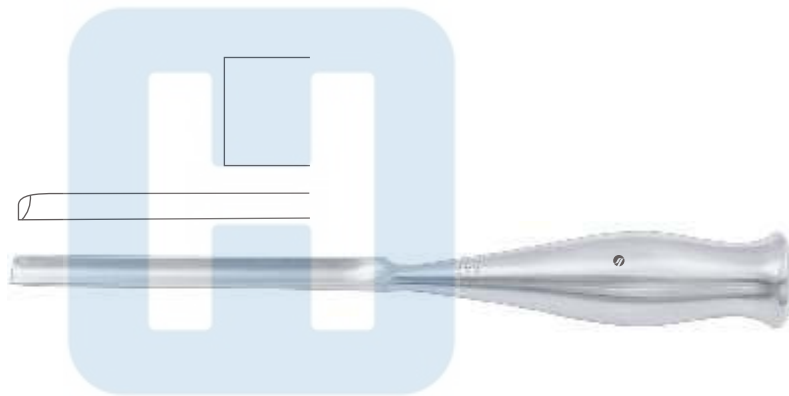

Smith-Peterson Bone Gouge
 Curved

Catalog #	Size, Blade Width
OR-335-09	20.5 cm (8"), 9 mm
OR-335-14	20.5 cm (8"), 14 mm
OR-335-19	20.5 cm (8"), 19 mm
OR-335-25	20.5 cm (8"), 25 mm

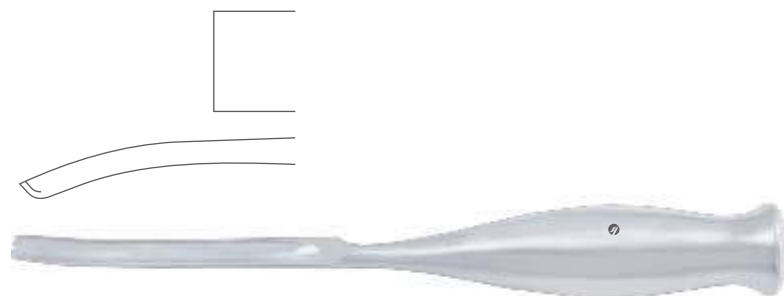

Osteotomes, Chisels
 Osteotome, Flachmeißel
 Osteótomos, Cinceles
 Ostéotomes, Ciseaux-burins
 Osteotomi, Scalpelli

Hoke Bone Osteotome

Catalog #	Size, Blade Width
OR-338-03	17 cm (6 3/4"), 3 mm
OR-338-05	17 cm (6 3/4"), 5 mm
OR-338-06	17 cm (6 3/4"), 6 mm
OR-338-08	17 cm (6 3/4"), 8 mm
OR-338-09	17 cm (6 3/4"), 9 mm



Hibbs Bone Osteotome

Catalog #	Size, Blade Width
OR-340-06	24.5 cm (9 3/4"), 6 mm
OR-340-13	24.5 cm (9 3/4"), 13 mm
OR-340-19	24.5 cm (9 3/4"), 19 mm
OR-340-25	24.5 cm (9 3/4"), 25 mm
OR-340-32	24.5 cm (9 3/4"), 32 mm

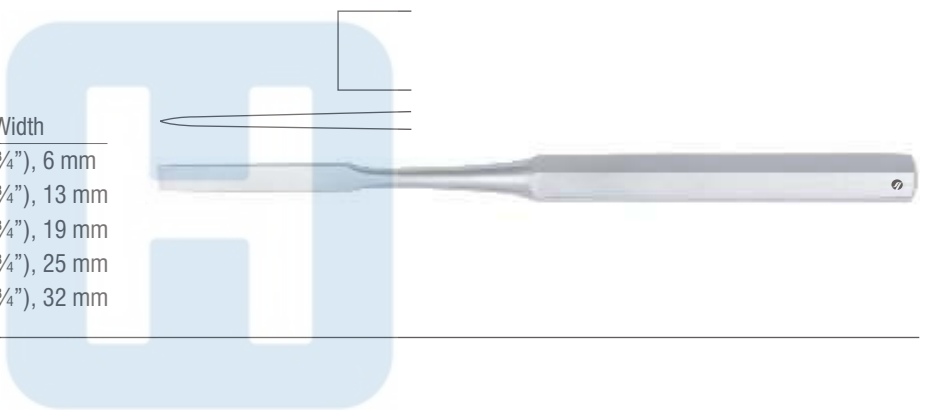

Hibbs Bone Osteotome Curved

Catalog #	Size, Blade Width
OR-341-06	24.5 cm (9 3/4"), 6 mm
OR-341-13	24.5 cm (9 3/4"), 13 mm
OR-341-19	24.5 cm (9 3/4"), 19 mm
OR-341-25	24.5 cm (9 3/4"), 25 mm
OR-341-32	24.5 cm (9 3/4"), 32 mm



Hibbs Bone Chisel

Catalog #	Size, Blade Width
OR-342-06	24.5 cm (9 3/4"), 6 mm
OR-342-13	24.5 cm (9 3/4"), 13 mm
OR-342-19	24.5 cm (9 3/4"), 19 mm
OR-342-25	24.5 cm (9 3/4"), 25 mm
OR-342-32	24.5 cm (9 3/4"), 32 mm



Gouges, Osteotomes
Hohlmeißel, Osteotome
Gubias, Osteótomos
Gouges, Osteótomes
Sgorbie, Osteotomi

Hibbs Bone Gouge Curved

Catalog #	Size, Blade Width
OR-343-06	24.5 cm (9 3/4"), 6 mm
OR-343-13	24.5 cm (9 3/4"), 13 mm
OR-343-19	24.5 cm (9 3/4"), 19 mm
OR-343-25	24.5 cm (9 3/4"), 25 mm
OR-343-32	24.5 cm (9 3/4"), 32 mm

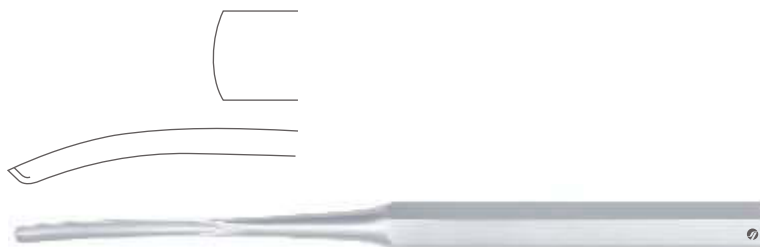

Hibbs Bone Gouge

Catalog #	Size, Blade Width
OR-344-06	24.5 cm (9 3/4"), 6 mm
OR-344-13	24.5 cm (9 3/4"), 13 mm
OR-344-19	24.5 cm (9 3/4"), 19 mm
OR-344-25	24.5 cm (9 3/4"), 25 mm
OR-344-32	24.5 cm (9 3/4"), 32 mm

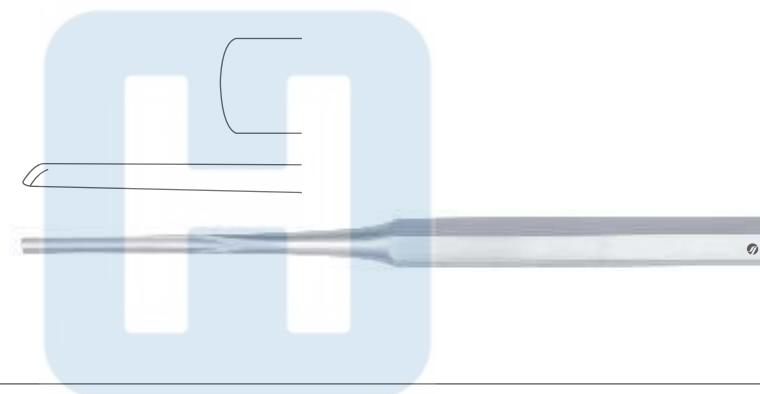

Cloward Bone Osteotome

Catalog #	Size, Blade Width
OR-346-05	24.5 cm (9 3/4"), 5 mm
OR-346-06	24.5 cm (9 3/4"), 6 mm
OR-346-07	24.5 cm (9 3/4"), 7 mm
OR-346-08	24.5 cm (9 3/4"), 8 mm
OR-346-10	24.5 cm (9 3/4"), 10 mm
OR-346-15	24.5 cm (9 3/4"), 15 mm



Gouges
Hohlmeißel
Gubias
Gouges
Sgorbie

Cloward Bone Gouge

Catalog #	Size, Blade Width
OR-348-05	24.5 cm (9 3/4"), 5 mm
OR-348-06	24.5 cm (9 3/4"), 6 mm
OR-348-07	24.5 cm (9 3/4"), 7 mm
OR-348-08	24.5 cm (9 3/4"), 8 mm
OR-348-10	24.5 cm (9 3/4"), 10 mm
OR-348-15	24.5 cm (9 3/4"), 15 mm



FiberGrip™ Lexer Bone Gouge

FIBERGrip™

Catalog #	Size, Blade Width
OR-356-05	25 cm (9 3/4"), 5 mm
OR-356-10	25 cm (9 3/4"), 10 mm
OR-356-15	25 cm (9 3/4"), 15 mm



FiberGrip™ Lexer Bone Gouge Curved

FIBERGrip™

Catalog #	Size, Blade Width
OR-357-05	25 cm (9 3/4"), 5 mm
OR-357-10	25 cm (9 3/4"), 10 mm
OR-357-15	25 cm (9 3/4"), 15 mm



FiberGrip™ Mini-Lexer Bone Osteotome

FIBERGrip™

Catalog #	Size, Blade Width
OR-360-04	18.5 cm (7 1/4"), 4 mm
OR-360-06	18.5 cm (7 1/4"), 6 mm
OR-360-08	18.5 cm (7 1/4"), 8 mm
OR-360-10	18.5 cm (7 1/4"), 10 mm
OR-360-12	18.5 cm (7 1/4"), 12 mm

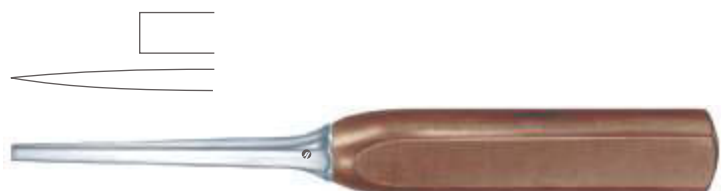

Gouges, Bone Chisels, Osteotomes
 Hohlmeißel, Knochenmeißel, Osteotome
 Gubias, Cinceles, Osteótomos
 Gouges, Ciseaux-burins, Ostéotomes
 Sgorbie, Scalpelli, Osteotomi

FiberGrip™ Mini-Lexer Bone Gouge

FIBERGrip™

Catalog #	Size, Blade Width
OR-362-04	18.5 cm (7 ¼"), 4 mm
OR-362-06	18.5 cm (7 ¼"), 6 mm
OR-362-08	18.5 cm (7 ¼"), 8 mm
OR-362-10	18.5 cm (7 ¼"), 10 mm
OR-362-12	18.5 cm (7 ¼"), 12 mm



FiberGrip™ Lexer Bone Chisel

FIBERGrip™

Catalog #	Size, Blade Width
OR-364-10	20 cm (8"), 10 mm
OR-364-15	20 cm (8"), 15 mm
OR-364-20	20 cm (8"), 20 mm



FiberGrip™ Lexer Bone Chisel Curved

FIBERGrip™

Catalog #	Size, Blade Width
OR-365-10	20 cm (8"), 10 mm
OR-365-15	20 cm (8"), 15 mm
OR-365-20	20 cm (8"), 20 mm

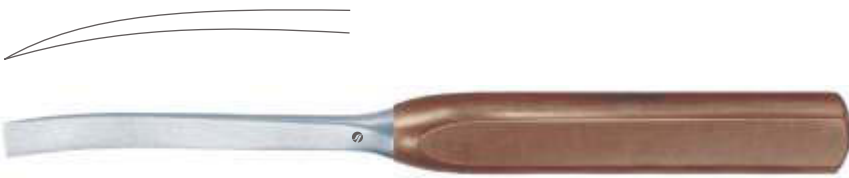

FiberGrip™ Lexer Bone Osteotome

FIBERGrip™

Catalog #	Size, Blade Width
OR-366-07	22 cm (8 ¾"), 7 mm
OR-366-10	22 cm (8 ¾"), 10 mm
OR-366-15	22 cm (8 ¾"), 15 mm
OR-366-20	22 cm (8 ¾"), 20 mm
OR-366-25	22 cm (8 ¾"), 25 mm
OR-366-30	22 cm (8 ¾"), 30 mm



Gouges, Bone Chisels, Osteotomes
 Hohlmeißel, Knochenmeißel, Osteotome
 Gubias, Cinceles, Osteótomos
 Gouges, Ciseaux-burins, Ostéotomes
 Sgorbie, Scalpelli, Osteotomi

FiberGrip™ Lexer Bone Gouge

FIBERGrip™

Catalog #	Size, Blade Width
OR-368-07	22 cm (8 3/4"), 7 mm
OR-368-10	22 cm (8 3/4"), 10 mm
OR-368-15	22 cm (8 3/4"), 15 mm
OR-368-20	22 cm (8 3/4"), 20 mm
OR-368-25	22 cm (8 3/4"), 25 mm
OR-368-30	22 cm (8 3/4"), 30 mm



FiberGrip™ Lexer Bone Osteotome Angled

FIBERGrip™

Catalog #	Size, Blade Width
OR-371-10	27.5 cm (10 3/4"), 10 mm
OR-371-15	27.5 cm (10 3/4"), 15 mm

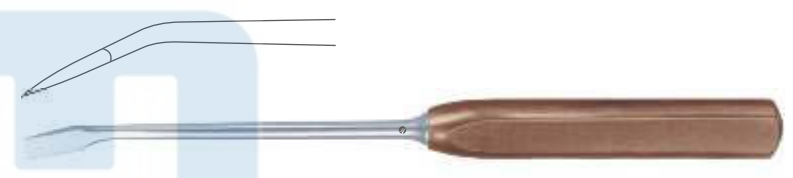

FiberGrip™ Lexer Bone Gouge Angled

FIBERGrip™

Catalog #	Size, Blade Width
OR-373-10	27.5 cm (10 3/4"), 10 mm
OR-373-15	27.5 cm (10 3/4"), 15 mm

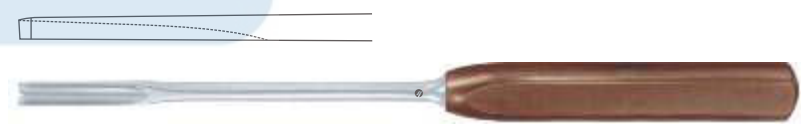

FiberGrip™ Bone Chisel

FIBERGrip™

Catalog #	Size, Blade Width
OR-376-24	24.5 cm (9 3/4"), 20 mm



FiberGrip™ Bone Chisel Curved

FIBERGrip™

Catalog #	Size, Blade Width
OR-377-26	26.5 cm (10 1/2"), 16 mm



Gouges
Hohlmeißel
Gubias
Gouges
Sgorbie

OR

BONE SURGERY

FiberGrip™ Wagner Bone Gouge
Sraight

FIBERGrip™



Catalog #	Size, Blade Width
OR-390-09	34 cm (13 1/2"), 9 mm
OR-390-15	34 cm (13 1/2"), 15 mm



FiberGrip™ Wagner Bone Gouge
Curved Forward

FIBERGrip™



Catalog #	Size, Blade Width
OR-391-09	34 cm (13 1/2"), 9 mm
OR-391-15	34 cm (13 1/2"), 15 mm



FiberGrip™ Wagner Bone Gouge
Curved Backward

FIBERGrip™



Catalog #	Size, Blade Width
OR-393-09	34 cm (13 1/2"), 9 mm
OR-393-15	34 cm (13 1/2"), 15 mm



FiberGrip™ Bone Gouge

FIBERGrip™

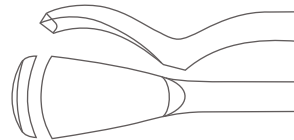

Catalog #	Size, Blade Width
OR-395-29	25 cm (9 3/4"), 25 mm



FiberGrip™ Cobb Bone Gouge

FIBERGrip™



Catalog #	Size, Blade Width
OR-398-28	28 cm (11"), 8 mm

Gouges
Hohlmeißel
Gubias
Gouges
Sgorbie

FiberGrip™ Cobb Bone Gouge

FIBERGrip™

Catalog #	Size, Blade Width
OR-399-01	28 cm (11"), 8 mm
OR-399-02	28 cm (11"), 8 mm
OR-399-03	28 cm (11"), 8 mm



FiberGrip™ Bone Gouge

FIBERGrip™

Catalog #	Size, Blade Width
OR-402-22	22 cm (8 3/4"), 9 mm



FiberGrip™ Zielke Bone Gouge

FIBERGrip™

Catalog #	Size, Blade Width
OR-405-55	23 cm (9"), 5.5 mm
OR-405-90	23.5 cm (9 1/4"), 9 mm

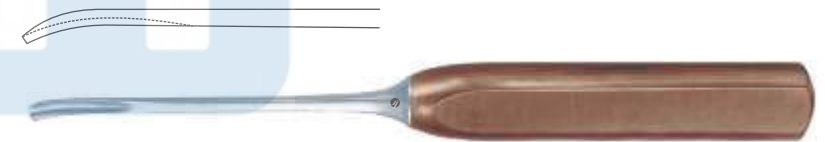

FiberGrip™ Zielke Bone Gouge

FIBERGrip™

Catalog #	Size, Blade Width
OR-407-06	23.5 cm (9 1/4"), 6 mm
OR-407-08?	23.5 cm (9 1/4"), 8 mm
OR-407-11	23.5 cm (9 1/4"), 11 mm
OR-407-16	23.5 cm (9 1/4"), 16 mm



Gouges
Hohlmeißel
Gubias
Gouges
Sgorbie

OR

BONE SURGERY

FiberGrip™ Dahmen Bone Osteotome

FIBER Grip™

Catalog #	Size, Blade Width
OR-410-04	30 cm (12"), 4 mm
OR-410-05	30 cm (12"), 5 mm
OR-410-06?	30 cm (12"), 6 mm
OR-410-08	30 cm (12"), 8 mm
OR-410-10	30 cm (12"), 10 mm
OR-410-12	30 cm (12"), 12 mm
OR-410-15?	30 cm (12"), 15 mm
OR-410-20	30 cm (12"), 20 mm
OR-410-22	30 cm (12"), 22 mm
OR-410-25	30 cm (12"), 25 mm



FiberGrip™ Dahmen Bone Osteotome Curved

FIBER Grip™

Catalog #	Size, Blade Width
OR-411-04	30 cm (12"), 4 mm
OR-411-05	30 cm (12"), 5 mm
OR-411-06?	30 cm (12"), 6 mm
OR-411-08	30 cm (12"), 8 mm
OR-411-10	30 cm (12"), 10 mm
OR-411-12	30 cm (12"), 12 mm
OR-411-15?	30 cm (12"), 15 mm
OR-411-20	30 cm (12"), 20 mm
OR-411-22	30 cm (12"), 22 mm
OR-411-25	30 cm (12"), 25 mm



Gouges, Bone Rasps
 Hohlmeißel, Knochenraspeln
 Gubias, Escofinas para hueso
 Gouges, Râpes pour os
 Sgorbie, Raspe per ossa

FiberGrip™ Dahmen Bone Gouge

FIBERGrip™

Catalog #	Size, Blade Width
OR-412-04	30 cm (12"), 4 mm
OR-412-05	30 cm (12"), 5 mm
OR-412-06?	30 cm (12"), 6 mm
OR-412-08	30 cm (12"), 8 mm
OR-412-10	30 cm (12"), 10 mm
OR-412-12	30 cm (12"), 12 mm
OR-412-15?	30 cm (12"), 15 mm
OR-412-20	30 cm (12"), 20 mm
OR-412-22	30 cm (12"), 22 mm
OR-412-25	30 cm (12"), 25 mm

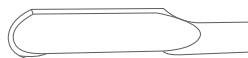

FiberGrip™ Dahmen Bone Gouge Curved

FIBERGrip™

Catalog #	Size, Blade Width
OR-413-04	30 cm (12"), 4 mm
OR-413-05	30 cm (12"), 5 mm
OR-413-06?	30 cm (12"), 6 mm
OR-413-08	30 cm (12"), 8 mm
OR-413-10	30 cm (12"), 10 mm
OR-413-12	30 cm (12"), 12 mm
OR-413-15?	30 cm (12"), 15 mm
OR-413-20	30 cm (12"), 20 mm
OR-413-22	30 cm (12"), 22 mm
OR-413-25	30 cm (12"), 25 mm

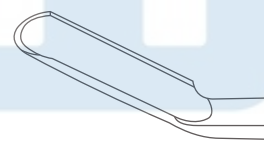

Putti Bone Rasp
 Round, Semi Round

Catalog #	Size
OR-421-30	30 cm (11 3/4")



Bone Rasps, Tampers
 Knochenraspeln, Stößel
 Escofinas para hueso, Punzones metálicos
 Râpes pour os, Pignons métalliques
 Raspe per ossa, Pestoni metallici

Putti Bone Rasp
 Curved, Straight

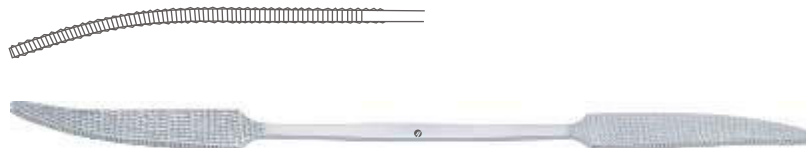

Catalog #	Size
OR-423-27	27 cm (10 3/4")

Bone File
 Semi Round

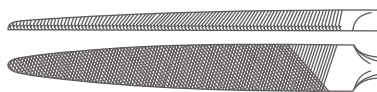

Catalog #	Size
OR-426-28	28 cm (11")

Bone File
 Semi Round



Catalog #	Size
OR-427-24	24.5 cm (9 3/4")

Bone File
 Flat



Catalog #	Size
OR-430-22	22 cm (8 3/4")

Tampers, Mallets
 Stößel, Hämmer
 Punzones metálicos, Martillos
 Piloni métalliques, Maillets
 Pestoni metallici, Martelli

Passow Bone Tamper



Catalog #	Size, Tip Size
OR-438-25	12 cm (4 3/4"), 2.5 mm
OR-438-35	12 cm (4 3/4"), 3.5 mm



Bone Tamper

Catalog #	Size, Diameter
OR-440-02	15 cm (6"), Ø 2.0 mm
OR-440-03	15 cm (6"), Ø 3.0 mm
OR-440-04	15 cm (6"), Ø 4.0 mm
OR-440-05	15 cm (6"), Ø 5.0 mm
OR-440-06	15 cm (6"), Ø 6.0 mm
OR-440-08	15 cm (6"), Ø 8.0 mm
OR-440-10	15 cm (6"), Ø 10.0 mm



Caspar Bone Tamper

Catalog #	Size, Diameter
OR-442-03	20 cm (8"), Ø 2.0 mm
OR-442-05	20 cm (8"), Ø 5.0 mm
OR-442-08	20 cm (8"), Ø 8.0 mm



Bone Tamper

Catalog #	Size, Diameter
OR-444-12	20 cm (8"), Ø 12.0 mm
OR-444-14	20 cm (8"), Ø 14.0 mm
OR-444-16	20 cm (8"), Ø 16.0 mm



Williger Bone Mallet

Lead Filled



Catalog #	Size, Head Diameter, Weight
OR-450-01	24 cm (9 1/2"), Ø 26.0 mm, 300 Grams
OR-450-02	24 cm (9 1/2"), Ø 28.0 mm, 340 Grams
OR-450-03	24 cm (9 1/2"), Ø 30.0 mm, 400 Grams



Doyen Bone Mallet

Catalog #	Size, Head Diameter, Weight
OR-452-01	20.5 cm (8"), Ø 25.0 mm, 120 Grams
OR-452-02	21 cm (8 1/4"), Ø 30.0 mm, 180 Grams
OR-452-03	21.5 cm (8 1/2"), Ø 35.0 mm, 260 Grams

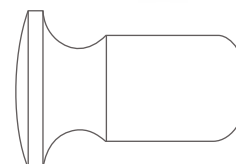

Collin Bone Mallet

Catalog #	Size, Head Diameter, Weight
OR-454-20	20 cm (8"), Ø 30.0 mm, 220 Grams



Hajek Bone Mallet

Catalog #	Size, Head Diameter, Weight
OR-458-21	2.5 cm (8 1/2"), Ø 27.0 mm, 140 Grams



Gerzog Bone Mallet

Catalog #	Size, Head Diameter, Weight
OR-460-17	19 cm (7 1/2"), Ø 25.0 mm, 225 Grams



Mallets
Hämmer
Martillos
Maillets
Martelli

Lucae Bone Mallet

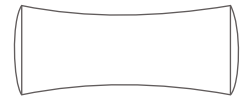

Catalog #	Size, Head Diameter, Weight
OR-462-01	19.5 cm (7 3/4"), Ø 19.0 mm, 230 Grams
OR-462-02	19.5 cm (7 3/4"), Ø 25.0 mm, 260 Grams

Bergmann Bone Mallet



Catalog #	Size, Head Diameter, Weight
OR-464-24	24 cm (9 1/2"), Ø 45.0 mm, 300 Grams

Bergmann Bone Mallet



Catalog #	Size, Head Diameter, Weight
OR-466-24	23.5 cm (9 1/4"), Ø 30.0 mm, 245 Grams

Bone Mallet



Catalog #	Size, Head Diameter 1, Head Diameter, Weight
OR-468-24	24 cm (9 1/2"), Ø 30.0 mm, Ø 42.0 mm, 285 Grams

Cottle Bone Mallet
Plain, Convex



Catalog #	Size, Head Diameter, Weight
OR-470-19	19 cm (7 1/2"), Ø 30.0 mm, 300 Grams

Tampers, Mallets
 Stößel, Hämmer
 Punzones metálicos, Martillos
 Pilonis métalliques, Maillets
 Pestoni metallici, Martelli

Omberdanne Bone Mallet



Catalog #	Size, Head Diameter, Weight
OR-472-24	24 cm (9 1/2"), Ø 40.0 mm, 520 Grams

Heath Bone Mallet



Catalog #	Size, Head Diameter, Weight
OR-474-18	18.5 cm (7 1/4"), Ø 40.0 mm, 660 Grams
OR-474-20	20 cm (8"), Ø 45.0 mm, 725 Grams

Williger Bone Mallet



Catalog #	Size, Head Diameter, Weight
OR-476-16	16.5 cm (6 1/2"), Ø 20.0 mm, 140 Grams

Mead Bone Mallet

With Interchangeable Plastic Discs



Catalog #	Size, Head Diameter, Weight
OR-478-16	19 cm (7 1/2"), Ø 27.0 mm, 320 Grams

Mallet Spare Plastic Discs

Pair, Plastic



Catalog #	Size
OR-478-90	Standard

Mallets
Hämmer
Martillos
Maillets
Martelli

Partsch Mallet
With Hollow Handle



Catalog #	Size, Head Diameter, Weight
OR-480-18	19 cm (7 1/2"), Ø 22.0 mm, 200 Grams

FiberGrip™ Bone Mallet
With Plastic Handle

FIBERGrip™



Catalog #	Size, Head Diameter, Weight
OR-486-22	26 cm (10 1/4"), Ø 30.0 mm, 510 Grams

FiberGrip™ Bone Mallet
With Lead Filling, Ferrozell

FIBERGrip™



Catalog #	Size, Head Diameter, Weight
OR-488-01	26 cm (10 1/4"), Ø 42.0 mm, 400 Grams

FiberGrip™ Bone Mallet
Without Lead Filling, Ferrozell

FIBERGrip™



Catalog #	Size, Head Diameter, Weight
OR-488-02	26 cm (10 1/4"), Ø 42.0 mm, 250 Grams

FiberGrip™ Bone Mallet
With Lead Filling, Ferrozell

FIBERGrip™



Catalog #	Size, Head Diameter, Weight
OR-490-26	26 cm (10 1/4"), Ø 42.0 mm, 400 Grams

Mallets
Hämmer
Martillos
Maillets
Martelli

OR

BONE SURGERY

FiberGrip™ Bone Mallet

Plane (Nylon), Convex (Stainless Steel)

FIBERGrip™

Catalog #	Size, Head Diameter, Weight
OR-492-29	26.5 cm (10 1/2"), Ø 30.0 mm, 675 Grams



FiberGrip™ Bone Mallet

FIBERGrip™

Catalog #	Size, Head Diameter 1, Head Diameter 2, Weight
OR-494-24	26 cm (10 1/4"), Ø 42.0 mm, 30.0 mm, 530 Grams



FiberGrip™ Bone Mallet

FIBERGrip™

Catalog #	Size, Head Diameter, Weight
OR-496-24	24 cm (9 1/2"), Ø 30.0 mm, 480 Grams



FiberGrip™ Bone Mallet

With Interchangeable Plastic Discs

FIBERGrip™

Catalog #	Size, Head Diameter, Weight
OR-498-22	24 cm (9 1/2"), Ø 37.0 mm, 370 Grams



Mallet Spare Plastic Discs

Pair, Plastic

Catalog #	Size
OR-498-90	Standard



Mallets
Hämmer
Martillos
Maillets
Martelli

FiberGrip™ Bone Mallet

FIBERGrip™



Catalog #	Size, Head Diameter, Weight
OR-500-18	22 cm (8 ¾"), Ø 30.0 mm, 125 Grams

FiberGrip™ Bone Mallet

FIBERGrip™



Catalog #	Size, Head Diameter, Weight
OR-502-01	26 cm (10 ½"), Ø 30.0 mm, 450 Grams
OR-502-02	26 cm (10 ½"), Ø 50.0 mm, 900 Grams

FiberGrip™ Vickers Bone Mallet
With Interchangeable Nylon Discs

FIBERGrip™



Catalog #	Size, Head Diameter, Weight
OR-504-19	19 cm (7 ½"), Ø 25.0 mm, 300 Grams

Mallet Spare Plastic Discs
Pair, Plastic

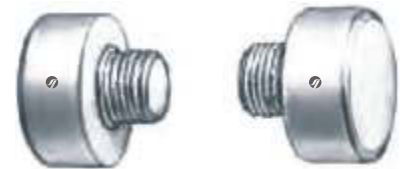

Catalog #	Size
OR-504-90	Standard

FiberGrip™ Herbert Bone Mallet

FIBERGrip™



Catalog #	Size
OR-506-19	19 cm (7 ½")

Bone Curettes
Scharfe Löffel
Cucharillas cortantes
Curettes tranchantes
Curette taglianti

OR

BONE SURGERY

FiberGrip™ Volkmann Bone Curette
Oval

FIBERGrip™

Catalog #	Size, Profile
OR-520-40	18.5 cm (7 ¼"), Fig. 0000
OR-520-30	18.5 cm (7 ¼"), Fig. 000
OR-520-20	18.5 cm (7 ¼"), Fig. 00
OR-520-10	18.5 cm (7 ¼"), Fig. 0
OR-520-01	18.5 cm (7 ¼"), Fig. 1
OR-520-02	18.5 cm (7 ¼"), Fig. 2
OR-520-03	19 cm (7 ½"), Fig. 3
OR-520-04	19 cm (7 ½"), Fig. 4
OR-520-05	19 cm (7 ½"), Fig. 5
OR-520-06	19 cm (7 ½"), Fig. 6



FiberGrip™ Volkmann Bone Curette
Oval

FIBERGrip™

Catalog #	Size, Profile
OR-522-10	27.5 cm (10 ¾"), Fig. 4
OR-522-01	27.5 cm (10 ¾"), Fig. 0
OR-522-02	27.5 cm (10 ¾"), Fig. 1
OR-522-03	27.5 cm (10 ¾"), Fig. 2
OR-522-04	27.5 cm (10 ¾"), Fig. 3



Schede Bone Curette
Oval

Catalog #	Size, Scoop Size, Profile
OR-524-30	17 cm (6 ¾"), 2.5 mm, Fig. 000
OR-524-20	17 cm (6 ¾"), 3.4 mm, Fig. 00
OR-524-10	17 cm (6 ¾"), 4.2 mm, Fig. 0
OR-524-01	17 cm (6 ¾"), 5.2 mm, Fig. 1
OR-524-02	17 cm (6 ¾"), 6.3 mm, Fig. 2
OR-524-03	17 cm (6 ¾"), 7.4 mm, Fig. 3
OR-524-04	17 cm (6 ¾"), 8 mm, Fig. 4



Bone Curettes
Scharfe Löffel
Cucharillas cortantes
Curettes tranchantes
Curette taglienti

Volkman Bone Curette
Oval

Catalog #	Size, Scoop Size, Profile
OR-526-40	17 cm (6 3/4"), 2.8 mm, Fig. 0000
OR-526-30	17 cm (6 3/4"), 3.6 mm, Fig. 000
OR-526-20	17 cm (6 3/4"), 4.4 mm, Fig. 00
OR-526-10	17 cm (6 3/4"), 5.2 mm, Fig. 0
OR-526-01	17 cm (6 3/4"), 6.8 mm, Fig. 1
OR-526-02	17 cm (6 3/4"), 8.5 mm, Fig. 2
OR-526-03	17 cm (6 3/4"), 10 mm, Fig. 3
OR-526-04	17 cm (6 3/4"), 11.5 mm, Fig. 4
OR-526-05	17 cm (6 3/4"), 13 mm, Fig. 5
OR-526-06	17 cm (6 3/4"), 14.5 mm, Fig. 6



Bruns Bone Curette
Round

Catalog #	Size, Scoop Size, Profile
OR-528-30	17 cm (6 3/4"), 3 mm, Fig. 000
OR-528-20	17 cm (6 3/4"), 4 mm, Fig. 00
OR-528-10	17 cm (6 3/4"), 5 mm, Fig. 0
OR-528-01	17 cm (6 3/4"), 6 mm, Fig. 1
OR-528-02	17 cm (6 3/4"), 8 mm, Fig. 2
OR-528-03	17 cm (6 3/4"), 10 mm, Fig. 3
OR-528-04	17 cm (6 3/4"), 12 mm, Fig. 4



Spratt Bone Curette
Oval

Catalog #	Size, Profile
OR-530-40	17 cm (6 3/4"), Fig. 0000
OR-530-30	17 cm (6 3/4"), Fig. 000
OR-530-20	17 cm (6 3/4"), Fig. 00
OR-530-10	17 cm (6 3/4"), Fig. 0
OR-530-01	17 cm (6 3/4"), Fig. 1
OR-530-02	17 cm (6 3/4"), Fig. 2
OR-530-03	17 cm (6 3/4"), Fig. 3
OR-530-04	17 cm (6 3/4"), Fig. 4
OR-530-05	17 cm (6 3/4"), Fig. 5



Bone Curettes
Scharfe Löffel
Cucharillas cortantes
Curettes tranchantes
Curette taglianti

OR

BONE SURGERY

Bruns Bone Curette
Oval, Solid Handle

Catalog #	Size, Scoop Size, Profile
OR-532-30	23 cm (9"), 2.0 mm, Fig. 000
OR-532-20	23 cm (9"), 2.5 mm, Fig. 00
OR-532-10	23 cm (9"), 3.3 mm, Fig. 0
OR-532-01	23 cm (9"), 3.8 mm, Fig. 1
OR-532-02	23 cm (9"), 4.8 mm, Fig. 2
OR-532-03	23 cm (9"), 5.3 mm, Fig. 3
OR-532-04	23 cm (9"), 6.0 mm, Fig. 4
OR-532-05	23 cm (9"), 6.7 mm, Fig. 5
OR-532-06	23 cm (9"), 7.3 mm, Fig. 6



Scoville Bone Curette
Oval

Catalog #	Size, Scoop Size, Profile
OR-534-30	25 cm (9 3/4"), 3.6 mm, Fig. 000
OR-534-20	25 cm (9 3/4"), 4.4 mm, Fig. 00
OR-534-10	25 cm (9 3/4"), 6.8 mm, Fig. 0
OR-534-01	25 cm (9 3/4"), 5.2 mm, Fig. 1

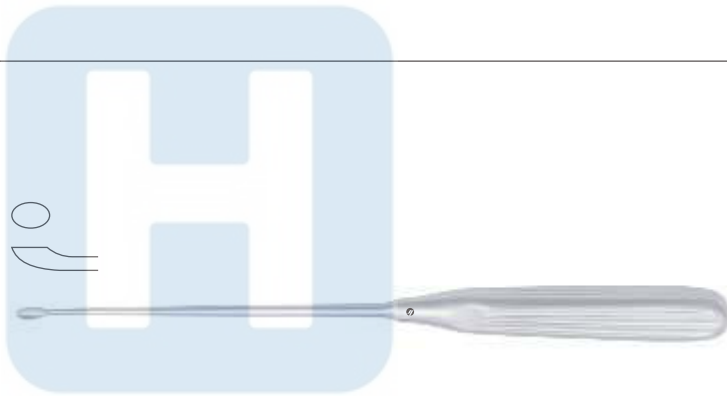

Scoville Bone Curette
Oval, Curved Downwards

Catalog #	Size, Scoop Size, Profile
OR-535-30	25 cm (9 3/4"), 3.6 mm, Fig. 000
OR-535-20	25 cm (9 3/4"), 4.4 mm, Fig. 00
OR-535-10	25 cm (9 3/4"), 5.2 mm, Fig. 0
OR-535-01	25 cm (9 3/4"), 6.8 mm, Fig. 1



Bone Curettes
Scharfe Löffel
Cucharillas cortantes
Curettes tranchantes
Curette taglianti

Scoville Bone Curette
Oval, Curved Upwards



Catalog #	Size, Scoop Size
OR-537-01	25 cm (9 3/4"), 4mm
OR-537-02	25 cm (9 3/4"), 3mm
OR-537-03	25 cm (9 3/4"), 5 mm

Simon Bone Curette
Oval



Catalog #	Size, Scoop Size, Profile
OR-538-30	25 cm (9 3/4"), 3.6 mm, Fig. 000
OR-538-20	25 cm (9 3/4"), 4.4 mm, Fig. 00
OR-538-10	25 cm (9 3/4"), 5.2 mm, Fig. 0
OR-538-01	25 cm (9 3/4"), 6.8 mm, Fig. 1
OR-538-02	25 cm (9 3/4"), 8.5 mm, Fig. 2
OR-538-03	25 cm (9 3/4"), 10 mm, Fig. 3
OR-538-04	25 cm (9 3/4"), 11.5 mm, Fig. 4
OR-538-05	25 cm (9 3/4"), 13 mm, Fig. 5
OR-538-06	25 cm (9 3/4"), 14.5 mm, Fig. 6

Caspar Bone Curette
Rectangular, Toothed



Catalog #	Size, Scoop Size
OR-540-01	25 cm (9 3/4"), 4 mm
OR-540-02	25 cm (9 3/4"), 5 mm

Caspar Bone Curette
Angled, Rectangular, Toothed



Catalog #	Size, Scoop Size
OR-541-01	27 cm (10 3/4"), 3 mm
OR-541-02	27 cm (10 3/4"), 4 mm

Bone Curettes
Scharfe Löffel
Cucharillas cortantes
Curettes tranchantes
Curette taglianti

OR

BONE SURGERY

Hatfield Bone Curette
Oval

Catalog #	Size, Scoop Size
OR-542-01	23 cm (9"), 5.0 mm
OR-542-02	23 cm (9"), 5.5 mm
OR-542-03	23 cm (9"), 6.4 mm
OR-542-04	23 cm (9"), 8.0 mm
OR-542-05	23 cm (9"), 9.0 mm
OR-542-06	23 cm (9"), 11.0 mm
OR-542-07	23 cm (9"), 12.5 mm
OR-542-08	23 cm (9"), 14.5 mm
OR-542-09	23 cm (9"), 16.8 mm



Cobb Bone Curette
Oval

Catalog #	Size, Scoop Size
OR-544-01	28 cm (11"), 5.0 mm
OR-544-02	28 cm (11"), 6.3 mm
OR-544-03	28 cm (11"), 7.6 mm
OR-544-04	28 cm (11"), 8.9 mm
OR-544-05	28 cm (11"), 10.2 mm
OR-544-06	28 cm (11"), 11.4 mm
OR-544-07	28 cm (11"), 12.7 mm
OR-544-08	28 cm (11"), 14.0 mm
OR-544-09	28 cm (11"), 15.2 mm



Modell USA Bone Curette
Oval

Catalog #	Size, Profile
OR-546-01	16 cm (6 1/4"), Fig. 1
OR-546-02	16 cm (6 1/4"), Fig. 2
OR-546-03	16 cm (6 1/4"), Fig. 3
OR-546-04	16 cm (6 1/4"), Fig. 4
OR-546-05	16 cm (6 1/4"), Fig. 5
OR-546-06	16 cm (6 1/4"), Fig. 6



Bone Curettes
Scharfe Löffel
Cucharillas cortantes
Curettes tranchantes
Curette taglianti

Modell USA Bone Curette
Oval, Left



Catalog #	Size, Profile
OR-547-01	15.5 cm (6"), Fig. 1
OR-547-02	15.5 cm (6"), Fig. 2
OR-547-03	15.5 cm (6"), Fig. 3
OR-547-04	15.5 cm (6"), Fig. 4
OR-547-05	15.5 cm (6"), Fig. 5
OR-547-06	15.5 cm (6"), Fig. 6

Modell USA Bone Curette
Oval, Right



Catalog #	Size, Profile
OR-548-01	15.5 cm (6"), Fig. 1
OR-548-02	15.5 cm (6"), Fig. 2
OR-548-03	15.5 cm (6"), Fig. 3
OR-548-04	15.5 cm (6"), Fig. 4
OR-548-05	15.5 cm (6"), Fig. 5
OR-548-06	15.5 cm (6"), Fig. 6

Halle Bone Curette
Oval



Catalog #	Size, Scoop Size, Profile
OR-549-01	21 cm (8 1/4"), 4.4 mm, Fig. 000
OR-549-02	21 cm (8 1/4"), 5.2 mm, Fig. 00
OR-549-03	21 cm (8 1/4"), 6.8 mm, Fig. 0

Daubenspeck Bone Curette
Oval



Catalog #	Size, Scoop Size, Profile
OR-550-40	20 cm (8"), 2.8 mm, Fig 0000
OR-550-30	20 cm (8"), 3.6 mm, Fig 000
OR-550-20	20 cm (8"), 4.4 mm, Fig 00
OR-550-10	20 cm (8"), 5.2 mm, Fig 0

Bone Curettes
Scharfe Löffel
Cucharillas cortantes
Curettes tranchantes
Curette taglianti

Volkman Bone Curette
Double Ended, Oval/Oval



Catalog #	Size
OR-552-13	12.5 cm (5")
OR-552-14	14.5 cm (5 ¾")
OR-552-17	17 cm (6 ¾")

Volkman Bone Curette
Double Ended, Round/Oval



Catalog #	Size
OR-554-13	13 cm (5")
OR-554-16	16 cm (6 ¼")
OR-554-20	20 cm (8")

Bone Curette
Double Ended, Round/Oval



Catalog #	Size
OR-556-21	21 cm (8 ¼")

Williger Bone Curette
Double Ended, Oval/Oval



Catalog #	Size, Profile
OR-558-00	13.5 cm (5 ¼"), Fig. 00 / Fig. 0
OR-558-01	13.5 cm (5 ¼"), Fig. 0 / Fig. 1
OR-558-12	13.5 cm (5 ¼"), Fig. 1 / Fig. 2

Bone Curettes
 Scharfe Löffel
 Cucharillas cortantes
 Curettes tranchantes
 Curette taglienti

Williger Bone Curette
 Double Ended, Oval/Oval

Catalog #	Size, Profile
OR-559-00	17 cm (6 3/4"), Fig. 00 / Fig. 0
OR-559-10	17 cm (6 3/4"), Fig. 0 / Fig. 1
OR-559-11	17 cm (6 3/4"), Fig. 1 / Fig. 2



Bone Curette

Catalog #	Size
OR-561-16	16 cm (6 1/4")



Jansen Bone Curette

Catalog #	Size
OR-563-16	16 cm (6 1/4")



Hemingway Bone Curette

Catalog #	Size
OR-565-16	17 cm (6 3/4")



Hemingway Bone Curette

Catalog #	Size
OR-567-17	17 cm (6 3/4")

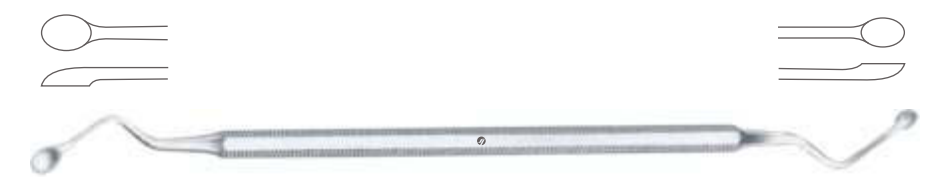

Bone Curettes
Scharfe Löffel
Cucharillas cortantes
Curettes tranchantes
Curette taglianti

Hemingway Bone Curette

Catalog #	Size, Profile
OR-569-00	17 cm (6 3/4"), Fig. 0
OR-569-01	17 cm (6 3/4"), Fig. 1
OR-569-02	17 cm (6 3/4"), Fig. 2
OR-569-03	17 cm (6 3/4"), Fig. 3
OR-569-04	17 cm (6 3/4"), Fig. 4



Lucas Bone Curette

Catalog #	Size
OR-571-18	18 cm (7")



Lucas Bone Curette

Catalog #	Size
OR-573-18	18.5 cm (7 1/4")



Kerpel Bone Curette

Oval, Left

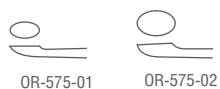

Catalog #	Size
OR-575-01	14.5 cm (5 3/4")
OR-575-02	14.5 cm (5 3/4")



Kerpel Bone Curette

Oval, Right



Catalog #	Size
OR-577-01	14.5 cm (5 3/4")
OR-577-02	14.5 cm (5 3/4")



Bone Curettes, Periosteal Elevators
 Scharfe Löffel, Raspatorien
 Cucharillas cortantes, Periostótomos
 Curettes tranchantes, Rugines-raspatoires
 Curette taglianti, Periostotomi

Molt Bone Curette

Catalog #	Size, Profile
OR-580-01	17 cm (6 3/4"), Fig. 1
OR-580-02	17 cm (6 3/4"), Fig. 2
OR-580-03	17 cm (6 3/4"), Fig. 3
OR-580-04	17 cm (6 3/4"), Fig. 4
OR-580-05	17.5 cm (7"), Fig. 5
OR-580-06	17.5 cm (7"), Fig. 6

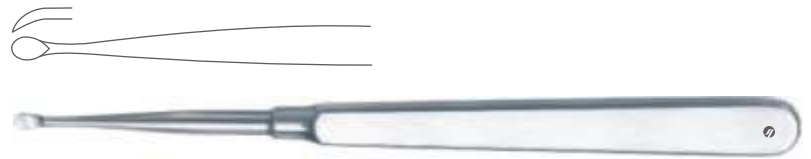

**Molt Bone Curette
 Round Handle**

Catalog #	Size
OR-582-24	19 cm (7 1/2")

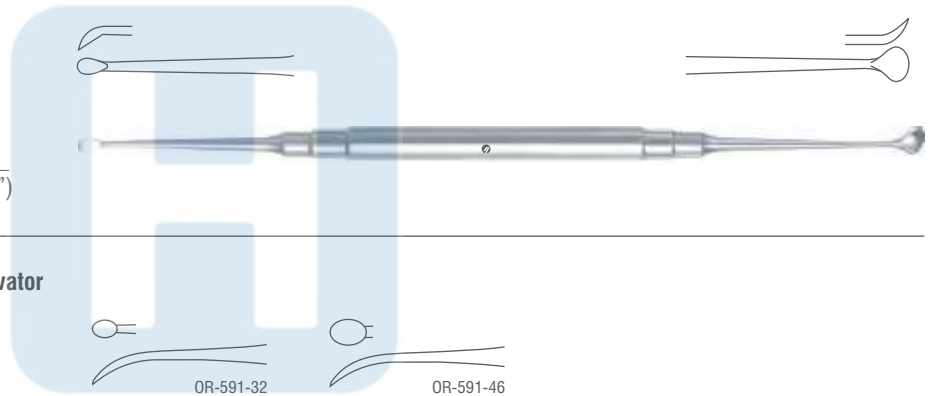

Partsch Periosteal Raspatory / Elevator

Catalog #	Size, Width
OR-591-32	15 cm (6"), 3.2 mm
OR-591-46	15 cm (6"), 3.2 mm

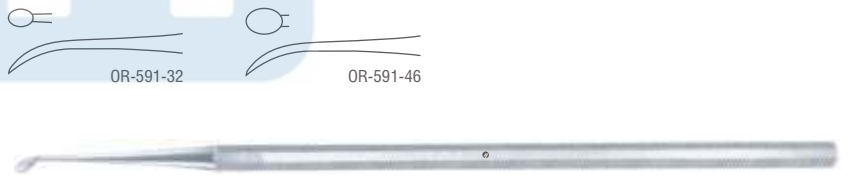

Partsch Mod. Lange Periosteal Raspatory / Elevator

Catalog #	Size, Width
OR-593-15	14.5 cm (5 3/4"), 4.0 mm



Koenig Periosteal Raspatory / Elevator

Catalog #	Size
OR-595-15	15.5 cm (6")



Periosteal Elevators
 Raspatorien
 Periostótomos
 Rugines-raspatoires
 Periostotomi

OR

BONE SURGERY

Trelat Periosteal Raspatory / Elevator



Catalog #	Size
OR-597-15	15.5 cm (6")

Ward Periosteal Raspatory / Elevator



Catalog #	Size
OR-599-17	17 cm (6 3/4")

Sewall Periosteal Raspatory / Elevator



Catalog #	Size
OR-601-20	20 cm (8")

Mead Periosteal Raspatory / Elevator



Catalog #	Size
OR-602-16	16.5 cm (6 1/2")

Molt Periosteal Raspatory / Elevator



Catalog #	Size
OR-603-18	18 cm (7")

Periosteal Elevators
 Raspatorien
 Periostótomos
 Rugines-raspatoires
 Periostotomi

Syme Periosteal Raspatory / Elevator



Catalog #	Size, Width
OR-605-18	18.5 cm (7 1/4"), 4 mm

Roberts Periosteal Raspatory / Elevator

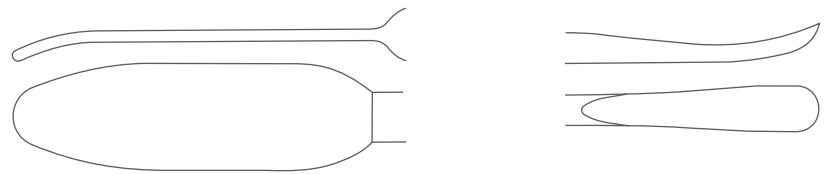

Catalog #	Size
OR-607-18	18.5 cm (7 1/4")

Seldin Periosteal Raspatory / Elevator



Catalog #	Size
OR-609-19	19.5 cm (7 3/4")

Seldin Periosteal Raspatory / Elevator

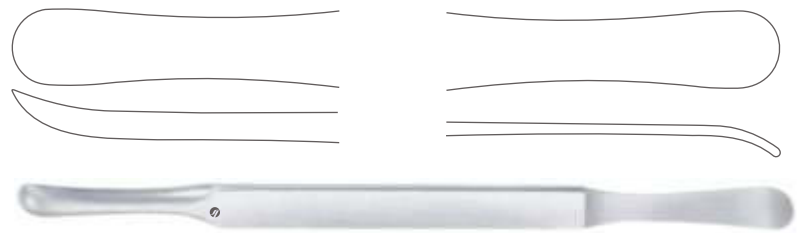

Catalog #	Size
OR-611-19	19.5 cm (7 3/4")

Cottle Periosteal Raspatory / Elevator

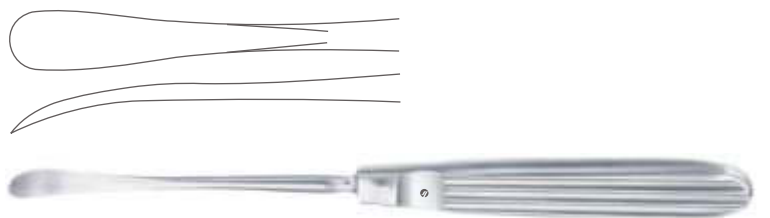

Catalog #	Size, Width
OR-613-19	19.5 cm (7 3/4"), 8 mm

Periosteal Elevators
 Raspatorien
 Periostótomos
 Rugines-raspatoires
 Periostotomi

OR

BONE SURGERY

Landolt Periosteal Raspatory / Elevator

Catalog #	Size
OR-615-17	17.5 cm (7")

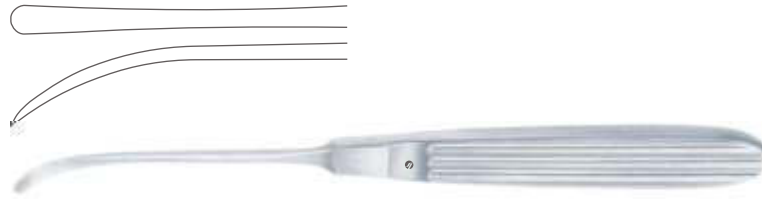

Caspar Periosteal Raspatory / Elevator

Catalog #	Size
OR-617-18	18 cm (7")

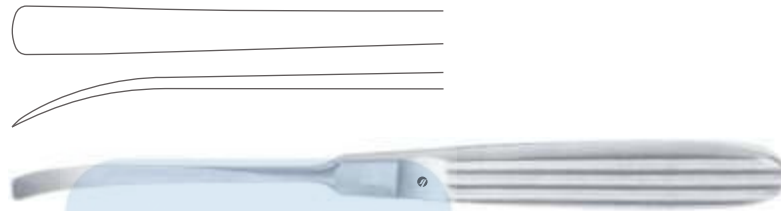

Sedillot Periosteal Raspatory / Elevator

Catalog #	Size, Width
OR-619-18	18.5 cm (7 1/4"), 18 mm

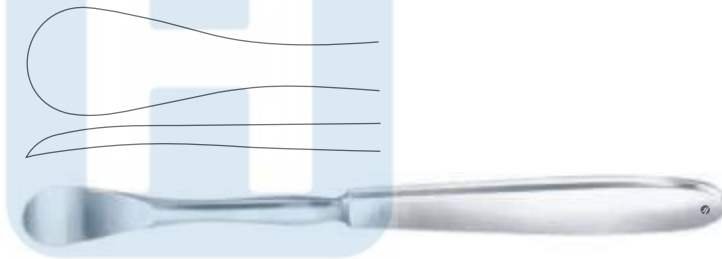

McKissock Periosteal Raspatory / Elevator

Catalog #	Size, Width
OR-620-19	19.5 cm (7 3/4"), 11 mm



Kraemer Periosteal Raspatory / Elevator

Catalog #	Size, Width
OR-621-18	18.5 cm (7 1/4"), 10 mm

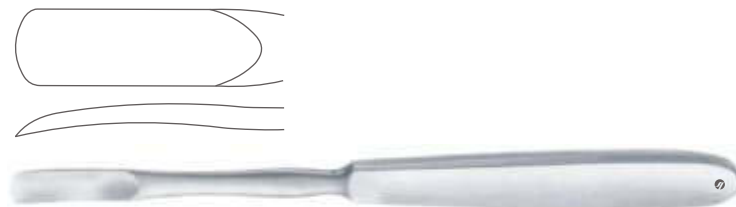

Periosteal Elevators
 Raspatorien
 Periostótomos
 Rugines-raspatoires
 Periostotomi

Kraemer Periosteal Raspatory / Elevator

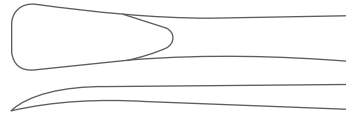

Catalog #	Size, Width
OR-623-19	19 cm (7 1/2"), 10 mm



Pennybaker Periosteal Raspatory / Elevator
 Blunt

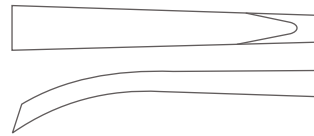

Catalog #	Size, Width
OR-625-16	16.5 cm (6 1/2"), 6 mm



Buchs Periosteal Raspatory / Elevator

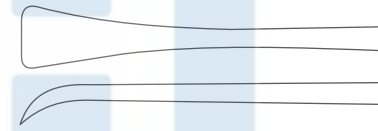

Catalog #	Size, Width
OR-627-19	19 cm (7 1/2"), 9.5 mm



Jansen Periosteal Raspatory / Elevator

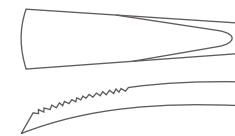

Catalog #	Size, Width
OR-629-16	16.5 cm (6 1/2"), 15 mm



Key Periosteal Raspatory / Elevator



Catalog #	Size, Width
OR-631-06	18 cm (7"), 6 mm
OR-631-10	19 cm (7 1/2"), 10 mm
OR-631-13	19 cm (7 1/2"), 13 mm
OR-631-19	20 cm (8"), 19 mm
OR-631-25	21 cm (8 1/4"), 25 mm



Periosteal Elevators
 Raspatorien
 Periostótomos
 Rugines-raspatoires
 Periostotomi

Langenbeck Periosteal Raspatory / Elevator

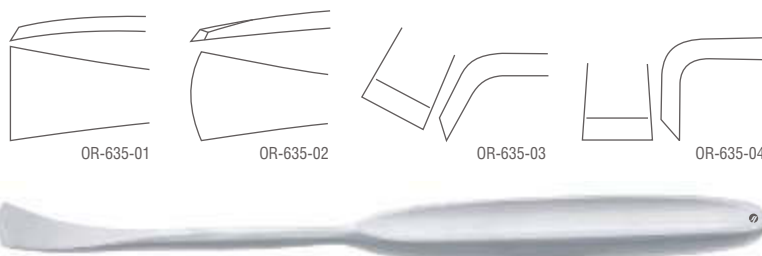

Catalog #	Size, Width
OR-635-01	19 cm (7 1/2"), 16 mm
OR-635-02	19 cm (7 1/2"), 16 mm
OR-635-03	18.5 cm (7 1/4"), 12 mm
OR-635-04	18 cm (7"), 12 mm

Hoehn Periosteal Raspatory / Elevator

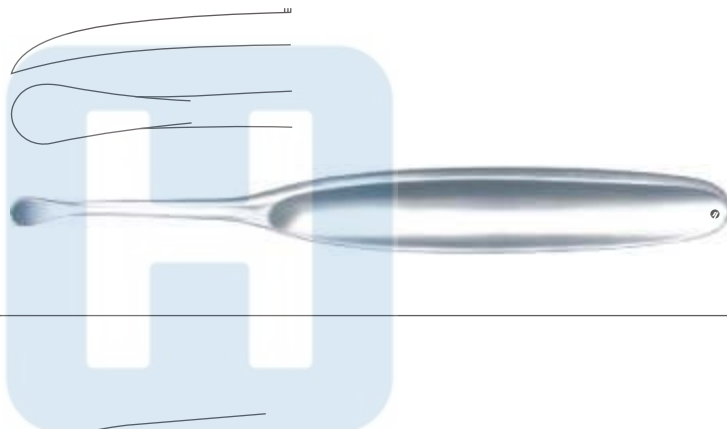

Catalog #	Size, Width
OR-637-01	16 cm (6 1/4"), 7 mm
OR-637-02	18.5 cm (7 1/4"), 15 mm
OR-637-03	19 cm (7 1/2"), 20 mm

Cushing Periosteal Raspatory / Elevator

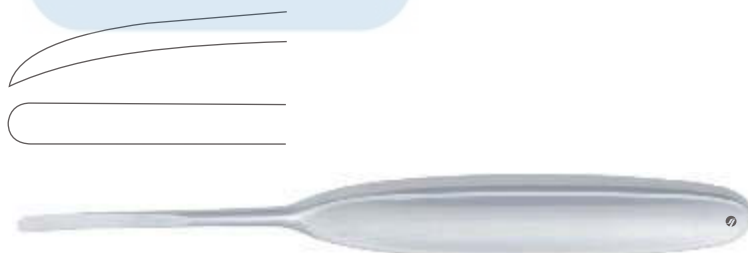

Catalog #	Size, Width
OR-639-01	17 cm (7"), 4 mm
OR-639-02	17.5 cm (7"), 5 mm
OR-639-03	19.5 cm (7 3/4"), 6 mm
OR-639-04	19.5 cm (7 3/4"), 7 mm

Martin-Cushing Periosteal Raspatory / Elevator



Catalog #	Size, Width
OR-640-17	17 cm (6 3/4"), 8 mm

Periosteal Elevators
 Raspatorien
 Periostótomos
 Rugines-raspatoires
 Periostotomi

Langenbeck Periosteal Raspatory / Elevator

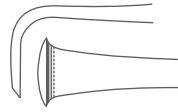

Catalog #	Size, Width
OR-641-18	18 cm (7"), 14 mm

Langenbeck Periosteal Raspatory / Elevator

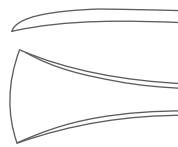

Catalog #	Size, Width
OR-643-19	19.5 cm (7 3/4"), 16 mm

Langenbeck Periosteal Raspatory / Elevator



Catalog #	Size, Width
OR-645-05	16 cm (6 1/4"), 5 mm
OR-645-06	16.5 cm (6 1/4"), 6 mm
OR-645-07	16.5 cm (6 1/4"), 7 mm

Farabeuf Periosteal Raspatory / Elevator



Catalog #	Size
OR-648-15	15 cm (6")

Farabeuf Periosteal Raspatory / Elevator



Catalog #	Size
OR-649-15	15 cm (6")

Periosteal Elevators
 Raspatorien
 Periostótomos
 Rugines-raspatóires
 Periostotomi

OR

BONE SURGERY

Sedillot Periosteal Raspatory / Elevator



Catalog #	Size
OR-651-21	22 cm (8 3/4")

FiberGrip™ Periosteal Raspatory / Elevator

FIBERGrip™

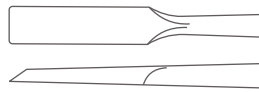

Catalog #	Size, Width
OR-654-19	19 cm (7 1/2"), 6mm

FiberGrip™ Periosteal Raspatory / Elevator

FIBERGrip™

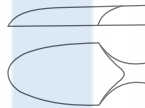

Catalog #	Size, Width
OR-655-20	20 cm (8"), 14 mm

FiberGrip™ Periosteal Raspatory / Elevator

FIBERGrip™

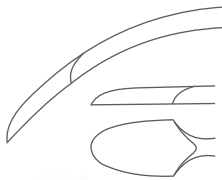

Catalog #	Size, Width
OR-657-20	19 cm (7 1/2"), 14 mm

FiberGrip™ Periosteal Raspatory / Elevator

FIBERGrip™

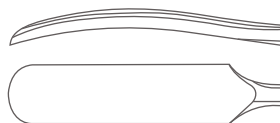

Catalog #	Size, Width
OR-659-18	18 cm (7"), 6 mm

Periosteal Elevators
 Raspatorien
 Periostótomos
 Rugines-raspatoires
 Periostotomi

FiberGrip™ Periosteal Raspatory / Elevator

FIBERGrip™

Catalog #	Size, Width
OR-661-18	18 cm (7"), 6 mm

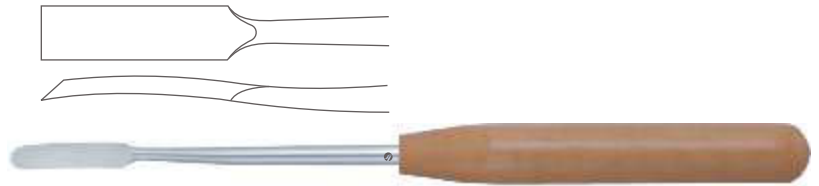

FiberGrip™ Periosteal Raspatory / Elevator

FIBERGrip™

Catalog #	Size, Width
OR-663-18	18 cm (7"), 3 mm

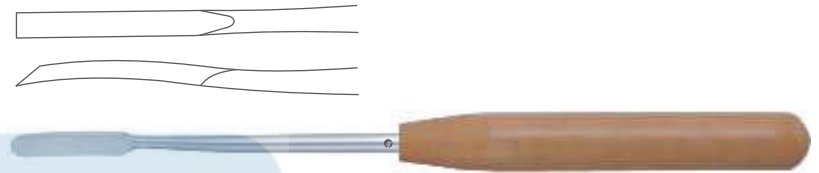

FiberGrip™ Periosteal Raspatory / Elevator

FIBERGrip™

Catalog #	Size, Width
OR-665-17	18.5 cm (7"), 13 mm



FiberGrip™ Periosteal Raspatory / Elevator

FIBERGrip™

Catalog #	Size, Width
OR-666-20	20 cm (8"), 19 mm



FiberGrip™ Periosteal Raspatory / Elevator

FIBERGrip™

Catalog #	Size, Width
OR-667-18	18 cm (7"), 13 mm



Periosteal Elevators
 Raspatorien
 Periostótomos
 Rugines-raspatoires
 Periostotomi

OR

BONE SURGERY

FiberGrip™ Periosteal Raspatory / Elevator

FIBERGrip™

Catalog #	Size, Width
OR-669-27	27.5 cm (10 3/4"), 20 mm



FiberGrip™ Wagner Periosteal Raspatory / Elevator

FIBERGrip™

Catalog #	Size, Width
OR-671-08	33 cm (13"), 8 mm
OR-671-17	33 cm (13"), 17 mm



Williger Periosteal Raspatory / Elevator

Catalog #	Size, Width
OR-673-13	12.5 cm (5"), 5 mm

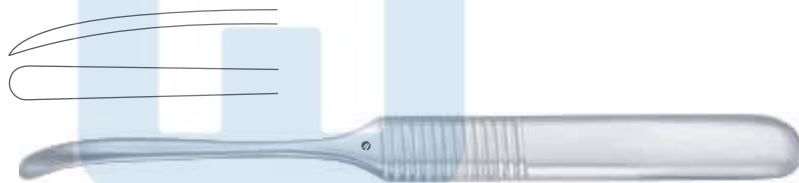

Kahre-Williger Periosteal Raspatory / Elevator

Catalog #	Size, Width
OR-675-01	16 cm (6 1/4"), 4 mm
OR-675-02	16 cm (6 1/4"), 5 mm



Williger Periosteal Raspatory / Elevator

Catalog #	Size, Width
OR-677-01	16 cm (6 1/4"), 7 mm
OR-677-02	16 cm (6 1/4"), 5 mm



Periosteal Elevators
 Raspatorien
 Periostótomos
 Rugines-raspatoires
 Periostotomi

Periosteal Raspatory / Elevator

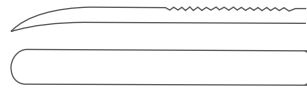

Catalog #	Size, Width
OR-679-06	17 cm (6 3/4"), 8 mm
OR-679-08	17 cm (6 3/4"), 6 mm



Doyen Rib Raspatory

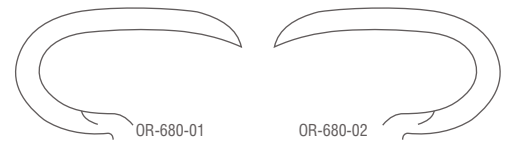

Catalog #	Size, Profile
OR-680-01	17.5 cm (7"), Curved Right
OR-680-02	17.5 cm (7"), Curved Left



**Doyen Rib Raspatory
 For Children**



Catalog #	Size, Profile
OR-681-01	17.5 cm (7"), Curved Right
OR-681-02	17.5 cm (7"), Curved Left



Alexander Periosteal Raspatory / Elevator



Catalog #	Size
OR-682-21	21 cm (8 1/4")

Periosteal Elevators
 Raspatorien
 Periostótomos
 Rugines-raspatoires
 Periostotomi

Semb Periosteal Raspatory / Elevator

Catalog #	Size, Width, Profile
OR-683-01	18.5 cm (7 ¼"), 12 mm, Fig. 1
OR-683-02	18.5 cm (7 ¼"), 12 mm, Fig. 2
OR-683-03	18.5 cm (7 ¼"), 13 mm, Fig. 3
OR-683-04	18.5 cm (7 ¼"), 13 mm, Fig. 4
OR-683-05	18.5 cm (7 ¼"), 15 mm, Fig. 5

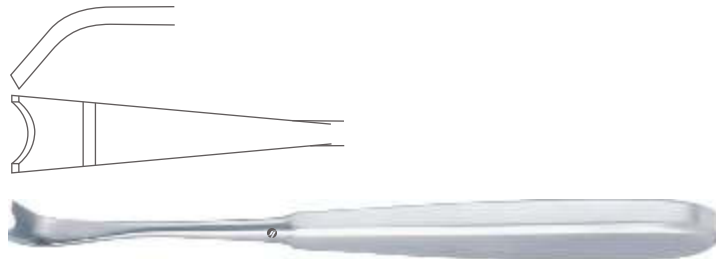

Lambotte Periosteal Raspatory / Elevator

Catalog #	Size, Width
OR-684-10	21.5 cm (8 ½"), 10 mm
OR-684-15	21.5 cm (8 ½"), 15 mm
OR-684-20	21.5 cm (8 ½"), 20 mm
OR-684-25	21.5 cm (8 ½"), 25 mm



Adson Periosteal Raspatory / Elevator

Catalog #	Size
OR-685-01	17 cm (6 ¾")
OR-685-02	17 cm (6 ¾")
OR-685-03	17.5 cm (7")
OR-685-04	17 cm (6 ¾")

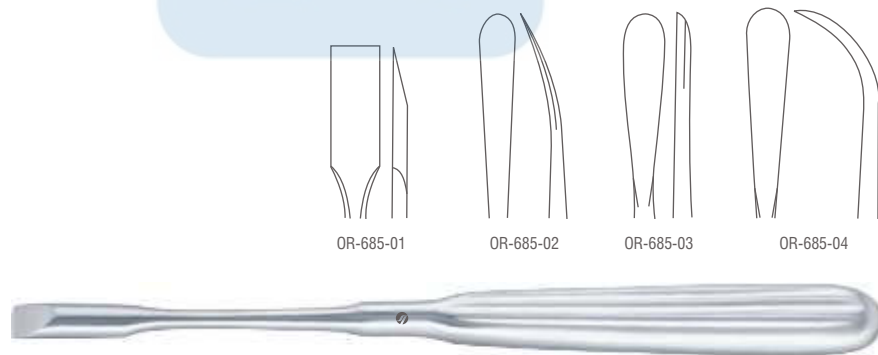

Cobb Periosteal Raspatory / Elevator

Catalog #	Size, Width
OR-687-10	28 cm (11"), 10 mm
OR-687-13	28 cm (11"), 13 mm
OR-687-19	28 cm (11"), 19 mm
OR-687-26	28 cm (11"), 26 mm
OR-687-32	28 cm (11"), 32 mm



Periosteal Elevators
 Raspatorien
 Periostótomos
 Rugines-raspatoires
 Periostotomi

Langenbeck Periosteal Elevator



Catalog #	Size, Blade Width
OR-691-20	19.5 cm (7 3/4"), 8 mm



Langenbeck Periosteal Elevator

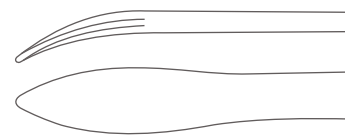

Catalog #	Size, Blade Width
OR-693-20	19.5 cm (7 3/4"), 10 mm



Martin-Langenbeck Periosteal Elevator



Catalog #	Size, Blade Width
OR-695-01	17 cm (6 3/4"), 5 mm
OR-695-02	17 cm (6 3/4"), 7 mm
OR-695-03	17 cm (6 3/4"), 8 mm
OR-695-04	19.5 cm (7 3/4"), 10 mm



Williger Periosteal Elevator



Catalog #	Size, Blade Width
OR-697-04	16 cm (6 1/4"), 4 mm
OR-697-07	17 cm (6 3/4"), 7 mm



Micro Elevator



Catalog #	Size
OR-699-16	16 cm (6 1/4")



Periosteal Elevators
 Raspatorien
 Periostótomos
 Rugines-raspatoires
 Periostotomi

OR

BONE SURGERY

Phalangeal Elevator

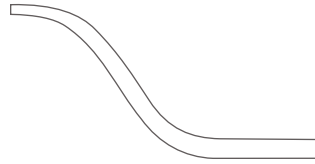

Catalog #	Size
OR-701-16	16 cm (6 1/4")

Alderdyce Periosteal Elevator Double Ended



Catalog #	Size
OR-703-21	21 cm (8 1/4")

McDonald Periosteal Elevator Double Ended

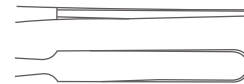
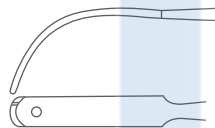

Catalog #	Size
OR-705-19	18.5 cm (7 1/4")

Watson-Cheyne Periosteal Elevator



Catalog #	Size
OR-707-13	13 cm (5 1/4")
OR-707-19	19 cm (7 1/2")

Swedish Periosteal Elevator



Catalog #	Size
OR-709-18	18 cm (7")
OR-709-20	20 cm (8")

Periosteal Elevators
 Raspatorien
 Periostótomos
 Rugines-raspatoires
 Periostotomi

Pennybaker Periosteal Elevator



Catalog #	Size
OR-711-23	23 cm (9")

O'Connell Periosteal Elevator



Catalog #	Size
OR-713-22	22 cm (9")

Toennis Periosteal Elevator



Catalog #	Size
OR-715-24	24 cm (9 1/2")

Bone Lever



Catalog #	Size
OR-721-06	16 cm (6 1/4")

Mini-Hohmann Bone Lever

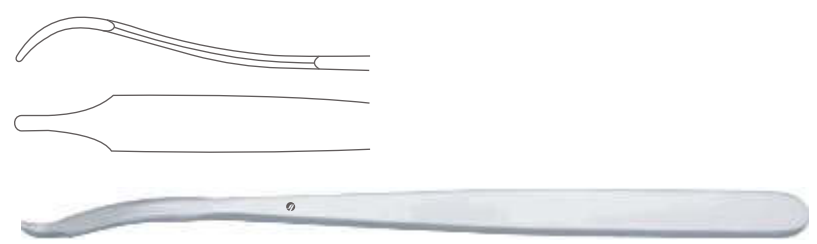

Catalog #	Size, Blade Width
OR-723-06	16 cm (6 1/4"), 6 mm
OR-723-08	16 cm (6 1/4"), 8 mm

Bone Levers
Knochenhebel
Elevadores para hueso
Leviers à os
Elevatori per ossa

OR

BONE SURGERY

Bone Lever

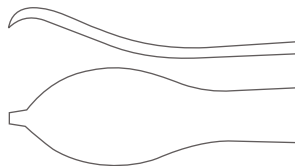

Catalog #	Size, Blade Width
OR-725-15	16 cm (6 1/4"), 15 mm



Bone Lever

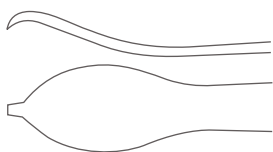

Catalog #	Size, Blade Width
OR-727-16	12 cm (4 3/4"), 15 mm



Wagner Bone Lever

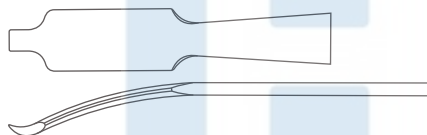

Catalog #	Size
OR-729-22	22 cm (8 3/4")



Bone Lever

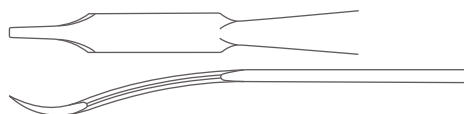

Catalog #	Size
OR-731-22	22 cm (8 3/4")



**Hohmann Bone Lever
Narrow Tip**



Catalog #	Size, Blade Width
OR-733-08	22 cm (8 3/4"), 8 mm



Bone Levers
Knochenhebel
Elevadores para hueso
Leviers à os
Elevatori per ossa

Hohmann Bone Lever
Narrow Tip



Catalog #	Size, Blade Width
OR-733-18	23.5 cm (9 1/2"), 18 mm

Hohmann Bone Lever
Narrow Tip



Catalog #	Size, Blade Width
OR-733-43	23.5 cm (9 1/2"), 43 mm

Hohmann Bone Lever
Narrow Tip



Catalog #	Size, Blade Width
OR-733-70	25 cm (9 3/4"), 70 mm

Hohmann Bone Lever
Narrow Tip



Catalog #	Size, Blade Width
OR-735-43	23.5 cm (9 1/4"), 43 mm

Hohmann Bone Lever
Wide Tip



Catalog #	Size, Blade Width
OR-737-22	25.5 cm (10"), 22 mm

Bone Levers
Knochenhebel
Elevadores para hueso
Leviers à os
Elevatori per ossa

Hohmann Bone Lever
Wide Tip



Catalog #	Size, Blade Width
OR-737-35	29 cm (11 1/2"), 35 mm

Hohmann Bone Lever
Wide Round Tip



Catalog #	Size, Blade Width
OR-739-24	27.5 cm (10 3/4"), 24 mm

Lange-Hohmann Bone Lever
Wide Tip With groove



Catalog #	Size, Blade Width
OR-741-22	25.5 cm (9 3/4"), 22 mm

Lange-Hohmann Modif Bone Lever

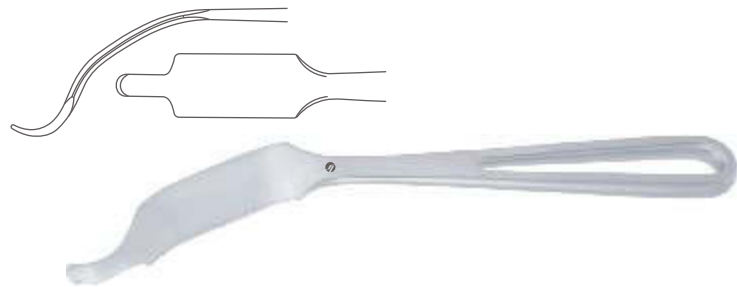

Catalog #	Size, Blade Width
OR-743-30	26.5 cm (10 1/2"), 30 mm

Lange-Hohmann Modif Bone Lever

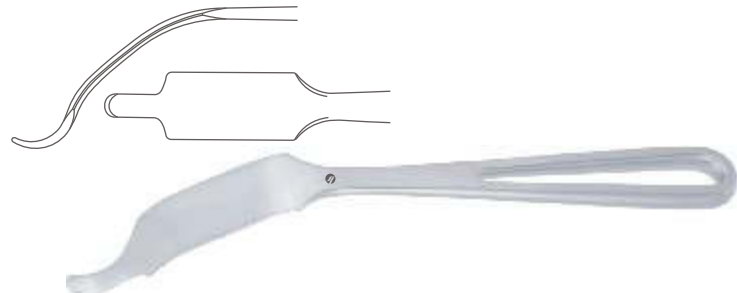

Catalog #	Size, Blade Width
OR-743-33	29 cm (11 1/2"), 33 mm

Bone Levers
Knochenhebel
Elevadores para hueso
Leviers à os
Elevatori per ossa

Verbrugge-Mueller Bone Lever



Catalog #	Size, Blade Width
OR-745-44	24 cm (9 1/2"), 44 mm

Verbrugge-Mueller Bone Lever

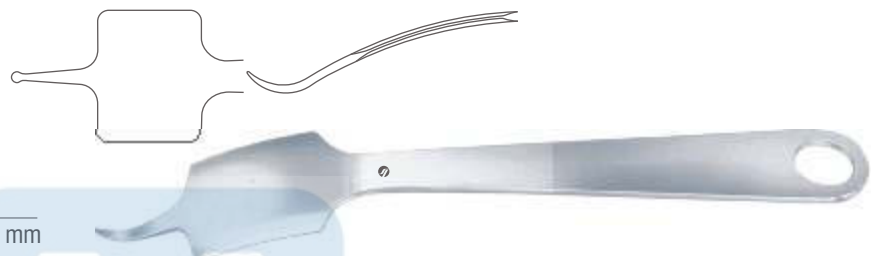

Catalog #	Size, Blade Width
OR-745-65	25.5 cm (10"), 65 mm

Bone Lever

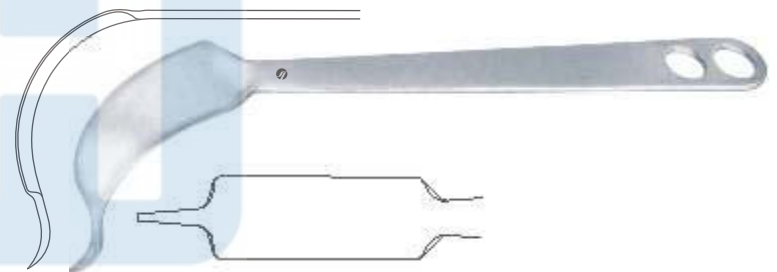

Catalog #	Size, Blade Width
OR-749-40	29 cm (11 1/2"), 40 mm

Bone Lever



Catalog #	Size, Blade Width
OR-751-22	30 cm (12"), 22 mm

Hohmann-Aldinger Bone Lever



Catalog #	Size, Blade Width
OR-753-24	27 cm (10 3/4"), 24 mm

Bone Levers
Knochenhebel
Elevadores para hueso
Leviers à os
Elevatori per ossa

OR

BONE SURGERY

Schumacher (Wagner) Bone Lever
Toothed Edge



Catalog #	Size, Blade Size
OR-755-37	34.5 cm (13 1/2"), 37 mm, 18 mm

Schumacher Bone Lever

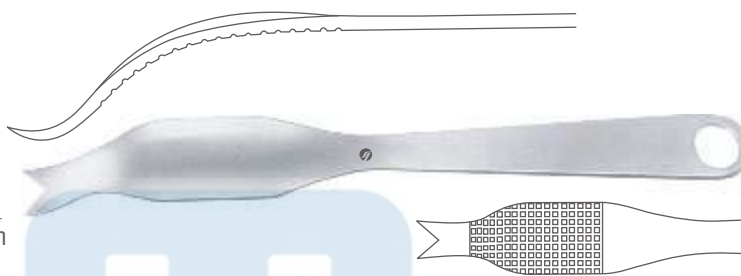

Catalog #	Size, Blade Size
OR-757-35	29 cm (11 1/2"), 35 mm, 18 mm

Watson-Jones Bone Lever



Catalog #	Size
OR-759-28	28 cm (11")

Bennett Bone Lever



Catalog #	Size, Blade Width
OR-761-43	24 cm (9 1/2"), 43 mm
OR-761-60	23.5 cm (9 1/4"), 60 mm

Murphy-Lane Bone Lever



Catalog #	Size, Blade Width
OR-763-30	32 cm (12 1/2"), 30 mm

Bone Levers, Knee Retractors, Spinal Retractors
 Knochenhebel, Kniehaken, Spinalhaken
 Elevadores para hueso, Separadores para rodilla, Separadores espinales
 Leviers à os, Ecarteurs pour le genou, Ecarteurs spinaux
 Elevatori per ossa, Divaricatori per il ginocchio, Divaricatori spinali

Lane-Terthowan Bone Lever



Catalog #	Size
OR-765-21	21.5 cm (8 1/2")

Lane Bone Lever

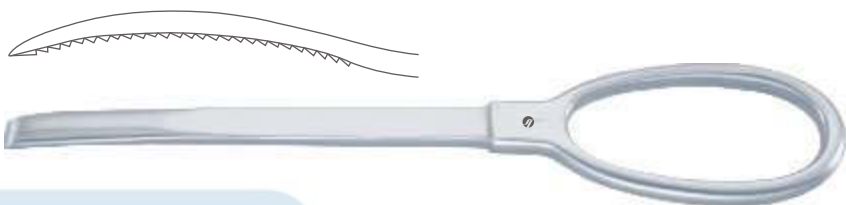

Catalog #	Size
OR-765-25	25.5 cm (10")

Bristow Bone Lever

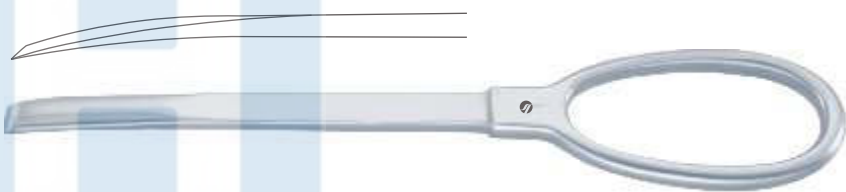

Catalog #	Size
OR-765-23	23 cm (9")

Chandler Bone Lever

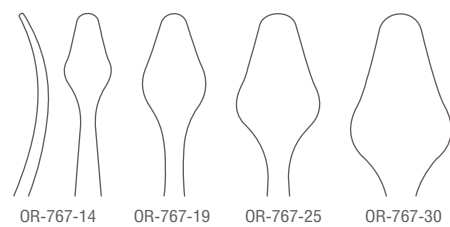

Catalog #	Size, Blade Width
OR-767-14	18 cm (7"), 14 mm
OR-767-19	20 cm (8"), 19 mm
OR-767-25	23 cm (9"), 25 mm
OR-767-30	25 cm (9 3/4"), 30 mm



Smillie Knee Retractor

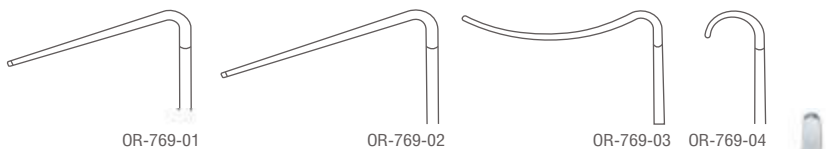

Catalog #	Size, Blade Size
OR-769-01	14 cm (5 1/2"), 32 x 19 mm
OR-769-02	14 cm (5 1/2"), 48 x 19 mm
OR-769-03	14 cm (5 1/2"), 57 x 19 mm
OR-769-04	14 cm (5 1/2"), 52 x 13 mm
OR-769-05	14 cm (5 1/2"), 12 x 13 mm



Knee Retractors, Spinal Retractors
 Kniehaken, Spinalhaken
 Separadores para rodilla, Separadores espinales
 Ecarteurs pour le genou, Ecarteurs spinaux
 Divaricatori per il ginocchio, Divaricatori spinali

Blount Knee Retractor
 Blunt



Catalog #	Size
OR-771-26	26.5 cm (10 1/2")

Blount Knee Retractor



Catalog #	Size
OR-773-26	26.5 cm (10 1/2")

Blount Knee Retractor



Catalog #	Size
OR-775-17	17.5 cm (7")

Taylor Knee Retractor



Catalog #	Size, Blade Size
OR-777-16	16 cm (6 1/4"), 75 x 30 mm

Taylor Knee Retractor



Catalog #	Size, Blade Size
OR-779-16	16cm (6 1/4"), 100 x 30 mm

Meniscus Knives
 Meniskotome, Meniskusmesser
 Cuchillos para menisco
 Bistouris à ménisque
 Meniscotomi

Hibbs Knee Retractor

Catalog #	Size, Blade Size
OR-781-13	23.5 cm (9 1/4"), 13 x 25 mm
OR-781-20	23.5 cm (9 1/4"), 20 x 50 mm
OR-781-25	23.5 cm (9 1/4"), 25 x 75 mm

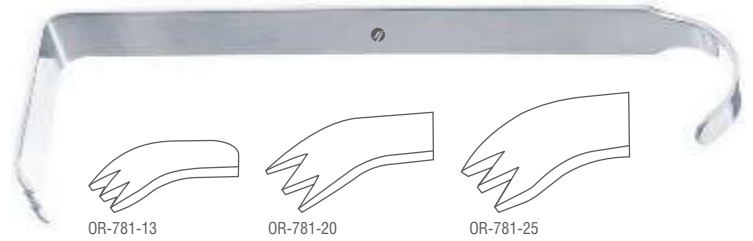

Smillie Meniscus Knife

Catalog #	Size
OR-790-17	17.5 cm (7")

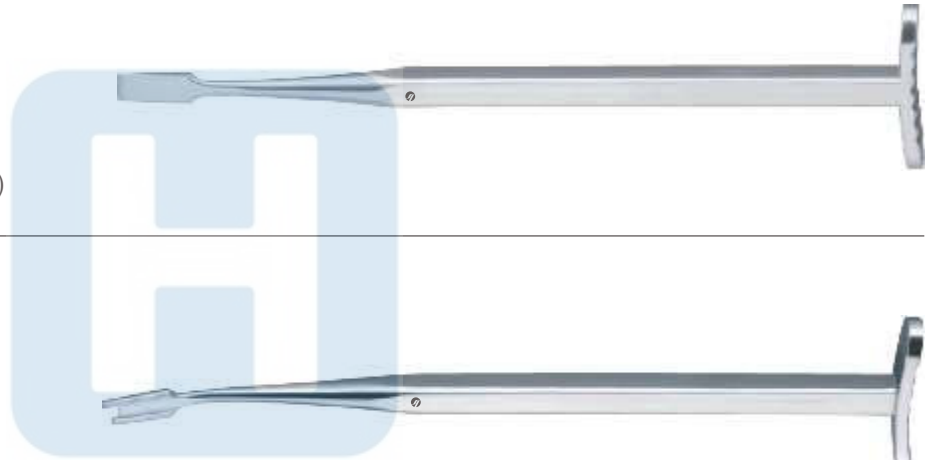

**Smillie Meniscus Knife
 Left**

Catalog #	Size
OR-791-17	17.5 cm (7")

**Smillie Meniscus Knife
 Right**

Catalog #	Size
OR-793-17	17.5 cm (7")

Meniscus Knife

Catalog #	Size
OR-795-18	18 cm (7")



Meniscus Knives, Tendon Strippers
 Meniskotome, Meniskussmesser, Sehnenstripper
 Cuchillos para menisco, Enucleadores de tendones
 Bistouris à ménisque, Instruments à écorcher les tendons
 Meniscotomi, Scollatendini

Neff Meniscus Knife
 Fig. 1



Catalog #	Size
OR-797-22	22 cm (8 3/4")

Neff Meniscus Knife
 Fig. 2



Catalog #	Size
OR-799-22	22 cm (8 3/4")

Selenius Meniscus Knife
 Fig. 1



Catalog #	Size
OR-801-22	21 cm (8 1/4")

Selenius Meniscus Knife
 Fig. 2



Catalog #	Size
OR-803-22	21 cm (8 1/4")

Bunnell Tendon Stripper

Catalog #	Size, Profile
OR-810-01	15 cm (6"), Fig. 1
OR-810-02	15 cm (6"), Fig. 2
OR-810-03	15 cm (6"), Fig. 3
OR-810-04	15 cm (6"), Fig. 4
OR-810-05	15 cm (6"), Fig. 5



Tendon Strippers
 Sehnenstripper
 Enucleadores de tendones
 Instruments à écorcher les tendons
 Scollatendini

Tendon Stripper
 Flexible Shaft



Catalog #	Size, Diameter
OR-812-40	23 cm (9"), 4.0 mm
OR-812-45	23 cm (9"), 4.5 mm
OR-812-55	23 cm (9"), 5.5 mm

Tendon Passing Instruments



Catalog #	Size
OR-814-00	33.5 cm (13 1/4")

Screw Only for Tendon Passing Instruments



Catalog #	Size
OR-814-90	31 cm (12 1/4")

Fischer Tendon Stripper
 Blunt



Catalog #	Size
OR-816-31	28.5 cm (11 1/4")

Tendon Stripper



Catalog #	Size
OR-818-29	23 cm (9")

Tendon Holding Forceps, Tendon Tunnelling Forceps
 Sehnenfasszangen, Sehnedurchzugzangen
 Pinzas para coger tendones, Pinzas para pasar tendones
 Pincas pour saisir les tendons, Pincas pour passer les tendons
 Pinze per afferrare tendini, Pinze passa-tendini

Bunnell Tendon Passer
 Malleable



Catalog #	Size
OR-820-23	16 cm (6 1/4")

Steinmann Tendon Holding Forcep



Catalog #	Size
OR-824-16	15 cm (6")

Brand Tendon Tunnelling Forcep
 1 x 2 Teeth



Catalog #	Size
OR-827-15	19 cm (7 1/2")
OR-827-19	24 cm (9 3/4")
OR-827-24	21 cm (8 1/4")

Tendon Tunnelling Forcep
 1 x 2 Teeth



Catalog #	Size
OR-828-21	21 cm (8 1/4")

Tendon Tunnelling Forcep
 1 x 2 Teeth



Catalog #	Size
OR-829-21	21 cm (8 1/4")

Tendon Holding Forceps, Tendon Interlacing Forceps
 Sehnenfasszangen, Sehneneinflechtzangen
 Pinzas para coger tendones, Pinzas para entrelazar tendones
 Pinces pour saisir les tendons, Pinces pour entrelacer les tendons
 Pinze per afferrare tendini, Pinze per allacciare tendini

Carroll Tendon Tunnelling Forcep



Catalog #	Size
OR-831-11	11.5 cm (4 1/2")

Tendon Holding Forcep



Catalog #	Size
OR-832-13	11.5 cm (4 1/2")

Kleinert-Kutz Tendon Holding Forcep

1 x 2 Teeth



Catalog #	Size
OR-834-20	21 cm (8 1/4")

Tendon Interlacing Forcep

Pointed



Catalog #	Size
OR-836-15	15.5 cm (6")

Tendon Interlacing Forcep

Pointed

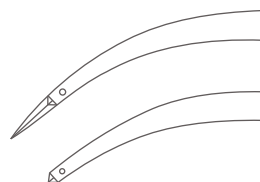

Catalog #	Size
OR-837-15	15 cm (6")

Reposition Forceps
 Repositionszangen
 Pinzas para reposición
 Pinces à réduction
 Pinze per riposizioni

Bone Repositioning Forcep
 Long Ratchet, Pointed

Catalog #	Size
OR-851-09	9 cm (3 1/2")
OR-851-14	15 cm (6")



Steinhauser Bone Repositioning Forcep

Catalog #	Size
OR-853-13	13 cm (5")



Reill Bone Repositioning Forcep

Catalog #	Size
OR-855-17	17 cm (6 3/4")

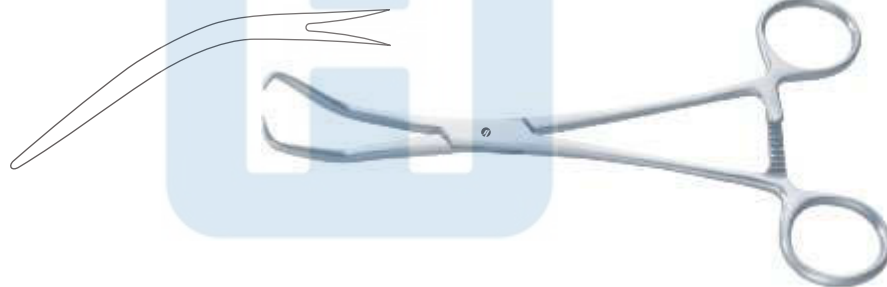

Bone Repositioning Forcep

Catalog #	Size
OR-857-20	20.5 cm (8")

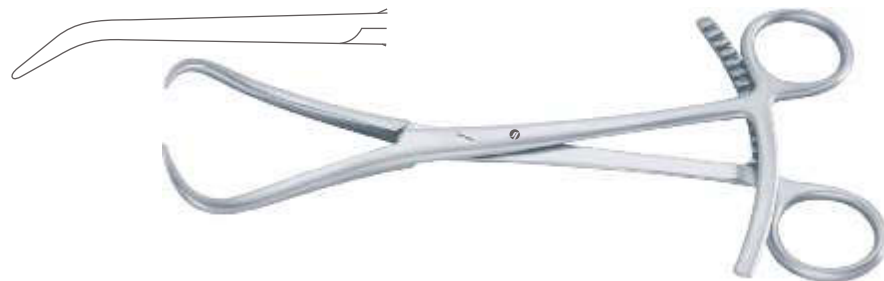

Bone Repositioning Forcep
 Long Ratchet, Pointed

Catalog #	Size
OR-859-12	13.5 cm (5 1/4")



Reposition Forceps, Bone Holding Forceps
 Repositionszangen, Knochenhaltezangen
 Pinzas para reposición, Pinzas para hueso
 Pinces à réduction, Daviers porte-os
 Pinze per riposizioni, Tenaglie per ossa

Lewin Bone Repositioning Forcep



Catalog #	Size
OR-862-17	18.5 cm (7 1/4")

**Bone Repositioning Forcep
 Delicate**



Catalog #	Size
OR-864-14	14 cm (5 1/2")

**Bone Repositioning Forcep / Patella Forceps
 Self, Centering**



Catalog #	Size
OR-866-18	18.5 cm (7 1/2")

Bone Repositioning Forcep / Malleolar Forceps



Catalog #	Size
OR-868-21	21 cm (8 1/4")

Bone Holding Forcep



Catalog #	Size
OR-869-14	14 cm (5 1/2")

Reposition Forceps, Bone Holding Forceps
 Repositionszangen, Knochenhaltezangen
 Pinzas para reposición, Pinzas para hueso
 Pinces à réduction, Daviers porte-os
 Pinze per riposizioni, Tenaglie per ossa

Bone Repositioning Forcep
 With Tread Fixation

Catalog #	Size
OR-871-16	17 cm (6 ¾")
OR-871-24	24 cm (9 ½")



Langenbeck Bone Holding Forcep

Catalog #	Size
OR-874-21	21 cm (8 ¼")



Fergusson Bone Holding Forcep
 Heavy Pattern

Catalog #	Size
OR-876-21	21 cm (8 ¼")



Bone Holding Forcep
 Heavy Pattern

Catalog #	Size
OR-878-20	20 cm (8")



Bone Holding Forcep / Sequestrum Forcep

Catalog #	Size, Profile
OR-880-20	20 cm (8"), Straight
OR-881-20	20 cm (8"), Curved



Reposition Forceps, Bone Holding Forceps
 Repositionszangen, Knochenhaltezangen
 Pinzas para reposición, Pinzas para hueso
 Pinces à réduction, Daviers porte-os
 Pinze per riposizioni, Tenaglie per ossa

Bircher-Ganske Cartilage Seizing Forcep

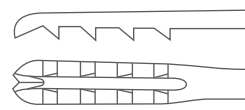

Catalog #	Size, Profile
OR-882-01	20.5 cm (8"), Straight
OR-882-02	20.5 cm (8"), Curved Upwards
OR-882-03	20 cm (8"), Curved Sideways

Salzer Bone Holding Forcep
 Curved Sideways

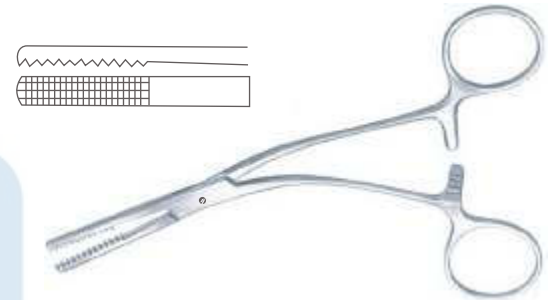
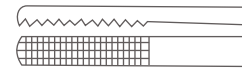

Catalog #	Size
OR-885-16	16 cm (6 1/4")

Van Buren Bone Holding Forcep



Catalog #	Size
OR-887-01	23 cm (9")

Semb Bone Holding Forcep

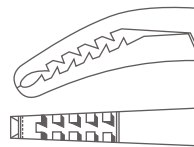

Catalog #	Size
OR-887-02	19 cm (7 1/2")

Dingmann Cartilage Seizing Forcep

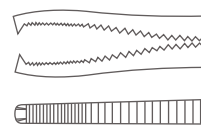

Catalog #	Size
OR-889-19	18.5 cm (7 1/4")

Bone Holding Forceps
Knochenhaltezangen
Pinzas para hueso
Daviers porte-os
Tenaglie per ossa

Martin Cartilage Seizing Forcep

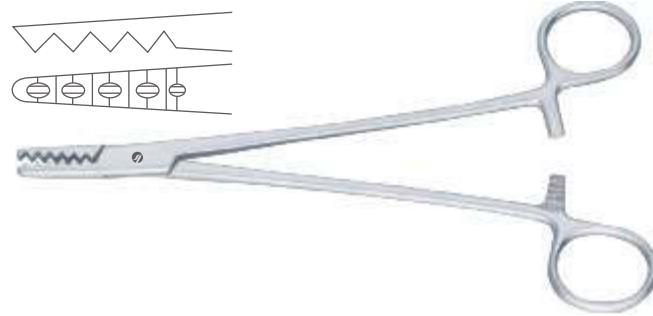

Catalog #	Size
OR-892-19	18.5 cm (7 1/4")

Frosch Bone Holding Forcep

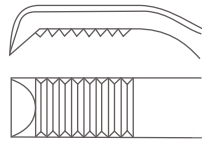

Catalog #	Size
OR-894-18	18 cm (7")

Kern Bone Holding Forcep

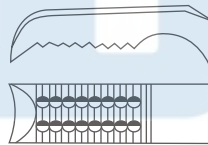
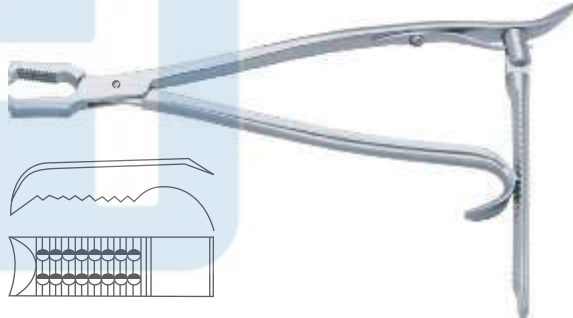

Catalog #	Size
OR-896-17	17 cm (6 3/4")
OR-896-21	21 cm (8 1/4")

Heygroves Bone Holding Forcep With Thread Fixations



Catalog #	Size
OR-899-21	21 cm (8 1/4")
OR-899-27	27 cm (10 3/4")
OR-899-30	30 cm (12")

Semb Bone Holding Forcep Curved Sideways, With Ratchet

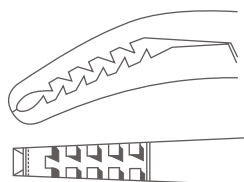

Catalog #	Size
OR-901-19	19 cm (7 1/2")

OR

BONE SURGERY

Bone Holding Forceps
Knochenhaltezangen
Pinzas para hueso
Daviers porte-os
Tenaglie per ossa

Farabeuf Bone Holding Forcep



Catalog #	Size
OR-904-23	23 cm (9")
OR-904-26	26 cm (10 1/4")

**Farabeuf Bone Holding Forcep
With Ratchet**



Catalog #	Size
OR-906-26	26 cm (10 1/4")

**Lambotte Bone Holding Forcep
Straight**



Catalog #	Size
OR-908-22	22 cm (8 3/4")

**Lambotte Bone Holding Forcep
Straight, One Jaw Moveable**



Catalog #	Size
OR-908-26	26 cm (10 1/4")
OR-908-33	33 cm (13")

**Ulrich Bone Holding Forcep
Straight, With Thread Fixation**

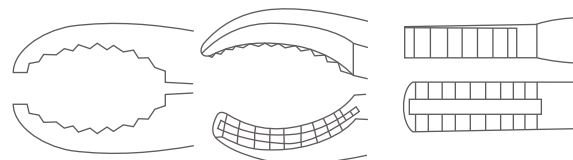

Catalog #	Size
OR-910-23	23 cm (9")
OR-910-25	25 cm (9 3/4")
OR-910-28	28 cm (11")



Bone Holding Forceps
Knochenhaltezangen
Pinzas para hueso
Daviers porte-os
Tenaglie per ossa

OR

BONE SURGERY

Ulrich Bone Holding Forcep
Curved, With Thread Fixation

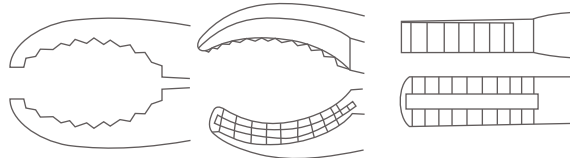

Catalog #	Size
OR-911-23	22 cm (8 3/4")
OR-911-25	24 cm (9 1/2")
OR-911-28	27 cm (10 3/4")



Bone Holding Forcep
Self Centering, With Thread Fixation

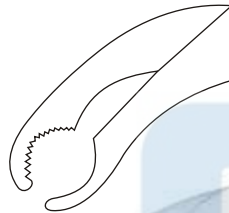

Catalog #	Size
OR-913-15	15 cm (6")
OR-913-19	19 cm (7 1/2")
OR-913-24	24 cm (9 1/2")
OR-913-26	26 cm (10 1/4")
OR-913-28	28 cm (11")



Lane Bone Holding Forcep
Without Ratchet

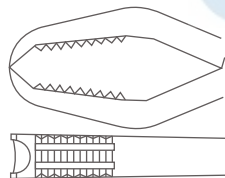

Catalog #	Size
OR-916-33	33 cm (13")



Lane Bone Holding Forcep
With Ratchet

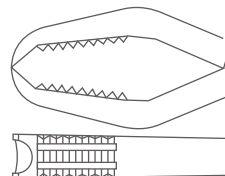

Catalog #	Size
OR-918-33	33 cm (13")

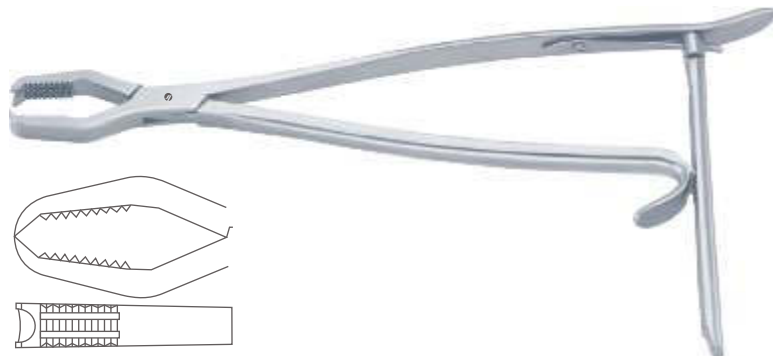

Bone Holding Forceps, Bone Rongeurs
 Knochenhaltezaugen, Hohlmeißelzaugen
 Pinzas para hueso, Pinzas gubias
 Daviers porte-os, Pincès-gouges
 Tenaglie per ossa, Pinze-sgorbie

Verbrugge Bone Holding Forcep

Catalog #	Size
OR-921-01	25 cm (9 3/4")
OR-921-02	26 cm (10 1/4")
OR-921-03	27 cm (10 3/4")



Verbrugge Bone Holding Forcep

Catalog #	Size
OR-923-01	17.5 cm (7")

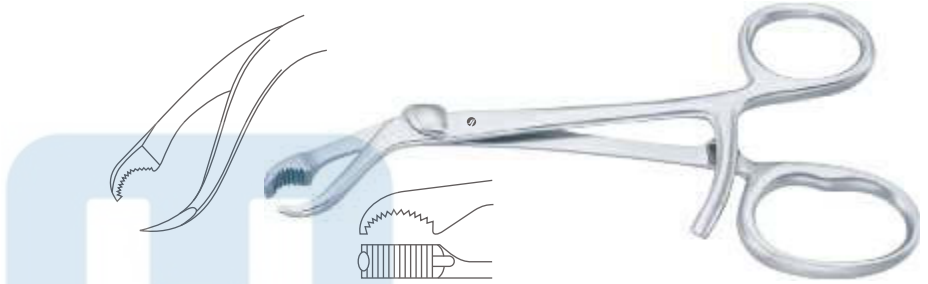

**Percy Amputation Shield
 Detachable**

Catalog #	Size
OR-925-00	Standard



Stellbrink Bone Rongeur

Catalog #	Size
OR-931-01	17.5 cm (7")
OR-931-02	16.5 cm (6 1/2")



Friedman Bone Rongeur

Catalog #	Size
OR-932-12	12.5 cm (5")



Bone Rongeurs
Hohlmeißelzangen
Pinzas gubias
Pinces-gouges
Pinze-sgorbie

Friedman Bone Rongeur

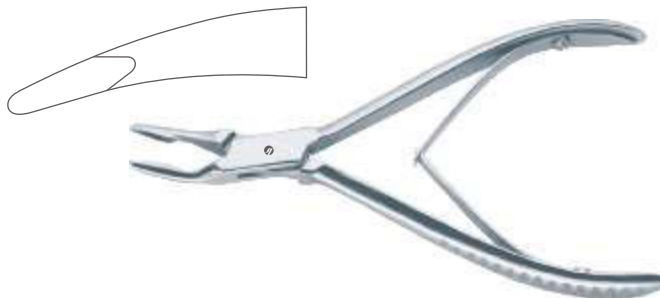

Catalog #	Size
OR-933-01	13.5 cm (5 1/4")

Friedman Bone Rongeur



Catalog #	Size
OR-934-02	13.5 cm (5 1/4")

Cleveland Bone Rongeur



Catalog #	Size
OR-935-01	13.5 cm (5 1/4")

Cleveland Bone Rongeur



Catalog #	Size
OR-935-02	16.5 cm (6 1/2")

Mead Bone Rongeur



Catalog #	Size
OR-937-16	16.5 cm (6 1/2")

Bone Rongeurs
Hohlmeißelzangen
Pinzas gubias
Pinces-gouges
Pinze-sgorbie

Hartmann Bone Rongeur



Catalog #	Size
OR-937-18	17.5 cm (7")

**Jansen Bone Rongeur
Straight**



Catalog #	Size
OR-938-18	18 cm (7")

**Jansen Bone Rongeur
Curved**



Catalog #	Size
OR-939-18	18 cm (7")

Lempert Bone Rongeur



Catalog #	Size
OR-940-19	19 cm (7 1/2")

Blumenthal Bone Rongeur



Catalog #	Size
OR-941-01	15 cm (6")



Bone Rongeurs
Hohlmeißelzangen
Pinzas gubias
Pinces-gouges
Pinze-sgorbie

OR

BONE SURGERY

Blumenthal Bone Rongeur

Catalog #	Size
OR-941-02	15 cm (6")



Blumenthal Bone Rongeur

Catalog #	Size
OR-941-03	14 cm (5 1/2")



Luer Bone Rongeur Straight

Catalog #	Size
OR-942-18	18.5 cm (7 1/4")

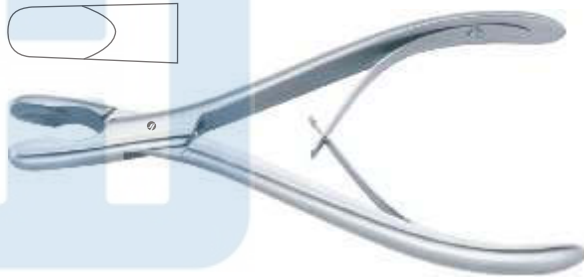

Luer Bone Rongeur Curved

Catalog #	Size
OR-943-18	18 cm (7")



Luer Bone Rongeur

Catalog #	Size
OR-945-01	14.5 cm (5 3/4")
OR-945-02	14.5 cm (5 3/4")
OR-945-03	14.5 cm (5 3/4")



Bone Rongeurs
Hohlmeißelzangen
Pinzas gubias
Pincas-gouges
Pinze-sgorbie

Bohler Bone Rongeur
Straight, Compound Action



Catalog #	Size
OR-946-15	15.5 cm (6")

Bohler Bone Rongeur
Curved, Compound Action



Catalog #	Size
OR-947-15	15.5 cm (6")

Beyer Bone Rongeur
Compound Action



Catalog #	Size
OR-949-18	18 cm (7")

Zaufal-Jansen Bone Rongeur
Compound Action



Catalog #	Size
OR-951-18	18 cm (7")

Mayfield Bone Rongeur
Compound Action



Catalog #	Size
OR-953-17	18 cm (7")

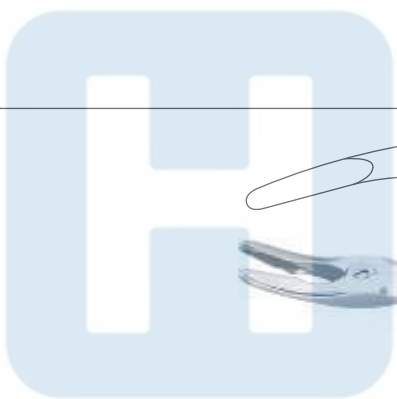

Bone Rongeurs
Hohlmeißelzangen
Pinzas gubias
Pinces-gouges
Pinze-sgorbie

OR

BONE SURGERY

Marquard Bone Rongeur
Compound Action



Catalog #	Size
OR-953-20	20.5 cm (8")

Ruskin Bone Rongeur
Compound Action



Catalog #	Size
OR-955-18	19 cm (7 1/2")

Ruskin Bone Rongeur
Compound Action



Catalog #	Size
OR-955-24	24 cm (9 1/2")

Semb Bone Rongeur
Compound Action



Catalog #	Size
OR-957-22	23.5 cm (9 1/4")

Stille Bone Rongeur
Compound Action



Catalog #	Size
OR-957-23	22.5 cm (8 3/4")

Bone Rongeurs
Hohlmeißelzangen
Pinzas gubias
Pincés-gouges
Pinze-sgorbie

Echlin Bone Rongeur
Compound Action

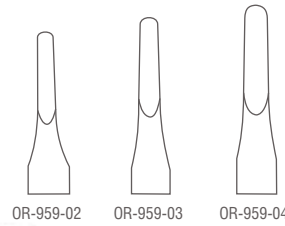

Catalog #	Size, Bite Size
OR-959-02	23 cm (9"), 2 x 10 mm
OR-959-03	23 cm (9"), 3 x 10 mm
OR-959-04	23 cm (9"), 4 x 10 mm

Stille-Ruskin Bone Rongeur
Compound Action



Catalog #	Size
OR-959-23	23.5 cm (9 1/4")

Roettgen-Ruskin Bone Rongeur
Compound Action



Catalog #	Size
OR-959-24	24.5 cm (9 3/4")

Leksell-Stille Bone Rongeur
Compound Action



Catalog #	Size
OR-961-01	24.5 cm (9 3/4")

Leksell-Stille Bone Rongeur
Compound Action



Catalog #	Size
OR-961-02	24.5 cm (9 3/4")

Bone Rongeurs
Hohlmeißelzangen
Pinzas gubias
Pinces-gouges
Pinze-sgorbie

Frykholm Bone Rongeur
Compound Action



Catalog #	Size
OR-963-24	24.5 cm (9 3/4")

Stille-Luer Bone Rongeur
Straight, Compound Action



Catalog #	Size
OR-964-22	22.5 cm (8 3/4")

Stille-Luer Bone Rongeur
Curved, Compound Action



Catalog #	Size
OR-965-22	22.5 cm (8 3/4")

Stille-Luer Bone Rongeur
Straight, Compound Action



Catalog #	Size
OR-966-23	23 cm (9")
OR-966-27	26.5 cm (10 1/2")

Stille-Luer Bone Rongeur
Curved, Compound Action



Catalog #	Size
OR-967-23	23 cm (9")
OR-967-27	26.5 cm (10 1/2")

OR

BONE SURGERY

Bone Rongeurs, Bone Cutting Forceps
 Hohlmeißelzangen, Knochensplitterzangen
 Pinzas gubias, Pinzas cortantes para hueso
 Pincers-gouges, Pincers coupantes à os
 Pinze-sgorbie, Cesioie per ossa

Sauerbruch Bone Rongeur
 Compound Action

Catalog #	Size
OR-968-01	31 cm (12 1/4")
OR-968-02	31 cm (12 1/4")

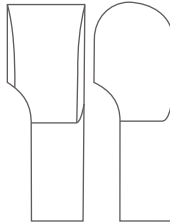

Cottle-Kazanjian Bone Cutting Forcep

Catalog #	Size
OR-970-19	18.5 cm (7 1/4")



Liston Bone Cutting Forcep
 Straight

Catalog #	Size
OR-972-14	14 cm (5 1/2")
OR-972-17	17 cm (6 3/4")
OR-972-19	20 cm (8")
OR-972-22	22 cm (8 3/4")

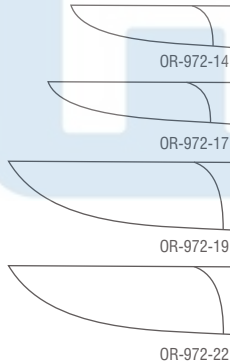

Liston Bone Cutting Forcep
 Curved

Catalog #	Size
OR-973-14	14 cm (5 1/2")
OR-973-17	17 cm (6 3/4")
OR-973-19	20 cm (8")
OR-973-22	22 cm (8 3/4")

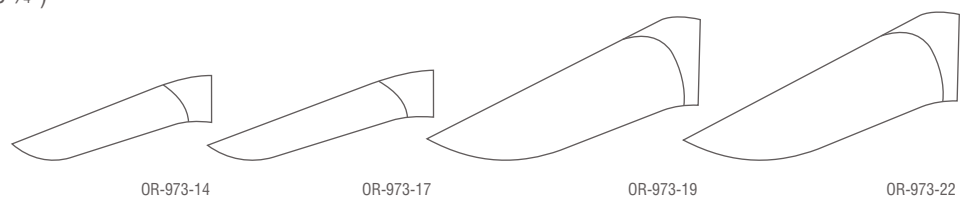

OR-973-14 OR-973-17 OR-973-19 OR-973-22

Bone Cutting Forceps
Knochensplitterzangen
Pinzas cortantes para hueso
Pinces coupantes à os
Cesoie per ossa

OR

BONE SURGERY

Cleveland Bone Cutting Forcep



Catalog #	Size
OR-975-15	14.5 cm (5 3/4")
OR-975-17	17 cm (6 3/4")

Bohler Bone Cutting Forcep Compound Action, Light



Catalog #	Size
OR-976-15	14.5 cm (5 3/4")

Bohler Bone Cutting Forcep Compound Action, Heavy



Catalog #	Size
OR-977-15	14.5 cm (5 3/4")

Cleveland Bone Cutting Forcep



Catalog #	Size
OR-979-15	16 cm (6 1/4")

Ruskin-Liston Bone Cutting Forcep Straight, Compound Action



Catalog #	Size
OR-980-18	18 cm (7")

Bone Cutting Forceps
 Knochensplitterzangen
 Pinzas cortantes para hueso
 Pincas coupantes à os
 Cesoie per ossa

Ruskin-Liston Bone Cutting Forcep
 Curved, Compound Action



Catalog #	Size
OR-981-18	18 cm (7")

Stille-Liston Bone Cutting Forcep



OR-982-01



OR-982-02



OR-982-03

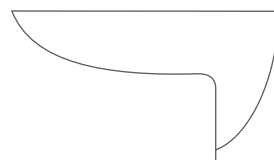

OR-983-04



Catalog #	Size, Profile
OR-982-01	27.5 cm (10 3/4"), Straight, Compound Action
OR-982-02	23.5 cm (9 1/4"), Curved Compound Action
OR-982-03	27.5 cm (10 3/4"), Curved Compound Action
OR-983-04	26 cm (10 1/4"), Compound Action

Liston-Key Bone Cutting Forcep
 Compound Action

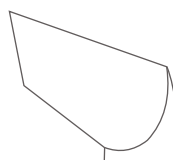

Catalog #	Size
OR-985-27	25.5 cm (10")

Hand Restrainer, Tourniquet
Handhalter, Kompressorium
Sujetador de mano, Compresor
Reteneur pour main, Compresseur
Fissatore per mano, compressorio

Semb Bone Cutting Forcep
Compound Action



Catalog #	Size
OR-987-25	24.5 cm (9 3/4")

Hand Immobilizer
Aluminium

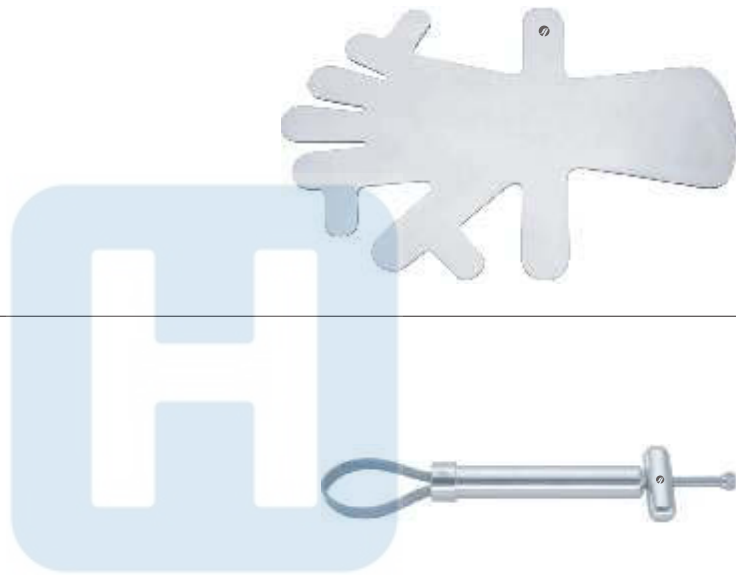

Catalog #	Profile
OR-988-01	For Children
OR-988-02	For Adults

Feldheim Tourniquet



Catalog #	Size
OR-990-10	10 cm (4")

Ideal Finger Nail Drill Complete
With Drill Ref: OR-992-01 to OR-992-03



Catalog #	Size
OR-992-00	Standard

Spare Drill



Catalog #	Profile
OR-992-01	Small
OR-992-02	Medium
OR-992-03	Large

Finger Ring Saws, Finger Nail Drill
 Fingerringsägen, Fingernagelbohrer
 Sierras para abrir anillos, Dedo clavo perforación
 Scies pour couper les bagues, Foret d'angle de doigt
 Seghe per anelli, Dito trivello del chiodo

Martin Finger Ring Saw



Catalog #	Size
OR-994-17	18.5 cm (7 1/4")

Spare Saw Blade



Catalog #	Size
OR-994-90	Standard

Walton Finger Ring Saw

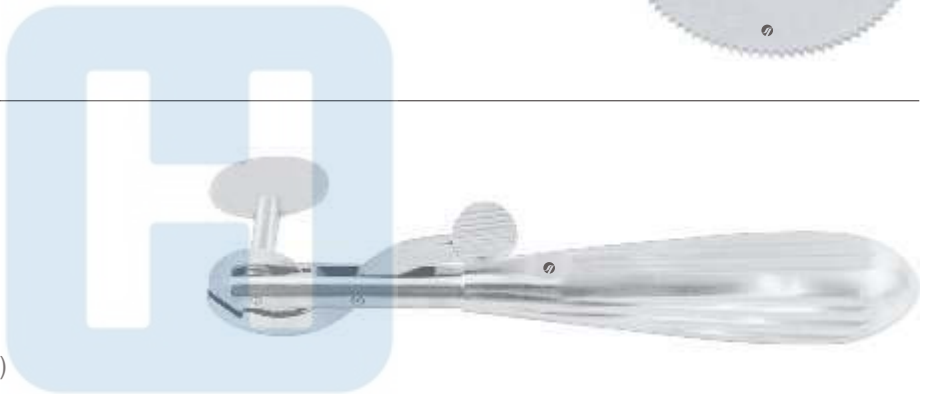

Catalog #	Size
OR-995-16	16 cm (6 1/4")

Spare Saw Blade



Catalog #	Size
OR-995-01	Standard

Finger Ring Saw



Catalog #	Size
OR-996-17	17 cm (6 3/4")

Nail Extracting Forceps
 Nagelextraktionszangen
 Pinzas para arrancar uñas
 Pinces pour extraire les ongles
 Pinze per la lacerazione delle unghie

Spare Saw Blade

Catalog #	Size
OR-996-10	N/A



Anvil Nail Extracting Forcep

Catalog #	Size
OR-998-12	12.5 cm (5")

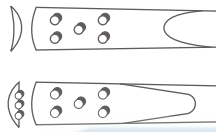

Radolf Nail Extracting Forcep

Catalog #	Size
OR-999-13	14 cm (5 1/2")

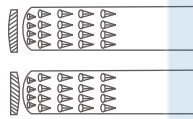

HOSPITA®

ALWAYS THE BEST

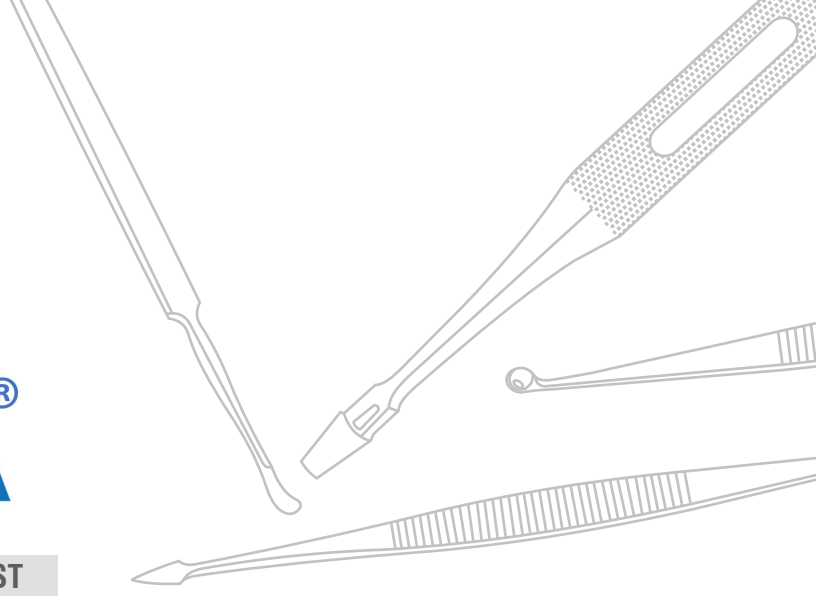

DM



DERMATOLOGY

A dermatology practice requires an instrument provider that is fast, reliable and manufactures products of premium quality. This is precisely why dermatologists recommend our dermatology instruments to their colleagues without hesitation. At Hospita Instruments we specialize in scissors, curettes and punches most often used by dermatologists.



Dermatologie

Dermatología

Dermatologie

Dermatologia

Milium Knife, Lupus Instruments
 Milienmesser, Lupusinstrumente
 Chuchillo para milium, Instrumentos para lupus
 Couteau pour milium, Instruments pour les lupus
 Bisturi per milie, Strumenti per lupus

Monocorps Milium Knife



Catalog #	Size
DM-100-14	14 cm (5 1/2")

Vidal Lupus Scraper



Catalog #	Size
DM-111-14	13 cm (5")

Fox Lupus Curette



Catalog #	Size, Profile
DM-200-01	14 cm (5 1/2"), Fig. 1
DM-200-02	14 cm (5 1/2"), Fig. 2
DM-200-03	14 cm (5 1/2"), Fig. 3
DM-200-04	14 cm (5 1/2"), Fig. 4



Wolff Lupus Curette



Catalog #	Size, Profile
DM-220-01	14 cm (5 1/2"), Fig. 1
DM-220-02	14 cm (5 1/2"), Fig. 2
DM-220-03	14 cm (5 1/2"), Fig. 3
DM-220-04	14 cm (5 1/2"), Fig. 4
DM-220-05	14 cm (5 1/2"), Fig. 5
DM-220-06	14 cm (5 1/2"), Fig. 6

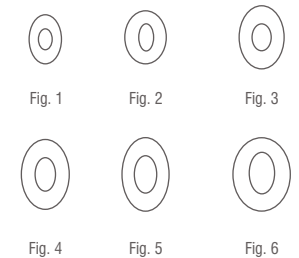

Dermal Punches
Hauttrephine
Trépanos para piel
Trépanos cutanés
Trefine cutanee

Kaye Face-Lift Hook



Catalog #	Size, Profile
DM-225-04	13 cm (5"), 4 Prongs
DM-225-05	13 cm (5"), 5 Prongs

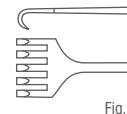
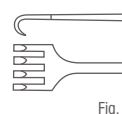

Dermal Punch Sharp



Catalog #	Size, Diameter
DM-300-00	8 cm (3 1/4"), Handle Only
DM-300-02	5.5 cm (2 1/4"), 2.0 mm Ø
DM-300-04	5.5 cm (2 1/4"), 4.0 mm Ø
DM-300-06	5.5 cm (2 1/4"), 6.0 mm Ø
DM-300-08	5.5 cm (2 1/4"), 8.0 mm Ø
DM-300-10	5.5 cm (2 1/4"), 10.0 mm Ø
DM-300-12	5.5 cm (2 1/4"), 12.0 mm Ø



Keyes Dermal Punch Sharp



Catalog #	Size, Diameter
DM-320-02	11 cm (4 1/2"), 2.0 mm Ø
DM-320-03	11 cm (4 1/2"), 3.0 mm Ø
DM-320-04	11 cm (4 1/2"), 4.0 mm Ø
DM-320-05	11 cm (4 1/2"), 5.0 mm Ø
DM-320-06	11 cm (4 1/2"), 6.0 mm Ø
DM-320-07	11 cm (4 1/2"), 7.0 mm Ø
DM-320-08	11 cm (4 1/2"), 8.0 mm Ø

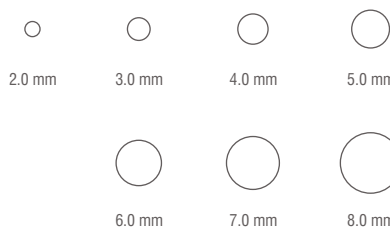

Unna Comedone Extractor



Catalog #	Size
DM-351-14	14.5 cm (5 3/4")



Comedone Extractors
 Komedoneninstrumente
 Extractores para comedones
 Tire-comédons
 Tiracomedoni

Unna Comedone Extractor



Catalog #	Size
DM-353-14	14.5 cm (5 3/4")

Saalfeld Comedone Extractor



Catalog #	Size
DM-361-10	11 cm (4 1/2")

Saalfeld Comedone Extractor



Catalog #	Size
DM-365-14	14.5 cm (5 3/4")

Schamberg Comedone Extractor



Catalog #	Size
DM-371-10	9.5 cm (3 3/4")

Katsch Comedone Extractor



Catalog #	Size
DM-381-14	16 cm (6 1/4")

Comedone Extractors
Komedoneninstrumente
Extractores para comedones
Tire-comédons
Tiracomedoni

Unna-Vidal Comedone Extractor

Catalog #	Size
DM-390-11	11.5 cm (4 ½")

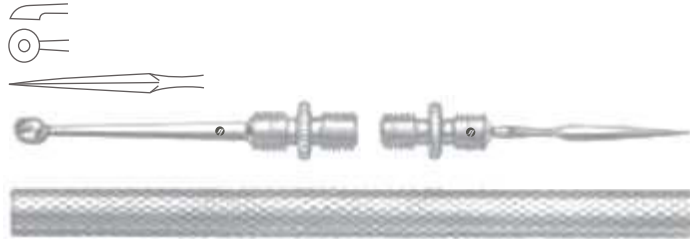

HOSPITA®

ALWAYS THE BEST

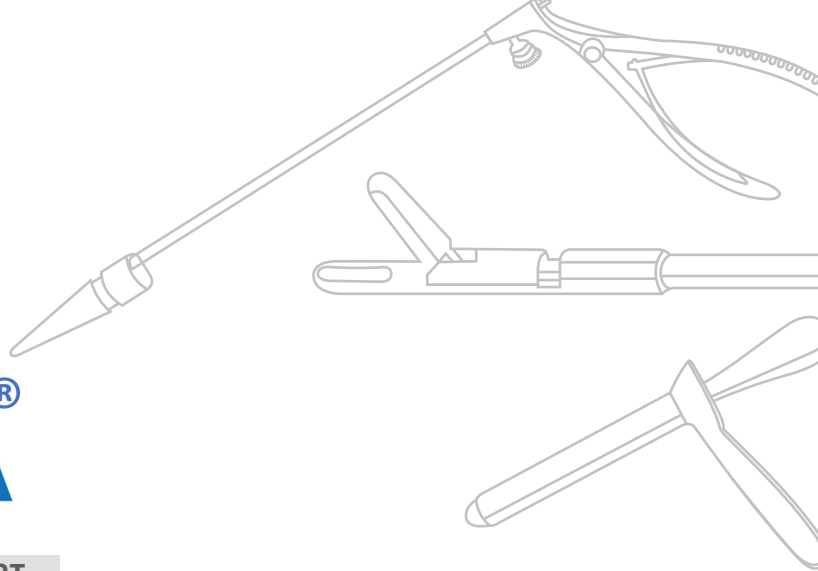

SI

STOMACH, INTESTINES,
RECTUM

Hospita manufactures a broad range of instruments for specialist field of stomach, intestine and rectum surgery. Our range includes but is not limited to the following intestinal and tissue grasping forceps, intestinal clamps, rectal specula, rectal spreaders, .anuscope, proctoscopes, rectoscopes, hemorrhoidal ligator & rectal biopsy forceps



Magen, Darm, Rektum

Estómago, Intestinos, Recto

Estomac, Intestins, Rectum

Stomaco, Intestini, Retto

Intestinal and Tissue Grasping Forceps
 Darm- und Gewebefasszangen
 Pinzas para intestinos y tejidos
 Pinces pour saisir intestins et tissus
 Pinze per afferrare intestino e tessuti

Allis-Baby Intestinal and Tissue Grasping Forcep
 4 x 5 Teeth

Catalog #	Size
SI-010-12	13 cm (5")



Allis Intestinal and Tissue Grasping Forcep
 4 x 5 Teeth

Catalog #	Size
SI-012-15	15.5 cm (6")



Allis Intestinal and Tissue Grasping Forcep
 5 x 6 Teeth

Catalog #	Size
SI-015-15	15.5 cm (6")
SI-015-19	19 cm (7 1/2")
SI-015-25	25.5 cm (10")



Allis Atrauma Intestinal and Tissue Grasping Forcep

Catalog #	Size
SI-020-16	15.5 cm (6")
SI-020-20	20 cm (8")
SI-020-25	24.5 cm (9 3/4")
SI-020-30	30 cm (11 3/4")



Allis-Adair Intestinal and Tissue Grasping Forcep
 10 x 11 Teeth

Catalog #	Size
SI-024-15	16 cm (6 1/4")



Intestinal and Tissue Grasping Forceps
 Darm- und Gewebefasszangen
 Pinzas para intestinos y tejidos
 Pinces pour saisir intestins et tissus
 Pinze per afferrare intestino e tessuti

Boys-Allis Intestinal and Tissue Grasping Forcep
 5 x 6 Teeth



Catalog #	Size
SI-026-15	15.5 cm (6")

Judd-Allis Intestinal and Tissue Grasping Forcep
 3 x 4 Teeth



Catalog #	Size
SI-028-15	15.5 cm (6")
SI-028-19	19 cm (7 1/2")

Thomas-Allis Intestinal and Tissue Grasping Forcep
 6 x 7 Teeth



Catalog #	Size
SI-030-20	20.5 cm (8")

Allis Intestinal and Tissue Grasping Forcep
 5 x 6 Teeth



Catalog #	Size
SI-032-20	20 cm (8")

Lockwood Intestinal and Tissue Grasping Forcep



Catalog #	Size
SI-040-20	20 cm (8")

Intestinal and Tissue Grasping Forceps
 Darm- und Gewebefasszangen
 Pinzas para intestinos y tejidos
 Pincas pour saisir intestins et tissus
 Pinze per afferrare intestino e tessuti

Littlewood Intestinal and Tissue Grasping Forcep



Catalog #	Size
SI-042-18	18.5 cm (7 1/4")

Williams Intestinal and Tissue Grasping Forcep



Catalog #	Size
SI-050-16	16.5 cm (6 1/2")

UltaGrip™ TC Babcock Intestinal and Tissue Grasping Forcep

ULTRA Grip™

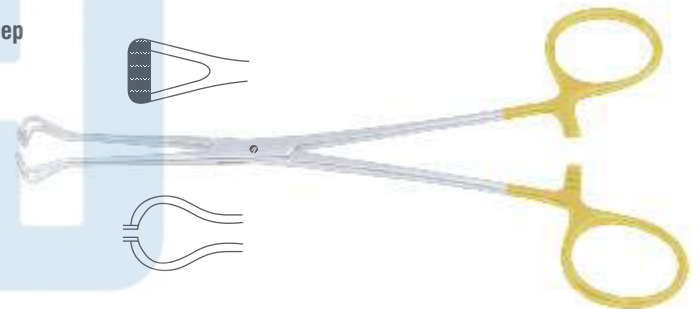

Catalog #	Size
SI-056-16	16.5 cm (6 1/2")
SI-056-20	21 cm (8 1/4")

Babcock Intestinal and Tissue Grasping Forcep



Catalog #	Size
SI-060-16	15.5 cm (6")
SI-060-18	17.5 cm (7")
SI-060-20	21 cm (8 1/4")
SI-060-24	24 cm (9 1/2")

Babcock Atrauma Intestinal and Tissue Grasping Forcep



Catalog #	Size
SI-062-16	16 cm (6 1/4")
SI-062-20	20.5 cm (8")

INCHES
MILLIMETERS

Intestinal and Tissue Grasping Forceps
 Darm- und Gewebefasszangen
 Pinzas para intestinos y tejidos
 Pinces pour saisir intestins et tissus
 Pinze per afferrare intestino e tessuti

UltraGrip™ TC Duval Intestinal and Tissue Grasping Forcep

ULTRA Grip™



Catalog #	Size
SI-070-20	20.5 cm (8")

**Duval Intestinal and Tissue Grasping Forcep
Narrow Jaw**



Catalog #	Size
SI-072-18	18 cm (7")

**Duval Intestinal and Tissue Grasping Forcep
Wide Jaw**

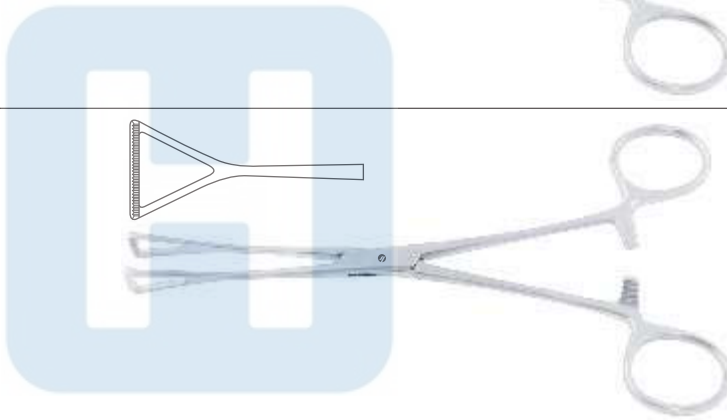

Catalog #	Size
SI-074-23	23 cm (9")

**Doyen-Baby Intestinal Clamp
Straight**



Catalog #	Size
SI-100-18	18 cm (7")

**Doyen-Baby Intestinal Clamp
Curved**



Catalog #	Size
SI-101-18	17.5 cm (7")

Intestinal Clamps
 Darmklemmen
 Pinzas intestinales
 Pincas intestinales
 Pinze intestinali

Doyen Intestinal Clamp
 Straight



Catalog #	Size
SI-102-23	23.5 cm (9 1/4")

Doyen Intestinal Clamp
 Curved



Catalog #	Size
SI-103-23	23 cm (9")

Mayo-Robson Intestinal Clamp
 Straight

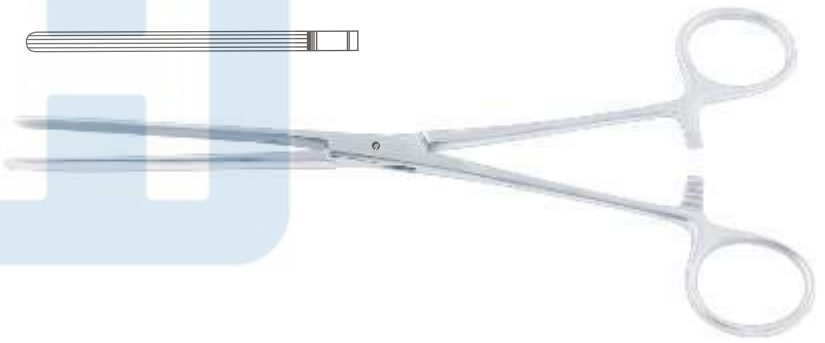

Catalog #	Size
SI-110-21	21.5 cm (8 1/2")
SI-110-23	23.5 cm (9 1/4")
SI-110-25	25.5 cm (10")

Mayo-Robson Intestinal Clamp
 Curved



Catalog #	Size
SI-111-21	21.5 cm (8 1/2")
SI-111-23	23 cm (9")
SI-111-25	24.5 cm (9 3/4")

Kocher-Baby Intestinal Clamp
 Straight

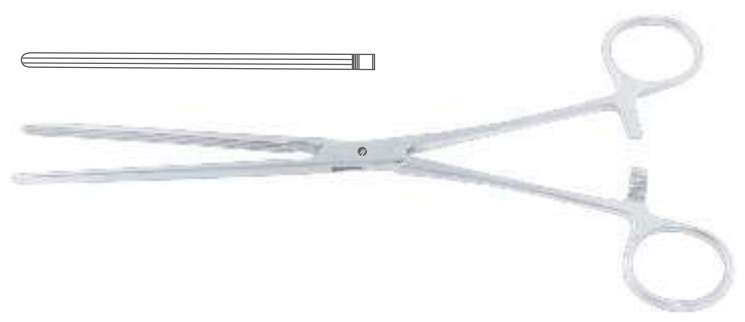

Catalog #	Size
SI-120-13	13 cm (5")

Intestinal Clamps
Darmklemmen
Pinzas intestinales
Pinces intestinales
Pinze intestinali

SI

STOMACH, INTESTINES, RECTUM

Kocher-Baby Intestinal Clamp
Curved



Catalog #	Size
SI-121-13	13 cm (5")

Kocher Intestinal Clamp
Straight

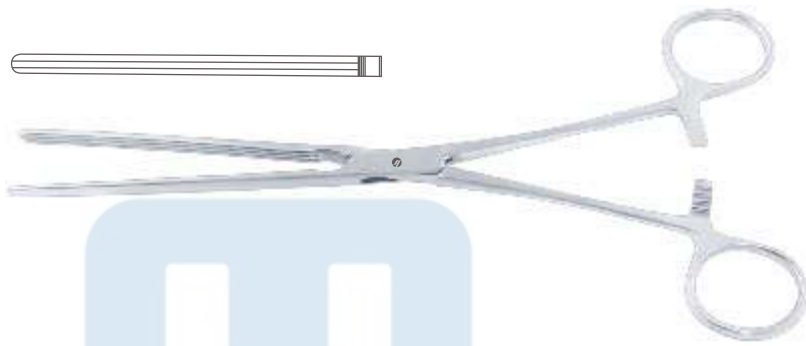

Catalog #	Size
SI-122-22	22.5 cm (8 3/4")
SI-122-25	25 cm (9 3/4")
SI-122-28	28.5 cm (11 1/4")

Kocher Intestinal Clamp
Curved

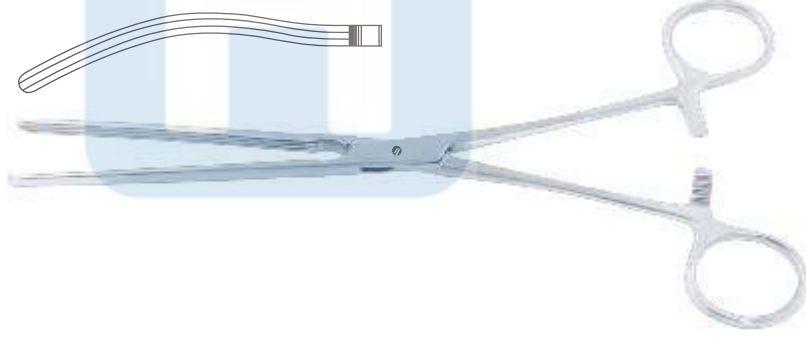

Catalog #	Size
SI-123-22	22.5 cm (8 3/4")
SI-123-25	24.5 cm (9 3/4")
SI-123-28	27.5 cm (10 3/4")

Allen Intestinal Clamp



Catalog #	Size
SI-128-16	16 cm (6 1/4")

Payr-Baby Intestinal Clamp



Catalog #	Size
SI-131-15	15 cm (6")

Intestinal Clamps
 Darmklemmen
 Pinzas intestinales
 Pinces intestinales
 Pinze intestinali

Payr Intestinal Clamp



Catalog #	Size
SI-133-21	20.5 cm (8")
SI-133-29	29 cm (11 1/2")
SI-133-35	34.5 cm (13 1/2")

Nussbaum Intestinal Clamp
 Straight

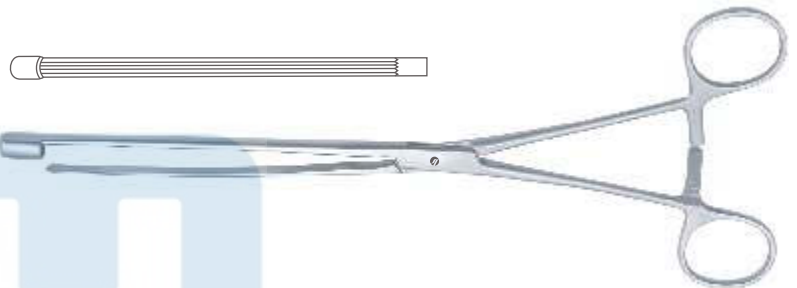

Catalog #	Size
SI-138-25	25 cm (9 3/4")

Nussbaum Intestinal Clamp
 Curved

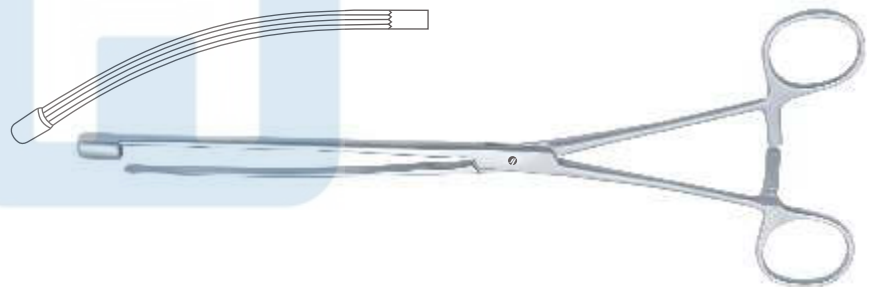

Catalog #	Size
SI-139-25	25 cm (9 3/4")

Lane Intestinal Clamp
 Straight

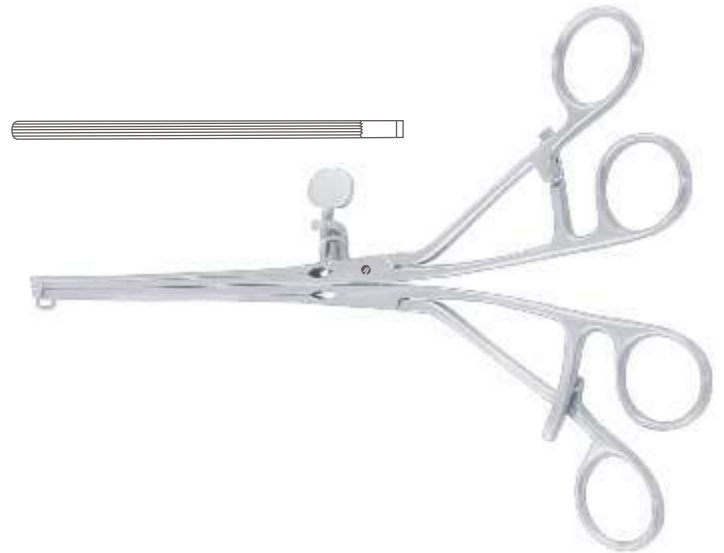

Catalog #	Size
SI-150-30	30 cm (11 3/4")

Intestinal Clamps
Darmklemmen
Pinzas intestinales
Pinces intestinales
Pinze intestinali

SI

STOMACH, INTESTINES, RECTUM

Lane Intestinal Clamp
Curved

Catalog #	Size
SI-151-30	30 cm (11 3/4")

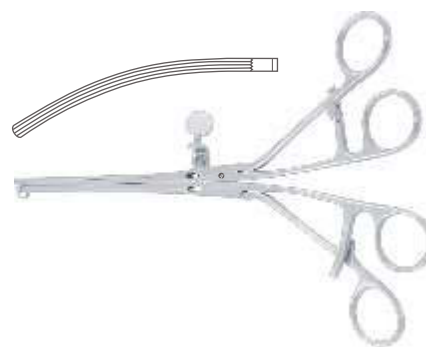

Haberer Intestinal Clamp

Catalog #	Size
SI-156-36	36 cm (14 1/4")

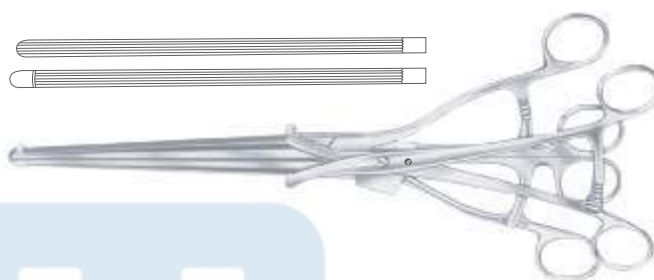

Scudder Intestinal Clamp
Straight

Catalog #	Size
SI-160-33	33.5 cm (13 1/4")



Scudder Intestinal Clamp
Curved

Catalog #	Size
SI-161-33	32.5 cm (12 3/4")



Brunner Sigmoid Anastomosis Clamp

Catalog #	Size
SI-165-24	24 cm - (9 1/2")



Intestinal Clamps
 Darmklemmen
 Pinzas intestinales
 Pinces intestinales
 Pinze intestinali

De Martel-Wolfson Intestinal Anastomosis Clamp
 Set of 3 Ref: SI-172-01 to SI-172-03

Catalog #	Size
SI-170-00	Standard



De Martel-Wolfson Intestinal Anastomosis Clamp

Catalog #	Jaw Length
SI-172-01	65 mm
SI-172-02	80 mm
SI-172-03	110 mm

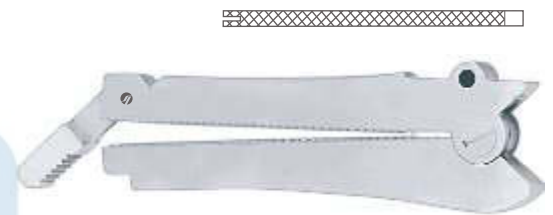

De Martel-Wolfson Closing Forcep

Catalog #	Size
SI-179-25	25 cm (9 3/4")



De Martel-Wolfson Clamp Holder

Catalog #	Size
SI-180-09	9.5 cm (3 3/4")
SI-180-23	23 cm (9")



Benson Pylorus Spreader

Catalog #	Size
SI-186-15	15.5 cm (6")



Intestinal Clamps
 Darmklemmen
 Pinzas intestinales
 Pinces intestinales
 Pinze intestinali

Scheibe (Collin) Atrauma Organ Grasping



Catalog #	Size, Profile
SI-190-18	18 cm (7"), Narrow Jaw
SI-190-20	20.5 cm (8"), Medium Jaw
SI-190-23	23 cm (8"), Wide Jaw

Doyen-Baby Atrauma Intestinal Clamp
 Straight

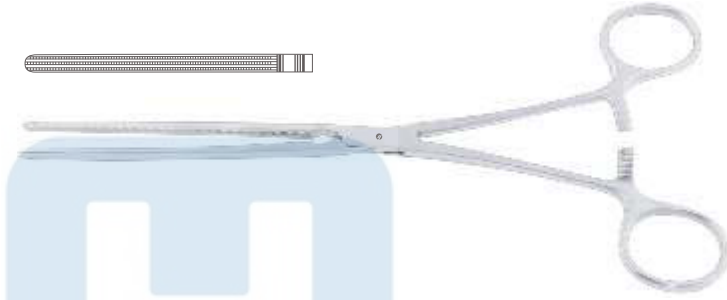

Catalog #	Size
SI-200-13	14 cm (5")

Doyen-Baby Atrauma Intestinal Clamp
 Curved

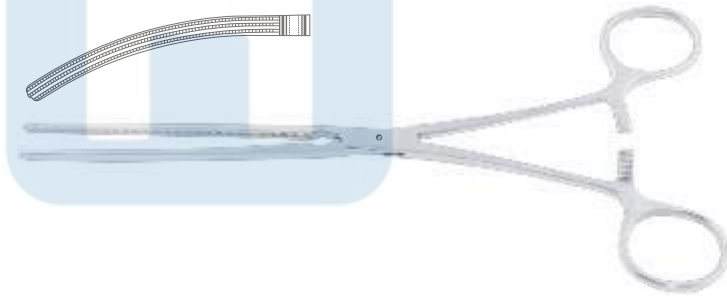
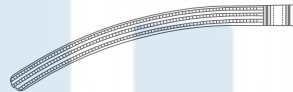

Catalog #	Size
SI-201-13	13.5 cm (5 1/4")

Doyen Atrauma Intestinal Clamp
 Straight

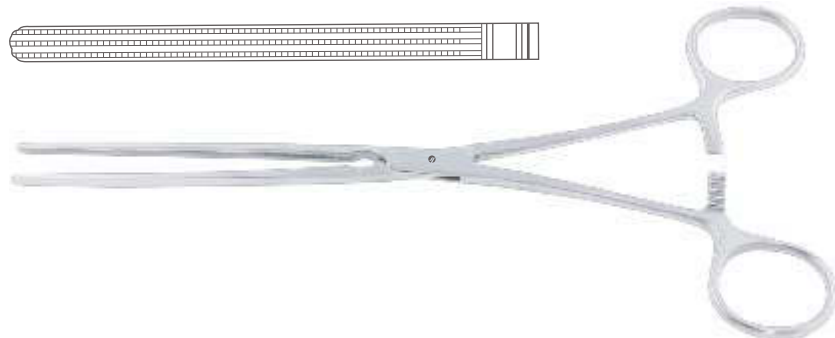

Catalog #	Size
SI-202-16	17 cm (6 3/4")
SI-202-18	18.5 cm (7 1/4")
SI-202-21	21.5 cm (8 1/2")
SI-202-23	23.5 cm (9 1/4")

Intestinal Clamps
 Darmklemmen
 Pinzas intestinales
 Pinces intestinales
 Pinze intestinali

Doyen Atrauma Intestinal Clamp
 Curved

Catalog #	Size
SI-203-16	17 cm (6 ¾")
SI-203-18	18 cm (7")
SI-203-21	21 cm (8 ¼")
SI-203-23	23 cm (9")

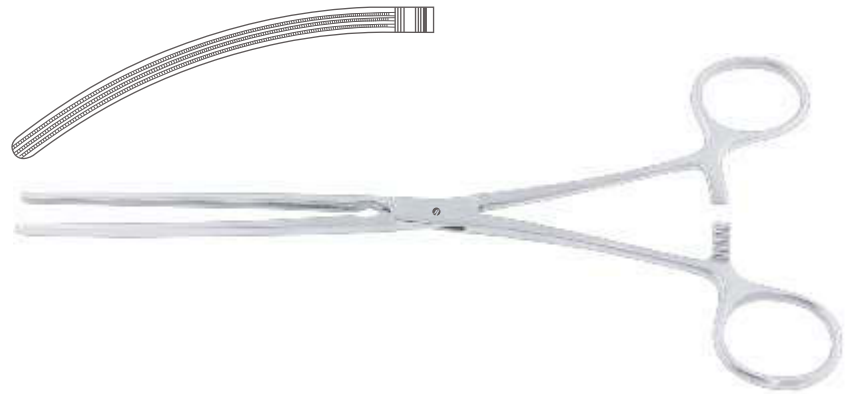

Mayo-Robson Atrauma Intestinal Clamp
 Straight

Catalog #	Size
SI-210-25	26 cm (10 ¼")



Mayo-Robson Atrauma Intestinal Clamp
 Curved

Catalog #	Size
SI-211-25	25 cm (9 ¾")

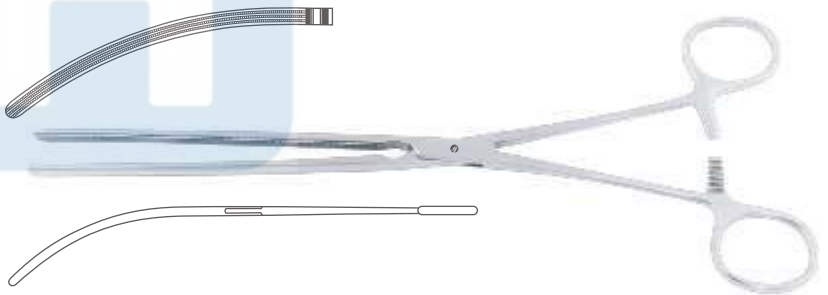

Kocher Atrauma Intestinal Clamp
 Straight

Catalog #	Size
SI-220-22	22.5 cm (8 ¾")
SI-220-25	25.5 cm (10")
SI-220-28	28 cm (11")



Intestinal Clamps
Darmklemmen
Pinzas intestinales
Pinces intestinales
Pinze intestinali

SI

STOMACH, INTESTINES, RECTUM

Kocher Atrauma Intestinal Clamp
Curved

Catalog #	Size
SI-221-22	22 cm (8 ¾")
SI-221-25	25 cm (9 ¾")
SI-221-28	27.5 cm (10 ¾")

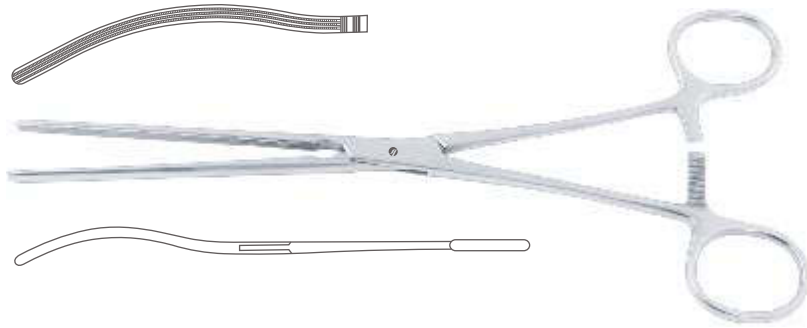

Scudder Atrauma Intestinal Clamp
Straight

Catalog #	Size
SI-230-33	33.5 cm (13 ¼")

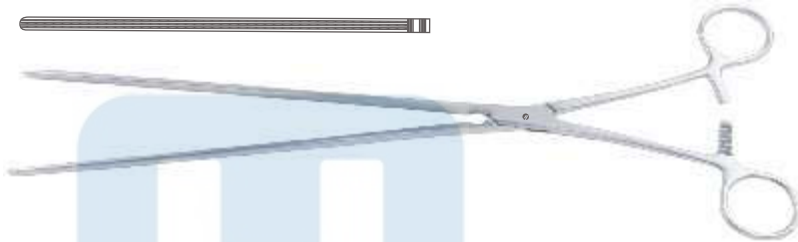

Scudder Atrauma Intestinal Clamp
Curved

Catalog #	Size
SI-231-33	32.5 cm (12 ¾")

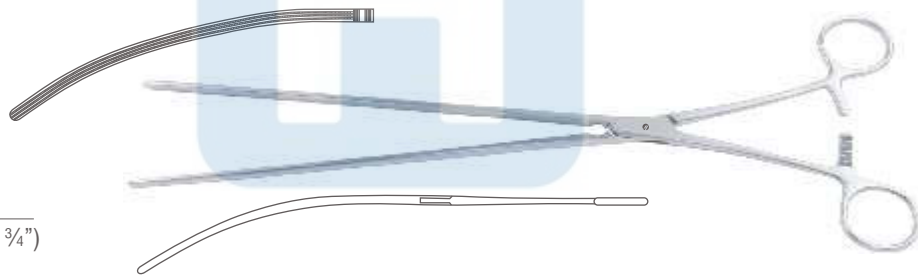

Brunner Atrauma Sigmoid Anastomosis Clamp

Catalog #	Size
SI-241-27	27 cm (10 ¾")

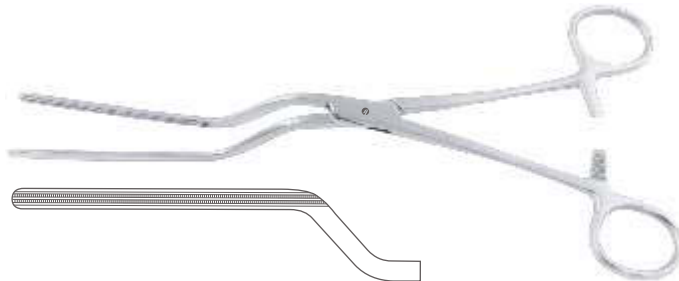

Hayes Atrauma Sigmoid Anastomosis Clamp

Catalog #	Size
SI-251-26	27 cm (10 ¾")
SI-251-28	28 cm (11")



Intestinal Clamps, Rectal Specula
 Darmklemmen, Mastdarmspekula
 Pinzas intestinales, Espéculos rectales
 Pinces intestinales, Spécuments rectaux
 Pinze intestinali, Specoli rettali

Veidenheimer Atrauma Sigmoid Anastomosis Clamp

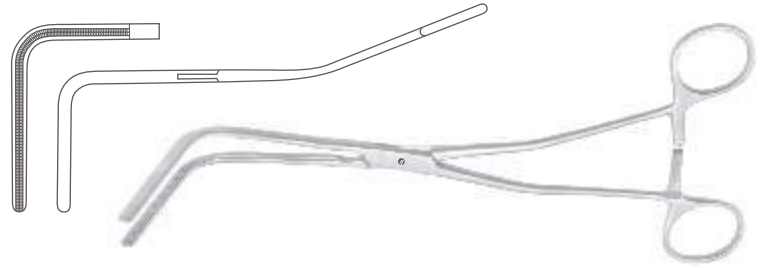

Catalog #	Size
SI-255-23	25 cm (9 3/4")

Fehland Atrauma Sigmoid Anastomosis Clamp



Catalog #	Size
SI-259-24	24 cm (9 1/2")

Resano Atrauma Sigmoid Anastomosis Clamp

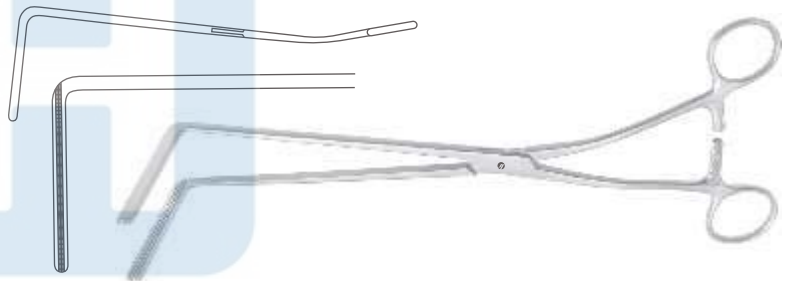

Catalog #	Size
SI-261-30	28 cm (11")

Czerny Rectal Speculum



Catalog #	Size
SI-301-22	22 cm (8 3/4")

Pratt Rectal Speculum



Catalog #	Size, Blade Size
SI-311-20	20.5 cm (8"), 80 x 25 mm

Rectal Specula
 Mastdarmspekula
 Espécules rectales
 Spéculums rectaux
 Specoli rettali

Sims Rectal Speculum



Catalog #	Size, Blade Size
SI-321-15	15.5 cm (6"), 70 x 15 mm

**Sims Rectal Speculum
 With Fiber Optic Illumination**



Fiber Optic No Shown

Catalog #	Size
SI-323-15	15.5 cm (6")

**Sims Rectal Speculum
 Fenestrated Blades**



Catalog #	Size, Blade Size
SI-327-15	15.5 cm (6"), 70 x 15 mm

Sims (Schulze-Bergmann) Rectal Speculum



Catalog #	Size, Blade Size
SI-331-01	22 cm (8 3/4"), 60 mm
SI-331-02	22 cm (8 3/4"), 80 mm
SI-331-03	22 cm (8 3/4"), 125 mm
SI-331-04	22 cm (8 3/4"), 150 mm

**Sims (Schulze-Bergmann) Rectal Speculum
 With Fiber Optic Illumination**



Fiber Optic No Shown

Catalog #	Size
SI-335-22	22 cm (8 3/4")

Rectal Specula
 Mastdarmspekula
 Espéculos rectales
 Spéculums rectaux
 Specoli retтали

Mathieu Rectal Speculum



Catalog #	Size, Blade Length
SI-341-19	19.5 cm (7 3/4"), 90 mm

Barr Rectal Speculum



Catalog #	Size, Blade Size
SI-343-17	17 cm (6 3/4"), 70 x 22 mm

Parks Rectal Speculum



Catalog #	Size
SI-351-00	Standard

**Parks Rectal Speculum
 With Fiber Optic Illumination**

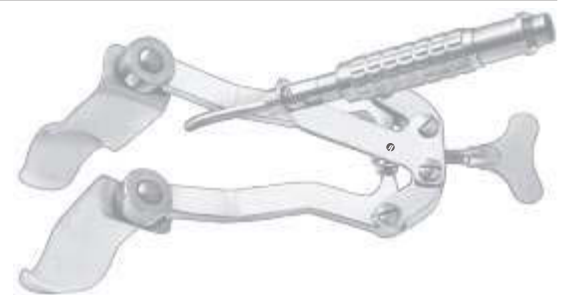

Catalog #	Size
SI-355-00	Standard

Alan-Parks Rectal Speculum



Catalog #	Size
SI-361-00	Standard

Rectal Spreaders, Anuscope
 Analspreizer, Anuskop
 Separadores rectales, Anoscopio
 Ecarteurs rectaux, Anuscope
 Divaricatori rettali, Anoscopio

Alan-Parks Rectal Speculum
 With Fiber Optic Illumination

Catalog #	Size
SI-365-00	Standard



Roschke Anal Retractor

Catalog #	Blade Size
SI-371-00	70 x 30 mm



Roschke Anal Retractor
 With Fiber Optic Illumination

Catalog #	Blade Size
SI-375-00	70 x 30 mm



Hirschmann Anoscope

Catalog #	Diameter, Working Length, Profile
SI-381-01	Ø 16 mm, 60 mm, Fig. 1
SI-381-02	Ø 19 mm, 70 mm, Fig. 2
SI-381-03	Ø 24 mm, 90 mm, Fig. 3
SI-381-04	Ø 24 mm, 130 mm, Fig. 4



Hirschman Anoscope
 With Fiber Optic Illumination

Catalog #	Diameter, Working Length, Profile
SI-385-01	Ø 16 mm, 60 mm, Fig. 1
SI-385-02	Ø 19 mm, 70 mm, Fig. 2
SI-385-03	Ø 24 mm, 90 mm, Fig. 3
SI-385-04	Ø 24 mm, 130 mm, Fig. 4



Anuscope
Anuskop
Anoscopio
Anuscope
Anoscopio

Ives-Fansler Anoscope



Catalog #	Diameter, Working Length
SI-391-00	Ø 22 mm, 95 mm

**Ives-Fansler Anoscope
With Fiber Optic Illumination**



Catalog #	Diameter, Working Length
SI-395-00	Ø 22 mm, 95 mm

**Anoscope
With Obturator**



Catalog #	Diameter, Working Length
SI-401-00	Ø 21 mm, 80 mm

**Anoscope
With Obturator**



Catalog #	Diameter, Working Length
SI-403-01	Ø 26 mm, 60 mm
SI-403-02	Ø 24 mm, 80 mm

Kelly Proctoscope



Catalog #	Diameter, Working Length, Profile
SI-411-01	Ø 22 mm, 50 mm, Fig. 1
SI-411-02	Ø 22 mm, 100 mm, Fig. 2
SI-411-03	Ø 22 mm, 140 mm, Fig. 3
SI-411-04	Ø 22 mm, 200 mm, Fig. 4

Proctoscopes
 Proktoskope
 Proctoscopios
 Proctoscopes
 Protoscopi

Proctoscope
 With Obturator



Catalog #	Diameter, Working Length
SI-415-00	Ø 22 mm, 120 mm

Blond Proctoscope Complete

With Conventional Illumination and Tube Ref: SI-440-01



Catalog #	Size
SI-431?-00	Standard

Battery Handle Only

For 2 x "C" Type Batteries



Catalog #	Size
SI-431-01	Standard

Head End Only



Catalog #	Size
SI-431-02	Standard

Bulb

Head End Only



Catalog #	Power Rating
SI-431-09	2.5

Proctoscopes
 Proktoskope
 Proctoscopios
 Proctoscopes
 Protoscopi

Bulb
 Short for Head End Only



Catalog #	Power Rating
SI-431-10	2.5

Blond Proctoscope Complete
 With Fiber Optic Illumination and Tube Ref: SI-440-01

Catalog #	Size
SI-435-00	Standard



Illumination Handle only
 With Head End

Catalog #	Size
SI-435-01	Standard



Adaptor
 Storz Type

Catalog #	Size
SI-435-05	Standard



Blond Proctoscope Tube

Catalog #	Diameter, Working Length
SI-440-01	Ø 18:24 mm, 75 mm
SI-440-02	Ø 15:23 mm, 75 mm
SI-440-03	Ø 18:25 mm, 105 mm



SI-440-01



SI-440-02



SI-440-03



Proctoscopes
 Proktoskope
 Proctoscopios
 Proctoscopes
 Protoscopi

Blond Proctoscope Tube
 Circular Fenestration



Catalog #	Diameter, Working Length
SI-442-01	Ø 18:24 mm, 75 mm

Morgan Proctoscope
 With Fiber Optic Illumination



Catalog #	Diameter, Working Length
SI-451-01	Ø 17 mm, 65 mm
SI-451-02	Ø 17 mm, 80 mm
SI-451-03	Ø 20 mm, 65 mm
SI-451-04	Ø 20 mm, 80 mm
SI-451-05	Ø 24 mm, 65 mm
SI-451-06	Ø 24 mm, 80 mm

Morgan Fibre Optic Illuminator
 Connectors Type Storz, Wolf, ACM



Catalog #	Size
SI-455-00	Standard

Kelly Sphincteroscope



Catalog #	Diameter, Diameter, Profile
SI-471-01	Ø 21 mm, 50 mm, Fig. 1
SI-471-02	Ø 27 mm, 50 mm, Fig. 2

Sphincteroscopes, Rectoscopes
 Sphinkteroskope, Rektoskope
 Esfincteroscopios, Rectoscopios
 Sphinctérosopes, Rectoscopes
 Sfincteroscopi, Rectotoscopi

Rectoscope Complete



Catalog #	Size
SI-500-00	Standard

Strauss Rectoscope Complete



Catalog #	Size
SI-510-00	Standard

Recto-Proctoscope Complete

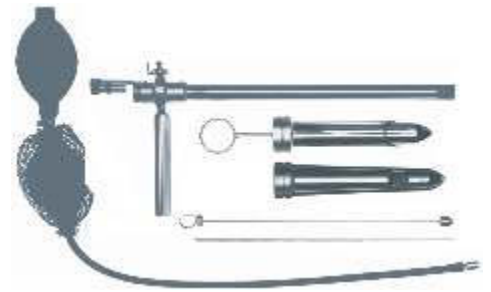

Catalog #	Size
SI-520-00	Standard

Battery Handle Only

For 2 x "AAA" Type Batteries



Catalog #	Size
SI-530-01	Standard

Spare Bulb

Xenon



Catalog #	Power Rating
SI-530-09	2.5 V



INCHES
MILLIMETERS

Sphincteroscopes, Rectoscopes
Sphinkterskope, Rektoskope
Esfincteroscopios, Rectoscopios
Sphinctérosopes, Rectoscopes
Sfincteroscopi, Rectotoscopi

Adapter
Wolf Type

Catalog #	Size
SI-532-01	Standard



Adapter
Storz / Olympus Type

Catalog #	Size
SI-532-02	Standard



Adapter
Storz / Olympus Type / Aesculap Type

Catalog #	Size
SI-532-03	Standard



Rectoscope Head
With 2 Way Stopcock, Connector Type Wolf

Catalog #	Size
SI-534-01	Standard



Handle for Rectoscope Head

Catalog #	Size
SI-534-02	Standard



Rectoscopes
 Rektoskope
 Rectoscopios
 Rectoscopes
 Rectotoscopi

Rectoscope Obturator



Catalog #	Size
SI-536-01	Standard
SI-536-02	Standard
SI-536-03	Standard

Rectoscope Tube

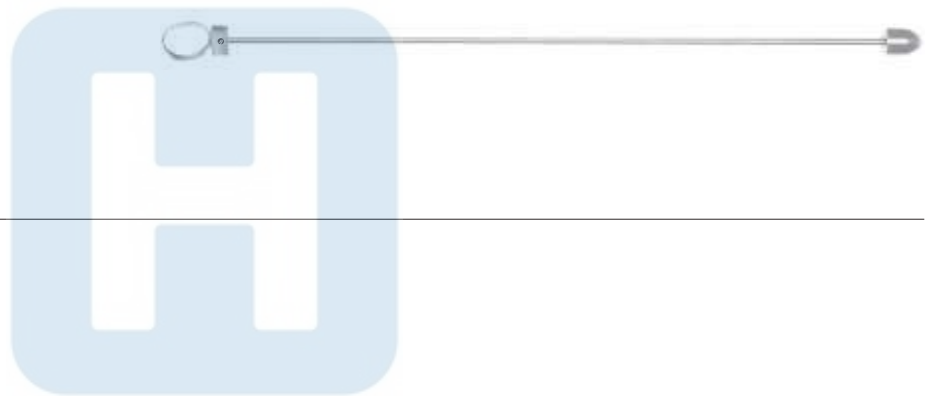

Catalog #	Size
SI-538-01	Standard
SI-538-02	Standard
SI-538-03	Standard

Fiber Optic Light Guide



Catalog #	Size
SI-540-01	Standard
SI-540-02	Standard
SI-540-03	Standard

Conical Tube



Catalog #	Size
SI-542-01	Standard

**Anuscope
 With Obturator**



Catalog #	Size
SI-544-01	Standard

Rectoscopes
Rektoskope
Rectoscopios
Rectoscopes
Rectotoscopi

Telescope

Catalog #	Size
SI-546-00	Standard



Swivel Lens

Catalog #	Size
SI-548-00	Standard

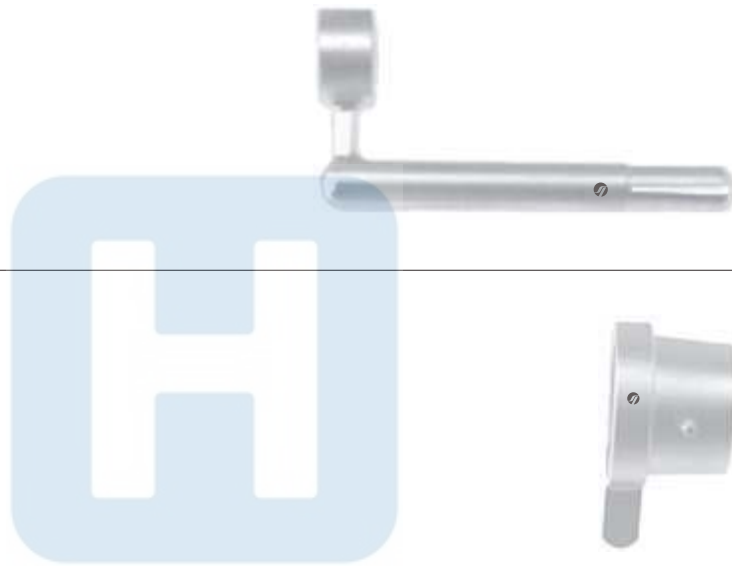

Cover

Catalog #	Size
SI-550-00	Standard



Double-Blower With Luer Lock

Catalog #	Size
SI-560-00	Standard



Norwood Rectal Snare

Catalog #	Size
SI-601-30	30 cm (11 3/4")



Hemorrhoidal Ligator
 Hämorrhoidal-Faßzange
 Ligador para hemorroides
 Ligateur pour hémorroïdes
 Legatore emorroidale

Blue Rectal Aspiration Cannula
 10 Charr.



Catalog #	Size, Diameter
SI-607-40	40 cm (15 3/4"), Ø 3.3 mm

McGivney Suction Hemorrhoidal Ligator Complete
 With 10 mm Suction Head and Charging Cone



Catalog #	Size
SI-651-00	Standard

Suction Hemorrhoidal Ligature Complete
 Angled 30° Up, With 10 mm Suction Head and Charging Cone



Catalog #	Size
SI-655-00	Standard

Suction Hemorrhoidal Ligator Complete
 Angled 30° Down, With 10 mm Suction Head and Charging Cone



Catalog #	Size
SI-657-00	Standard

Rudd Hemorrhoidal Ligator Complete
 With 12 mm Charging Cone



Catalog #	Size
SI-670-00	31.5 cm (12 1/2")

Hemorrhoidal Ligator, Rectal Biopsy Forceps
 Hämorrhoidal-Faßzange, Rektum-Biopsiefasszangen
 Ligador para hemorroides, Pinzas para biopsia rectal
 Ligateur pour hémorroïdes, Pincés pour biopsie rectale
 Legatore emorroidale, Pinze per biopsia rettale

McGivney Hemorrhoidal Ligator Complete
 With 12 mm Charging Cone



Catalog #	Size
SI-675-00	Standard

Ford Dixon Hemorrhoidal Ligator Complete
 With 12 mm Charging Cone

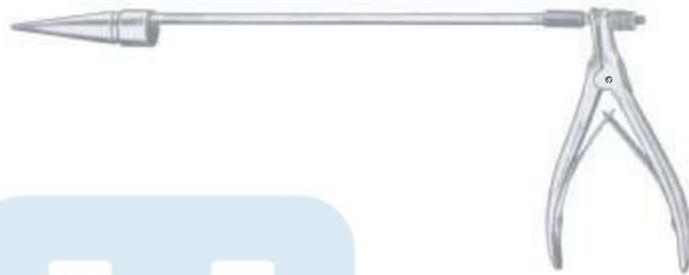

Catalog #	Size
SI-677-00	Standard

Rubber Ligator Rings
 Pack of 100



Catalog #	Size
SI-680-00	Standard

McGivney Hemorrhoidal Grasping Forcep

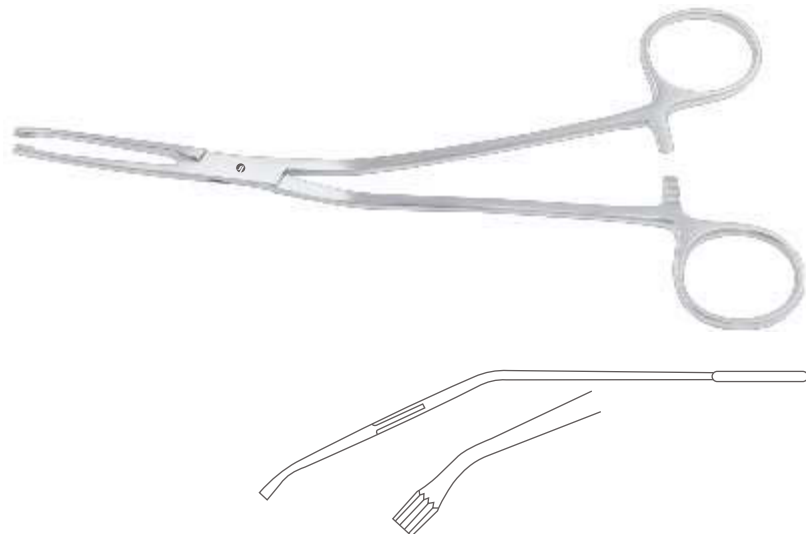



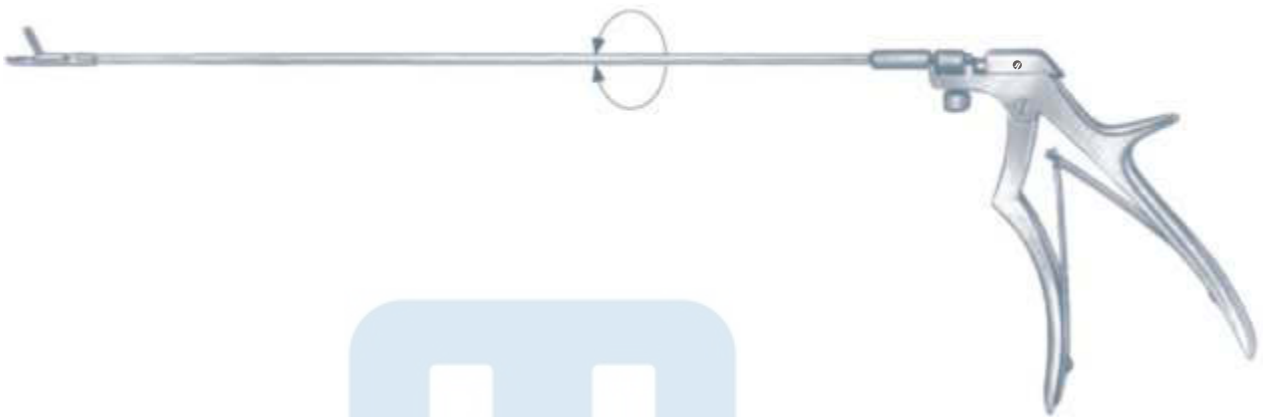

Catalog #	Size
SI-691?-19	19 cm (7 1/2")

Rectal Biopsy Forceps
 Rektum-Biopsiefasszangen
 Pinzas para biopsia rectal
 Pinces pour biopsie rectale
 Pinze per biopsia rettale

Yeoman (Turrell) Rectal Biopsy Forcep Without Handle
 Rotatable



Catalog #	Size
SI-725-42	42 cm (16 1/2"), Straight
SI-727-42	42 cm (16 1/2"), Down
SI-729-42	42 cm (16 1/2"), Straight
SI-731-42	42 cm (16 1/2"), Down
SI-733-42	42 cm (16 1/2"), Straight

-  SI-725-42, Straight
-  SI-727-42, Down
-  SI-729-42, Straight
-  SI-731-42, Down
-  SI-733-42, Straight

Handle Only

Catalog #	Size
SI-735-00	Standard



Rectal Biopsy Forceps
 Rektum-Biopsiefasszangen
 Pinzas para biopsia rectal
 Pincas pour biopsie rectale
 Pinze per biopsia rettale

Yeoman (Turrell) Rectal Biopsy Forcep Complete

Catalog #	Size, Profile
SI-735-01	42 cm (16 1/2"), Straight
SI-735-02	42 cm (16 1/2"), Down
SI-735-03	42 cm (16 1/2"), Straight
SI-735-04	42 cm (16 1/2"), Down
SI-735-05	42 cm (16 1/2"), Straight

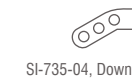

HOSPITA®

ALWAYS THE BEST

UR



LIVER, GALL BLADDER,
KIDNEY, UROLOGY

Hospita manufactures a broad range of instruments for specialist field of Liver, Gall bladder, Kidney and Urology surgery. Our range of liver instruments, gall bladder instruments, kidney instruments and urology instruments includes but is not limited to the following: non scalpel vasectomy forceps, kidney stone forceps, nephrostomy forceps, forceps, gall duct dilators, gall stone forceps, gall stone scoops, prostate ret capsule forceps, urethral sounds, female catheters, urethrotomes, circumcision instruments, urethrography instruments, foreign body instruments, penis clamps & hernia instruments.



Leber, Galle, Niere, Urologie

Higado, Biliares, Renales, Urología

Foie, Biliaire, Rénaux, Urologie

Fegato, Biliari, Renali, Urologia

Kidney Stone Forceps
 Nierensteinzangen
 Pinzas para cálculos renales
 Pinces pour les calculs du bassinet
 Pinze per calcoli renali

Vasectomy Dissecting Forcep

Catalog #	Size
UR-011-01	Standard



Vasectomy Fixation Clamp

Catalog #	Size
UR-014-02	Standard



Randall Kidney Stone Forcep
 Fig. 1

Catalog #	Size
UR-051-23	23 cm (9")

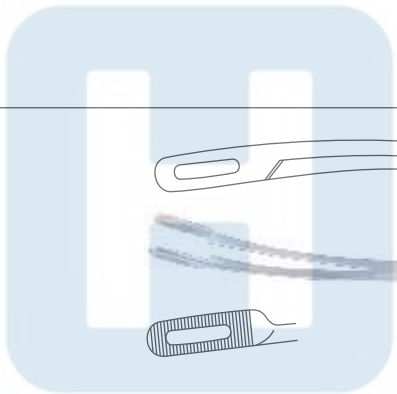

Randall Kidney Stone Forcep
 Fig. 2

Catalog #	Size
UR-053-21	21 cm (8 1/4")



Randall Kidney Stone Forcep
 Fig. 3

Catalog #	Size
UR-055-19	19 cm (7 1/2")

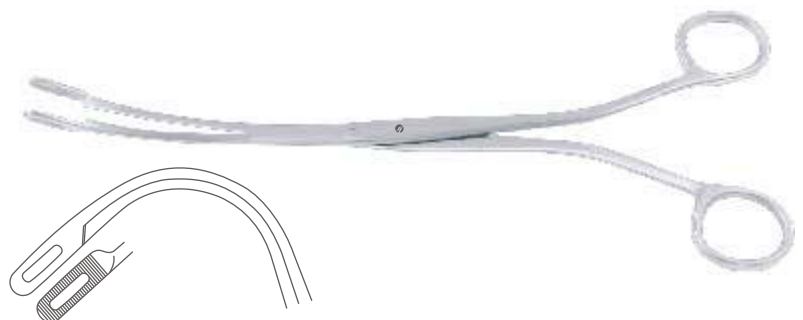

Kidney Stone Forceps
 Nierensteinzangen
 Pinzas para cálculos renales
 Pincas pour les calculs du bassin
 Pinze per calcoli renali

Randall Kidney Stone Forcep
 Fig. 4

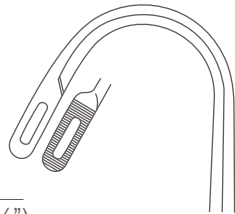

Catalog #	Size
UR-057-18	18.5 cm (7 1/2")



Randall Kidney Stone Forcep
 Fig. 5

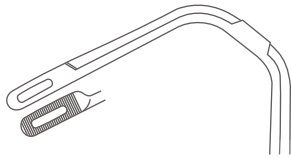

Catalog #	Size
UR-059-19	19 cm (7 1/2")



Randall Kidney Stone Forcep
 Fig. 6

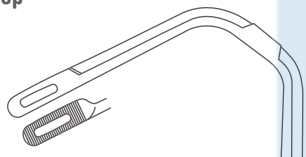

Catalog #	Size
UR-061-19	19 cm (7 1/2")



Randall Kidney Stone Forcep
 Fig. 1, Slender Pattern

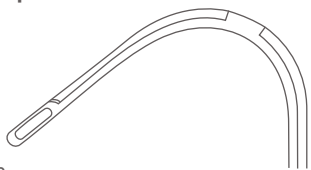

Catalog #	Size
UR-071-23	23 cm (9")



Randall Kidney Stone Forcep
 Fig. 2, Slender Pattern

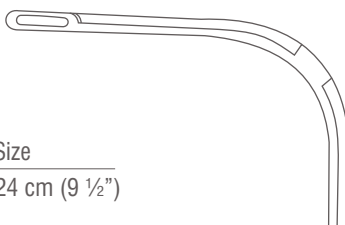

Catalog #	Size
UR-073-24	24 cm (9 1/2")



Kidney Stone Forceps
 Nierensteinzangen
 Pinzas para cálculos renales
 Pinces pour les calculs du bassin
 Pinze per calcoli renali

Heiming Kidney Stone Forcep
 Fig. 1

Catalog #	Size
UR-081-16	16 cm (6 1/4")



Heiming Kidney Stone Forcep
 Fig. 2

Catalog #	Size
UR-083-17	17 cm (6 3/4")



Elsaesser Nephrectomy Forcep

Catalog #	Size, Profile
UR-091-01	21 cm (8 1/4"), Fig. 1
UR-091-02	21 cm (8 1/4"), Fig. 2

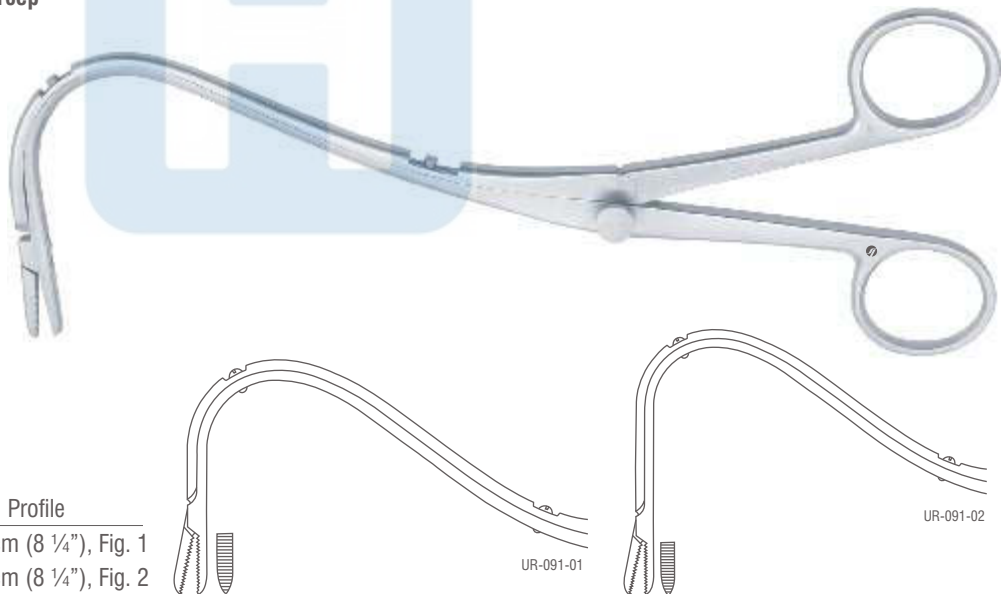

Bakes Gall Duct Dilators
 Set of 13 Ref: UR-150-01 to UR-150-13

Catalog #	Size
UR-150-00	Standard



Gall Duct Dilators
 Gallenkanaldilatatoren
 Dilatadores para conducto biliar
 Dilatateurs pour les voies biliaires
 Dilatatori per condotti biliari

Bakes Gall Duct Dilator



Catalog #	Size, Diameter, Profile
UR-150-01	32 cm (12 1/2"), Ø 1 mm, Fig. 1
UR-150-02	32 cm (12 1/2"), Ø 2 mm, Fig. 2
UR-150-03	32 cm (12 1/2"), Ø 3 mm, Fig. 3
UR-150-04	32 cm (12 1/2"), Ø 8 mm, Fig. 4
UR-150-05	32 cm (12 1/2"), Ø 6 mm, Fig. 5
UR-150-06	32 cm (12 1/2"), Ø 7 mm, Fig. 6
UR-150-07	32 cm (12 1/2"), Ø 8 mm, Fig. 7
UR-150-08	32 cm (12 1/2"), Ø 9 mm, Fig. 8
UR-150-09	32 cm (12 1/2"), Ø 10 mm, Fig. 9
UR-150-10	32 cm (12 1/2"), Ø 11 mm, Fig. 10
UR-150-11	32 cm (12 1/2"), Ø 12 mm, Fig. 11
UR-150-12	32 cm (12 1/2"), Ø 13 mm, Fig. 12
UR-150-13	32 cm (12 1/2"), Ø 13 mm, Fig. 13

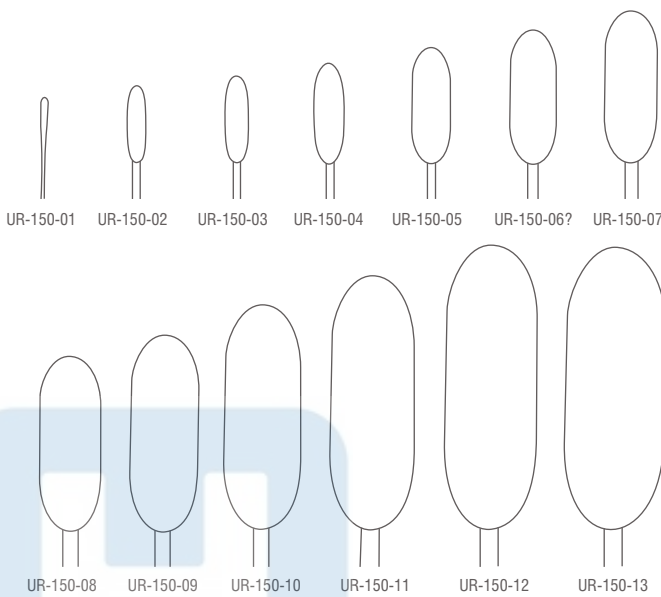

Bakes Gall Stone Forcep Straight



Catalog #	Size
UR-180-20	21 cm (8 1/4")

Bakes Gall Stone Forcep Curved



Catalog #	Size
UR-181-20	21 cm (8 1/4")

Mayo-Bakes Gall Stone Forcep Straight



Catalog #	Size
UR-184-20	21 cm (8 1/4")

Gall Stone Forceps
 Gallensteinzangen
 Pinzas para cálculos biliares
 Pinces pour calculs biliaires
 Pinze per calcoli biliari

Mayo-Bakes Gall Stone Forcep
 Curved

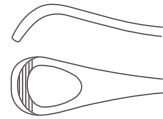

Catalog #	Size
UR-185-20	21 cm (8 1/4")

Mixter Gall Stone Forcep



Catalog #	Size
UR-189-22	22 cm (8 3/4")

Desjardins Gall Stone Forcep
 Fig. 1

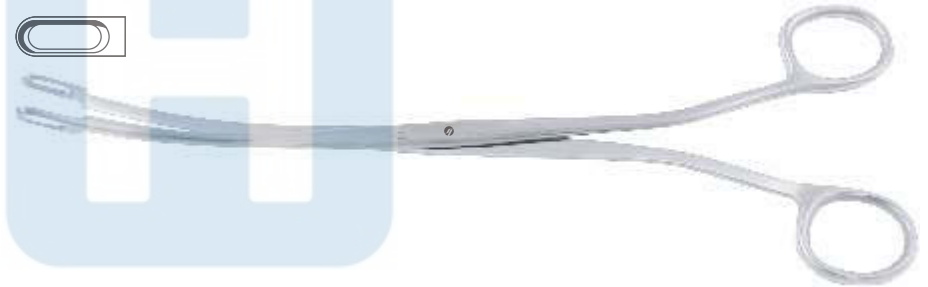

Catalog #	Size
UR-191-23	23 cm (9")

Desjardins Gall Stone Forcep
 Fig. 2



Catalog #	Size
UR-193-23	23 cm (9")

Prostatic Retractors
 Prostatahaken
 Separadores para próstata
 Ecarteurs prostatiques
 Divaricatori prostatici

Luer-Koerte Gall Stone Scoop

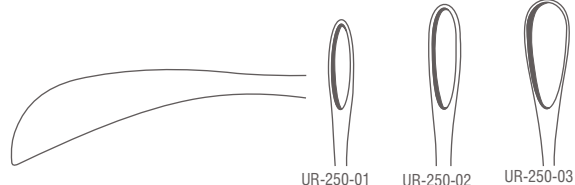

Catalog #	Size, Scoop Size, Profile
UR-250-01	32 cm (12 1/2"), Ø 2.7 mm, Fig. 000
UR-250-02	32 cm (12 1/2"), Ø 3.4 mm, Fig. 00
UR-250-03	32 cm (12 1/2"), Ø 4.3 mm, Fig. 0
UR-250-04	32 cm (12 1/2"), Ø 5.5 mm, Fig. 1
UR-250-05	32 cm (12 1/2"), Ø 6.6 mm, Fig. 2
UR-250-06	32 cm (12 1/2"), Ø 8.0 mm, Fig. 3
UR-250-07	32 cm (12 1/2"), Ø 11.0 mm, Fig. 4
UR-250-08	32 cm (12 1/2"), Ø 15.0 mm, Fig. 5

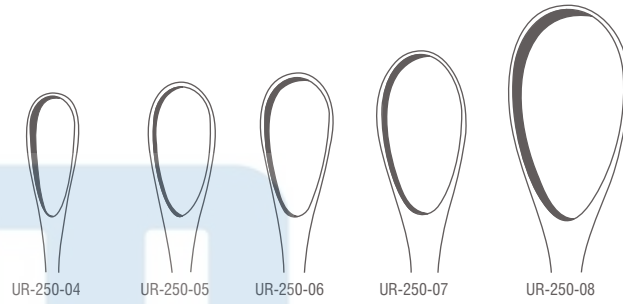

Young Prostatic Retractor

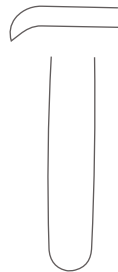

Catalog #	Size
UR-301-22	22 cm (8 3/4")

Young Prostatic Retractor

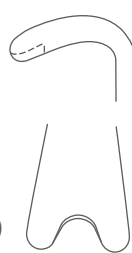

Catalog #	Size
UR-305-21	21.5 cm (8 1/2")

Young Prostatic Retractor

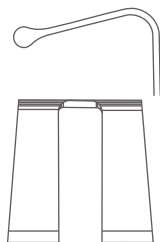

Catalog #	Size
UR-309-23	23 cm (9")

Capsule Forceps
 Kapselfasszangen
 Pinzas capsulares
 Pinces pour saisir les capsules
 Pinze per afferrare capsule

Millin Atrauma Capsule Forcep

Catalog #	Size
UR-451-24	24.5 cm (9 1/2")

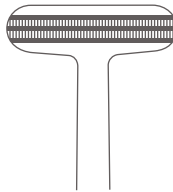

Millin Atrauma Capsule Forcep

Catalog #	Size
UR-453-22	22.5 cm (8 3/4")

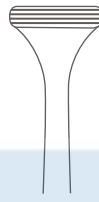

Millin Capsule Forcep

Catalog #	Size
UR-457-24	24.5 cm (9 1/2")

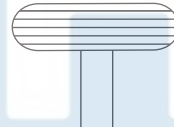

Millin Capsule Forcep

Catalog #	Size
UR-461-22	22 cm (8 3/4")



Van Buren Urethral Sound / Dilating Bougie

Set of 15 Ref: UR-501-08 to UR-501-36

Catalog #	Size
UR-501-00	Standard



Urethral Sounds
Harnröhrenbougies
Bujías uretrales
Bougies urétrales
Candelette dilatatrici

UR

LIVER, GALL BLADDER, KIDNEY, UROLOGY

Van Buren Urethral Sound / Dilating Bougie

Catalog #	Size, Profile
UR-501-08	27 cm (10 3/4"), 8 Charr.
UR-501-10	27 cm (10 3/4"), 10 Charr.
UR-501-12	27 cm (10 3/4"), 12 Charr.
UR-501-14	27 cm (10 3/4"), 14 Charr.
UR-501-16	27 cm (10 3/4"), 16 Charr.
UR-501-18	27 cm (10 3/4"), 18 Charr.
UR-501-20	27 cm (10 3/4"), 20 Charr.
UR-501-22	27 cm (10 3/4"), 22 Charr.
UR-501-24	27 cm (10 3/4"), 24 Charr.
UR-501-26	27 cm (10 3/4"), 26 Charr.
UR-501-28	27 cm (10 3/4"), 28 Charr.
UR-501-30	27 cm (10 3/4"), 30 Charr.
UR-501-32?	27 cm (10 3/4"), 32 Charr.?
UR-501-34	27 cm (10 3/4"), 34 Charr.
UR-501-36	27 cm (10 3/4"), 36 Charr.



Guyon Urethral Sound / Dilating Bougie

Set of 24 Ref: UR-511-10 to UR-511-30 and UR-580-03 to UR-580-06 in Metal Case

Catalog #	Size
UR-511-00	Standard

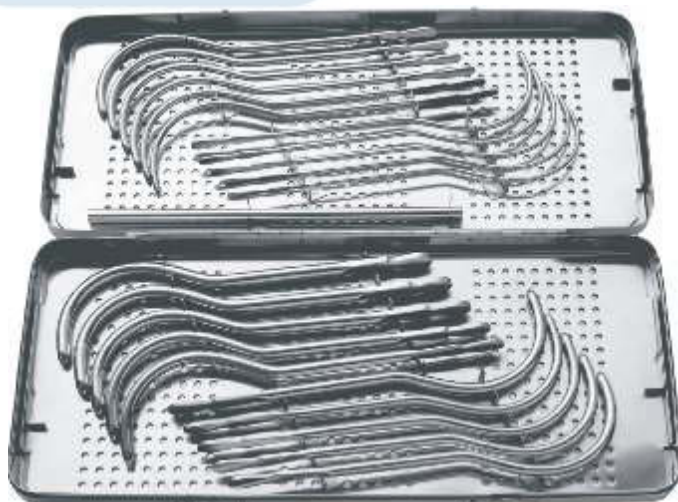

Urethral Sounds
Harnröhrenbougies
Bujias uretrales
Bougies urétrales
Candelette dilatatrici

Guyon Urethral Sound / Dilating Bougie

Catalog #	Size, Profile
UR-511-10	26.5 cm (10 1/2"), 10 Charr.
UR-511-11	26.5 cm (10 1/2"), 11 Charr.
UR-511-12	26.5 cm (10 1/2"), 12 Charr.
UR-511-13	26.5 cm (10 1/2"), 13 Charr.
UR-511-14	26.5 cm (10 1/2"), 14 Charr.
UR-511-15	26.5 cm (10 1/2"), 15 Charr.
UR-511-16	26.5 cm (10 1/2"), 16 Charr.
UR-511-17	26.5 cm (10 1/2"), 17 Charr.
UR-511-18?	26.5 cm (10 1/2"), 18 Charr.
UR-511-19	26.5 cm (10 1/2"), 19 Charr.
UR-511-20	26.5 cm (10 1/2"), 20 Charr.
UR-511-21	26.5 cm (10 1/2"), 21 Charr.
UR-511-22	26.5 cm (10 1/2"), 22 Charr.
UR-511-23	26.5 cm (10 1/2"), 23 Charr.
UR-511-24	26.5 cm (10 1/2"), 24 Charr.
UR-511-25	26.5 cm (10 1/2"), 25 Charr.
UR-511-26	26.5 cm (10 1/2"), 26 Charr.
UR-511-27	26.5 cm (10 1/2"), 27 Charr.
UR-511-28	26.5 cm (10 1/2"), 28 Charr.
UR-511-30	26.5 cm (10 1/2"), 30 Charr.



Female Catheter

Catalog #	Size, Profile
UR-515-10	15 cm (6"), 10 Charr.
UR-515-12	15 cm (6"), 12 Charr.
UR-515-14	15 cm (6"), 14 Charr.
UR-515-16	15 cm (6"), 16 Charr.
UR-515-18	15 cm (6"), 18 Charr.
UR-515-20	15 cm (6"), 20 Charr.



Catheter Introducer

Catalog #	Size
UR-519-00	46 cm (18")



Urethrotome, Urethrography- and Circumcision Instruments
 Urethrotom, Urethrographie- u. Circumcisions-Instrumente
 Uretrótomo, Instrumentos para uretrografía y circuncisión
 Urétrotome, Instruments pour uréthrographie et circoncision
 Uretrotomi, Strumenti per uretrografia e circuncisione

Otis Urethrotome
 With 2 Knives and 3 Tips

Catalog #	Size
UR-550-00	Standard

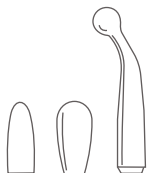

Otis Spare Blade

Catalog #	Size
UR-550-01	Standard



Filiform Urethral Sound / Dilating Bougie

Catalog #	Profile
UR-580-03	3 Charr.
UR-580-04	4 Charr.
UR-580-05	5 Charr.
UR-580-06	6 Charr.

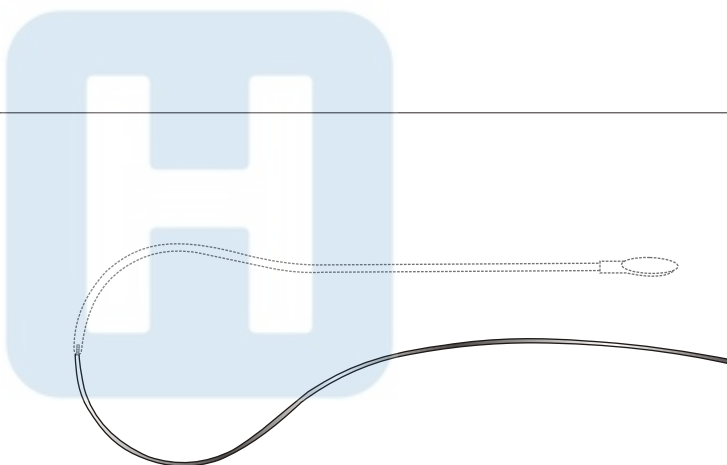

Knutson Urethrography Instrument

Catalog #	Size
UR-700-00	Standard



Circumcision Instruments
 Circumcisions-Instrumente
 para uretrografia y circuncisión
 pour urétrographie et circoncision
 per uretrografia e circoncisione

Gomco Circumcision Clamp

Catalog #	Diameter
UR-720-08	Ø 8 mm
UR-720-11	Ø 11 mm
UR-720-13	Ø 13 mm
UR-720-16	Ø 16 mm
UR-720-21	Ø 21 mm
UR-720-26	Ø 26 mm
UR-720-32	Ø 32 mm



Mogen Circumcision Clamp

Catalog #	Size
UR-740-00	7.5 cm (3")



Mathieu Foreign Body Forcep

Catalog #	Size
UR-801-20	20 cm (8")
UR-801-28	28 cm (11")



Sachse Meatotome

Catalog #	Size
UR-815-12	Standard



Circumcision Instruments
Circumcisions-Instrumente
para uretrografia y circuncisión
pour urétrographie et circoncision
per uretrografia e circoncisione

Stockman Penis Clamp

Catalog #	Size
UR-851-08	8 cm (3 1/4")



Strauss Penis Clamp

Catalog #	Size
UR-861-11	11 cm (4 1/2")



Collingwood-Stewart Hernia Ring Forcep

Catalog #	Size
UR-870-13	13 cm (5")

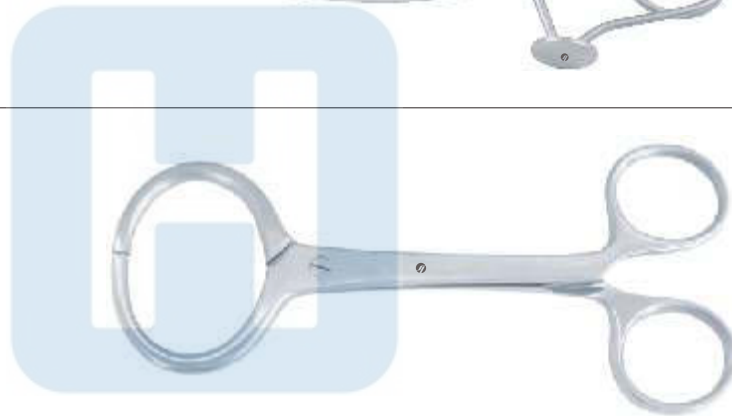

ALPHABETICAL INDEX



Alphabetical Index

A

	Page
Abdominal Spatula	325
Abraham Tonsil Knife	22
Adlercreutz Dissecting Forcep	152-153
Adson	
Dissecting Forcep	153, 211
Dressing Forcep	144, 211
Haemostatic Forcep	240
Needle Holder	430
Periosteal Elevator	563
Retractor Self-Retaining Retractor	336-337, 343-344
Suction Tube	401
Adson-Baby Dissecting & Ligature Forcep	251
Adson-Brown Dissecting Forcep	154, 211
Adson-Micro	
Dissecting Forcep	153
Dressing Forcep	144
Adson-Mini	
Dissecting Forcep	153
Dressing Forcep	144
Adventitia Micro Scissor	108
Akahoshi Phaco PreChopper	203
Alan-Parks Rectal Speculum	620-621
Albee Burr	503
Albee Pointed Cutter	503
Alderdyce Periosteal Elevator	565
Alexander	
Bone Chisel	522
Bone Gouge	522
Periosteal Elevator	562
Alfonso Nucleus Grasping Forcep	203
Allen Intestinal Clamp	611
Allis Intestinal & Tissue Grasping Forcep	606-607
Allis-Adair Intestinal & Tissue Grasping Forcep	606
Allis-Baby Intestinal & Tissue Grasping Forcep	606
Allport Wound Spreader	332
Alm Wound Spreader	332
Anaestophon Stethoscope	390
Anderson-Adson Self-Retaining Retractor	334
Anoscope	622
Anvil Nail Extracting Forcep	599
Arruga	
Capsule Forcep	203
Micro Needle Holder	439
Needle Holder	440, 457
Aston Facelift Scissor	48
Austin Micro Suturing Forcep	168

B

	Page
Babcock Intestinal & Tissue Grasping Forcep	608
Babinsky Percussion Hammer	388
Backhaus Towel Clamp	275
Bainbridge Haemostatic Forcep	245
Baird Chalazion Forep	208
Bakes Gall Duct Dilators	637-638
Bakes Gall Stone Forcep	638
Balfour Modell USA Retractor	362
Balfour Self Retaining Retractor	360-362
Balfour-Baby Self Retaining Retractor	360
Bandage Scissor	93
Baron-Schuknecht Suction Tube	403
Barr Rectal Speculum	620
Barraquer	
Blade Breaker	25
Cilia Forcep	187
Iris Scissor	99
Micro Needle Holder	442-444, 455
Barraquer-Troutman Micro Needle Holder	441-442
Barre	
Dissecting & Ligature Forcep	261
Vascular Scissor	67
Baumgartner Wire Twisting Forcep	512
Battery Operated Drill	491
Battery Operated Sagittal Saw	494
Battery Operated Sternum Saw	494
Bechert Lens Holding Forcep	205
Beckmann Self Retaining Retractor	343
Beckmann-Adson Self Retaining Retractor	344-345
Beckmann-Eaton Self Retaining Retractor	346
Bed Pan	655
Beebee Crown Scissor	90-91
Beer Cilia Forcep	186
Beeson Plaster Spreader	486
Bengolea Haemostatic Forcep	246
Bennett Bone Lever	571
Benson Pylorus Spreader	614
Bergh Cilia Forcep	186
Bergmann	
Bandage Scissor	94
Bone Mallet	538
Operating Knife	16
Sponge Holding Forcep	285
Berke Ptosis Forcep	207
Berkeley-Bonney Hysterectomy Forcep	270
Bernhard Towel Clamp	276

Alphabetical Index

B

	Page
Berry Wire Twisting Forcep	512
Beyer Bone Rongeur	590
Biemer	
Clip Applying Forcep	216
Vein Scissor	107
Vessel Clip	216
Biemer-Mueller Nerve Approximator	217
Bier Amputation Saw	490
Bier Saw Blade	490
Bircher-Ganske Bone Holding Forcep	582
Birkett Haemostatic Forcep	245
Bishop-Harmon	
Dressing Forcep	195
Iris Forcep	194
Blaydes Lens Holding Forcep	206
Blond Proctoscope	623-625
Blount Knee Retractor	573
Blue Rectal Aspiration Cannula	630
Blumenthal Bone Rongeur	588-589
Bohler	
Bone Cutting Forcep	595
Bone Rongeur	590
Extension Bows	505
Boley Caliper	396
Bonaccolto Conjunctival Forcep	201
Bone Chisel	518, 520, 530
Bone Curette	549-550
Bone File	535
Bone Gouge	520, 531, 532
Bone Holding Forcep	580-581, 585
Bone Lever	566-567, 570
Bone Mallet	538, 540-542
Bone Osteotome	519
Bone Reamer	494-495
Bone Repositioning Forcep	579-581
Bone Tamper	536
Bonn	
Corneal Forcep	192
Iris Scissor	78-79
Bonner-Modell Dissecting Forcep	156
Bonney	
Dissecting Forcep	162, 210
Dressing Forcep	148
Borchardt Burr	503
Borchardt Flat Trephine	500
Borchardt Twist Drill	499-503

B

	Page
Bose Fat Spreader	331
Botvin Iris Forcep	189
Bowel Dissecting Scissor	88
Bowl	648-649, 651
Bowman Probe	381
Boys-Allis Intestinal & Tissue Grasping Forcep	607
Bozemann	
Gynecological Scissor	39
Knot Tier	481
Needle Holder	461
Sponge Holding Forcep	284-285
Bozemann-Douglas Sponge Holding Forcep	285
Brand Tendon Tunnelling Forcep	577
Braun-Stadler Episiotomy Scissor	73
Bridge Haemostatic Forcep	248
Bristow Bone Lever	572
Brodie Butterfly Probe	380
Brom Vein Hook	300
Brompton Tube Milking Roller	278
Brophy	
Dissecting Forcep	156
Dressing Forcep	147
Brown Needle Holder	430
Brunetti Post Mortem Chisel	518
Brunner	
Intestinal Clamp	613, 617
Ligature Conductor	479
Ligature Needle	478
Retractor	314
Bruns	
Bone Curettes	544, 545
Plaster of Paris Shear	96
Bryant Dressing Forcep	281
Buchs	
Periosteal Elevator	556
Retractor	312
Buck	
Percussion Hammer	388
Stitch Scissor	89
Buckley Wound Spreader	332
Bunnell	
Hand Drill	504
Tendon Passer	577
Tendon Stripper	575
Buratto	
IOL Inserting Forcep	205

Alphabetical Index

B

	Page
Buratto	
LASIK Flap Forcep	197
Burke Hysterectomy Forcep	271
Busch Umbilical Cord Scissor	74
Butterfly Probe	380
Byrd Suction Tube	410

C

Cairns Haemostatic Forcep	241-242
Caplan Septum Scissor	70
Carrel Haemostatic Forcep	228
Carroll	
Finger Goniometer	394
Tendon Tunnelling Forcep	578
Caspar	
Bone Curette	546
Bone Tamper	536
Ligature Adjuster	481
Periosteal Elevator	555
Retractor	313, 372-374
Scalpel Handle	9
Castroviejo	
Blade Breaker	25
Caliper	396-397
Corneoscleral Scissor	99
Keratoplasty Scissor	101
Micro Needle Holder	436-440, 447-449, 454-457
Suture Tying Forcep	193-194
Universal Corneal Scissor	101
Castroviejo-Colibri Corneal Forcep	191
Castroviejo-Epker Corneal Forcep	396
Catheter Introducer	643
Catlin Amputation Knife	20
Cawthorne Probe	378
Chadwick Delicate Scissor	84
Chandler Bone Lever	572
Chaput Haemostatic Forcep	225
Charnley	
Dissecting Forcep	165
Retractor	364
Charriere Amputation Saw	490-491
Charriere Saw Blade	490
Cheron Dressing Forcep	284

C

	Page
Childe Approximation Forcep	482
Cinelli Nasal Scissor	49
Clar Head Light	391
Claus Van Eicken Ligature Needle	471
Clayman Lens Holding Forcep	206
Cleveland	
Bone Cutting Forcep	595
Bone Rongeur	587
Clip Applying Forcep	219
Cloward	
Bone Gouge	528
Bone Osteotome	527
Lamina Spreader	374-375
Retractor	367-368
Cobb	
Bone Curette	547
Bone Gouge	531-532
Periosteal Elevator	563
Cogswell Suction Tube	410
Colibri Corneal Forcep	190
Collar Haemostatic Forcep	239
Collier Needle Holder	428
Collin	
Bone Mallet	537
Clip Applying Forcep	483
Dressing Forcep	284
Dynamometer	395
Organ Grasping Forcep	226
Scalpel Handle	4
Self-Retaining Retractor	348-352
Tumor Grasping Forcep	226
Collin-Baby Self-Retaining Retractor	348
Collin-Duval Intestinal Forcep	163
Collin-Hartmann Retractor	327
Collingwood-Stewart Hernia Ring Forcep	646
Combi Wire Twisting & Cutting Forcep	512-515
Conical Burr	497, 501-502
Converse	
Alar Hook	293
Nasal Scissor	72
Needle Holder	428, 459
Converse (Graefe) Nasal Scissor	72
Cooley	
Atrauma Dissecting Forcep	183
Dressing Forcep	148
Retractor	323

Alphabetical Index

C

	Page
Cooley	
Suction Tube	407-408
Vascular Scissor	67
Cooper Ligature Needle	472
Corwin Wire Twisting Forcep	512
Coryllos Retractor	314
Cottle	
Alar Hook	294
Bone Mallet	538
Bulldog Scissor	83
Lid Retractor	296
Nasal Hook	290
Nasal Scissor	71, 133
Periosteal Elevator	554
Cottle-Kazanjian Bone Cutting Forcep	594
Cottle-Masing Plastic Surgery Scissor	49
Cotton Applicator	385
Coupland Suction Tube	409
Crafoord Haemostatic Forcep	247
Crafoord-Sellors Haemostatic Forcep	248
Cranny-Ryall Retractor	330
Crile	
Haemostatic Forcep	233-234
Needle Holder	435
Nerve Hook	291
Crile-Murray Needle Holder	430
Crile-Rankin Haemostatic Forcep	234
Crile-Wood Needle Holder	430, 458, 460
Cushing	
Dissecting Forcep	156
Dressing Forcep	146, 212
Flat Trephine	497
Nerve Hook	291
Periosteal Elevator	557
Retractor	299-300
Cushing-Kocher Retractor	310
Cushing-Taylor Dressing Forcep	212
Czerny	
Rectal Speculum	618
Retractor	329

D

	Page
Dahmen	
Bone Gouge	534
Bone Osteotome	533
Dandy Haemostatic Forcep	241
Dandy-Mosquito Haemostatic Forcep	241
Daubenspeck Bone Curette	548
Davidson Scapula Retractor	314
De Martel-Wolfson Clamp Holder	614
De Martel-Wolfson Closing Forcep	614
De Martel-Wolfson Intestinal Clamp	614
Dean Tonsil Scissor	70, 140
Deaver	
Operating Scissor	31
Retractor	320-322
DeBakey	
Arteriotomy Scissor	59
Atrauma Dissecting Forcep	181-183, 213-214
Needle Holder	454, 462
Offset Scissor	66
Suction Tube	408
Vascular Scissor	60, 138
DeBakey-Diethrich Atrauma Bulldog Clamp	222
DeBakey-Hess Atrauma Bulldog Clamp	223
Deep Saw Blade	488
Dejerine Percussion Hammer	388
Delicate Gum Scissor	77
Delicate Scissor	84
Demel	
Wire Guide	504
Wire Tightener	505
Dennis-Browne	
Intestinal Forcep	163
Retractor	366-367
Denture Cup	654
Derf Needle Holder	428, 458
Dermal Punch	602
Dermatoscope	394
Deschamps Ligature Needle	472-477
Desjardins	
Bile Duct Clamp	264
Gall Stone Forcep	639
Desmarres	
Chalazion Forcep	209
Entropion Forcep	209
Lid Retractor	296
Dick Atrauma Vaginal Clamp	267

Alphabetical Index

D

	Page
Dieffenbach	
Bulldog Clamp	220
Operating Knife	14-16
Diethrich	
Bulldog Clamp	221
Micro Needle Holder	457
Vascular Scissor	60
Diethrich-Potts Vascular Scissor	63-65
Diethrich-Salyer Cleft Palate Scissor	60
Dingmann Cartilage Seizing Forcep	582
Diplomat Manometer	390
Dissecting & Ligature Forcep	250
Dissecting Forcep	155, 157
Dissecting Hook	311
Dissecting Scissor	57
Dockhorn Retractor	313
Dodick	
IOL Folding Forcep	204
Nucleus Cracker	203
Douglas Cilia Forcep	186
Downes Lid Clamp	208
Doyen	
Bone Mallet	537
Butterfly Probe	380
Conical Burr	502
Cylindrical Burr	502
Gynecological Scissor	37
Intestinal Clamp	610, 615-616
Needle Holder	429
Retractor	317
Rib Raspatory	562
Spherical Burr	501-502
Towel Clamp	274
Doyen-Baby Intestinal Clamp	609, 615
Doyen-Stille Retractor	318
Dressing Forcep	147-148
Dressing Jar	653
Drill Handle	495
Dunhill Haemostatic Forcep	240, 242
Duplay Sponge Holding Forcep	283
Duplex Stethoscope	390
Duplex-Baby Stethoscope	389
Durante Dissecting Forcep	162
Durham Retractor	312
Duval Intestinal & Tissue Grasping Forcep	163, 609

E

	Page
Echlin Bone Rongeur	592
EENT Diagnostic Set	393
Eiselberg Stitch Scissor	90
Elsaesser Nephrectomy Forcep	637
Elschnig Fixation Forcep	195
Emmet Dressing Forcep	284
Engel Plaster Saw	486
Enterotomy Scissor	87-88
Enucleation Scissor	83
Erhardt Lid Forcep	208
Ernest Nucleus Cracker	203
Esmarch	
Bandage Scissor	95
Plaster of Paris Shear	485
Extension Bows	506

F

Farabeuf	
Bone Holding Forcep	584
Periosteal Elevator	558
Retractor	328
Farrell Cotton Applicator	384
Fat Spreader	332
Faulkner Lens Holding Forcep	205
Faure Peritoneum Forcep	274
Favaloro Offset Scissor	66
Fechtner Conjunctival Forcep	191
Fehland Sigmoid Anastomosis Clamp	618
Feilchenfeld Splinter Forcep	185
Feldheim Tourniquet	597
Female Catheter	643
Female Urinal	656
Fergusson	
Angiotribe	272
Bone Holding Forcep	581
Suction Tube	401
Ferris-Smith Dissecting Forcep	162, 213
Fickling Haemostatic Forcep	244-245
Filiform Urethral Sound	644
Fine	
Dissecting Forcep	150
Dressing Forcep	143
Micro Scissor	103

Alphabetical Index

F

	Page
Fine	
Operating Scissor	76
Suture Tying Forcep	200
Stitch Scissor	103
Finger Ring Saw	598
Finochietto	
Dissecting & Ligature Forcep	262
Needle Holder	433, 462
Finsen Wound Spreader	330-331
Finsen-Martin Wound Spreader	331
Finsterer Suction Tube	408
Fischer Tendon Stripper	576
Flat Burr	503
Flat Nose Plier	513-515
Foerster Sponge Holding Forcep	286-287
Fomon Nasal Scissor	50, 71, 133
Ford Dixon Hemorrhoidal Ligator	631
Foreign Body Forcep	202
Foster-Gillies Needle Holder	465
Fowler Tonsil Knife	22
Fox Lupus Curette	601
Francis Chalazion Forcep	209
Fraser-Kelly Haemostatic Forcep	239
Frazier	
Delicate Hook	289
Suction Tube	401
Freeman-Kaye Facelift Scissor	135
Freer Mucus Hook	293
Friedmann	
Bone Rongeur	586-587
Retractor	346
Fritsch Retractor	318
Frosch Bone Holding Forcep	583
Frykholm Bone Rongeur	593

G

Gardner Bone Chisel	519
Gelpi Self Retaining Retractor	347
Gemini Dissecting & Ligature Forcep	257
Gemini, Mini Dissecting & Ligature Forcep	257
Gerald	
Dissecting Forcep	155, 210
Dressing Forcep	146

G

	Page
Gerald	
Micro Forcep	180
Micro Ring Forcep	180
Micro Suturing Forcep	181
Gerald-DeBakey Micro Atrauma Forcep	180
Gerl Suture Tying Forcep	200-201
Gerster Traction Bar	511
Gerster-Lowman Bone Holding Clamp	511
Gerzog Bone Mallet	537
Gil-Vernet Retractor	300
Gillies	
Dissecting Forcep	154, 210
Dressing Forcep	147
Needle Holder	434, 465
Skin Hook	289
Gillies-Mini Needle Holder	465
Gills Capsulotomy Scissor	106
Gills-Colibri Corneal Forcep	189
Gills-Vannas	
Capsulotomy Scissor	104
Micro Scissor	105
Girard Corneoscleral Forcep	194
Glover, Mini Bulldog Clamp	223-224
Goelet Retractor	330
Gold Punctal Plug Forcep	202
Goldman-Fox Gum Scissor	74-75, 137
Goligher Retractor	363
Gomco Circumcision Clamp	645
Good Tonsil Scissor	71
Gorney Facelift Scissor	48, 134-135
Gosset Retractor	359
Gosset-Baby Retractor	358
Gradle Cilia Forcep	201
Graduated Measure	649-650
Graduated Triangular Basin	656
Graefe	
Delicate Hook	289
Eye Dissecting Forcep	188-189
Eye Dressing Forcep	188
Fixation Forcep	195
Nerve Hook	291
Gray Dissecting & Ligature Forcep	265
Greene Retractor	312
Gregory Facelift Scissor	134
Grey-Turner Haemostatic Forcep	241
Gross-Maier Sponge Holding Forcep	282-283

Alphabetical Index

G

	Page
Guthrie Skin Retractor	292
Guyon	
Kidney Pedicle Clamp	263-264
Urethral Sound	642-643
Gwilliam Hysterectomy Forcep	270

H

Haberer Intestinal Clamp	613
Haemostatic Forcep	228
Hajek	
Bone Mallet	537
Retractor	329
Halle Bone Curette	548
Halsey Needle Holder	428-429, 459
Halsted-Mosquito Haemostatic Forcep	228-231
Hand Immobilizer	597
Harms Suture Tying Forcep	200
Harms-Colibri Corneal Forcep	190-191
Harrington Retractor	320
Harris Chuck	492
Hartmann	
Bone Rongeur	588
Cotton Applicator	385
Haemostatic Forcep	227-228
Harvey Wire Cutting Scissor	90
Harvey-Jackson Self Retaining Retractor	344
Hatfield Bone Curette	547
Hayes Sigmoid Anastomosis Clamp	617
Head Light	392
Heaney	
Hysterectomy Forcep	266-268
Needle Holder	432, 461
Heaney (Rogers) Hysterectomy Forcep	268
Heaney-Ballentine Hysterectomy Forcep	266
Heaney-Razek Hysterectomy Forcep	266
Heath Bone Mallet	539
Heberer Abdominal Spatula	326
Hegar Needle Holder	460
Hegar-Baumgartner Needle Holder	429, 459
Hegar-Vascular Needle Holder	464
Hegenbarth Clip Applying Forcep	482
Heifetz Tumor Grasping Forcep	166
Heiming Kidney Stone Forcep	637

H

	Page
Heiss Haemostatic Forcep	249
Helveston Suture Tying Forcep	200
Hemingway Bone Curette	550-551
Henley Retractor	354
Hennig Plaster Spreader	486
Hepp-Scheidel Micro Needle Holder	454, 457
Herbert Bone Mallet	542
Herrick Kidney Pedicle Clamp	264
Heygroves Bone Holding Forcep	583
Heymann Nasal Scissor	72
Heywood-Smith Sponge Holding Forcep	285
Hibbs	
Bone Chisel	526
Bone Gouge	527
Bone Osteotome	526
Knee Retractor	574
Hirschman Anoscope	621
Hoer Periosteal Elevator	557
Hoesel	
Retractor	319
Needle Holder	435
Hoffer-McPherson Tissue Forcep	193
Hoffmann Tubing Clamp	279
Hohmann Bone Lever	567-569
Hohmann-Aldinger Bone Lever	570
Hohmann-Mini Bone Lever	566
Hoke Osteotome	526
Holzbach Hysterectomy Forcep	269
Hopkins Plaster Knife	485
Hoskins Tissue Forcep	191
House Suction Tube	403-404
Hudson	
Chuck	492
Hand Drill	497
Humby Skin Graft Knife	23
Hunt	
Chalazion Forcep	208
Tumor Grasping Forcep	166
Hunter Splinter Forcep	185
Hurd Ligature Needle	477
Hypodermic Needle	410
Hypodermic Syringe	414

Alphabetical Index

I	Page
Ideal Finger Nail Drill	597
Incision Scissor	30
Inge Lamina Spreader	375
Instrument Box	652-653
Instrument Tray	650-651
Interosseous Knife	20
Iris	
Micro Scissor	103
Scissor	78-80, 137-139
Israel Retractor	306
Ives-Fansler Anoscope	622
Iwanson Clipper	397

J	Page
Jaboma Micro Scissor	121-122
Jackson-Burrows	
Dissecting Forcep	165
Self-Retaining Retractor	348
Jacobs Chuck	491, 499
Jacobson	
Haemostatic Forcep	240
Micro Needle Holder	438, 456
Micro Scissor	108, 119
Jaffe	
Capsulorhexis Forcep	198
Stitch Scissor	102
Suture Tying Forcep	198-199
Utility Forcep	202
Jameson	
Caliper	394
Dissecting Scissor	58
Muscle Forcep	206-207
Needle Holder	432
Jameson-Werber Dissecting Scissor	58
Janet Syringe	414
Jansen	
Bone Curette	550
Bone Rongeur	588
Periosteal Elevator	556
Self-Retaining Retractor	333
Jefferson Self-Retaining Retractor	340
Jeweller Forcep	157-159
Jobson-Horne Ear Probe	385

J	Page
John-Hopkins Bulldog Clamp	221
John-Hopkins Clip Applying Forcep	221
Johnson Needle Holder	433
Joll (Friedman) Self-Retaining Retractor	346
Jones Towel Clamp	274
Jonesco Ligature Needle	471
Joseph	
Dissecting Scissor	40-41, 129
Mucus Hook	290, 293
Judd-Allis Intestinal & Tissue Grasping Forcep	607
Judd-Masson Retractor	356

K	Page
Kader Abdominal Retractor	325
Kahre-Williger Periosteal Elevator	561
Kalt Micro Needle Holder	439
Kantrowitz Dissecting & Ligature Forcep	261
Karp Aorta Punch	25
Katsch Comedone Extractor	603
Katzin Corneal Transplant Scissor	100
Kaye	
Facelift Hook	602
Facelift Scissor	47, 134
Scalpel Handle	5
Kaye-Millard Retractor	301
Kelly	
Dissecting & Ligature Forcep	255-256
Dissecting Scissor	39-40, 139
Haemostatic Forcep	232-233
Proctoscope	622
Retractor	316, 324
Sphincteroscope	625
Kelly-Rankin Haemostatic Forcep	233
Kelman-McPherson	
Tissue Forcep	193
Suture Tying Forcep	197
Kern Bone Holding	583
Kerpel Bone Curette	551
Key Periosteal Elevator	556
Keyes Dermal Punch	602
Kidney Dish	655
Kieback	
Dissecting & Ligature Forcep	258

Alphabetical Index

K

	Page
Kieback	
Hysterectomy Forcep	270
Parametrium Scissor	39
Killian	
Bone Shear	69
Probe	379
Kilner	
Alar Hook	293
Dissecting Scissor	56, 83, 139
Needle Holder	429, 458
Skin Hook	289
Kirsch Retractor	310
Kirschner	
Extension Bows	506
Ligature Conductor	479
Ligature Needle	478
Retractor	365-366
Wire Drill	507-510
Klapp Retractor	301
Kleinert-Kutz	
Delicate Hook	289
Tendon Holding Forcep	578
Klinikum Berlin Tubing Clamp	277
Klinkenberg-Loth Vascular Scissor	68
Knapp Fine Wound Retractor	292
Knowles Bandage Scissor	93
Knutson Urethrography Instrument	644
Kocher	
Haemostatic Forcep	236-237
Intestinal Clamp	611, 616-617
Ligature Needle	472
Retractor	304, 308, 311, 318
Kocher-Baby Intestinal Clamp	610-611
Kocher-Langenbeck Retractor	309
Kocher-Nippon Haemostatic Forcep	237-238
Kocher Delicate Haemostatic Forcep	238-239
Koenig	
Ligature Conductor	480
Periosteal Elevator	552
Retractor	310
Koerte Retractor	305-306, 323
Korenlein Haemostatic Forcep	225
Kraemer	
Periosteal Elevator	555-556
Retractor	313
Kraff Capsule Tag Forcep	198

K

	Page
Kratz Lens Holding Forcep	206
Kronecker Ligature Needle	472
Kummel	
Abdominal Spatula	324
Retractor	323
Kurstin Flap Stretching Forcep	197

L

La Grange Gum Scissor	76
Lagueu Retractor	356
Lahey	
Bile Duct Clamp	262
Dissecting & Ligature Forcep	261
Retractor	308
Lahey (Sweet) Bile Duct Clamp	262
Lambert Chalazion Forcep	208
Lambotte	
Bone Holding Forcep	584
Bone Osteotome	523
Periosteal Elevator	563
Lambotte-Mini Bone Osteotome	522-523
Landolt	
Dissecting Suction Tube	405
Periosteal Elevator	555
Scalpel Handle	9-10
Lane	
Bone Holding Forcep	585
Bone Lever	572
Dissecting Forcep	164
Intestinal Clamp	612-613
Retractor	329
Towel Clamp	277
Lane-Terthowan Bone Lever	572
Lange-Hohmann Bone Lever	569
Langenbeck	
Amputation Saw	490
Bone Holding Forcep	581
Flap Knife	20
Needle Holder	435, 467
Periosteal Elevator	557-558, 564
Resection Knife	21
Retractor	307-308
Langenbeck-Green Retractor	297

Alphabetical Index

L

	Page
Langenbeck-Mini Retractor	297
Lawrence	
Dissecting & Ligature Forcep	256
Needle Holder	430
Lazar Micro Suturing Forcep	167
Leksell-Stille Bone Rongeur	592
Lempert Bone Rongeur	588
Lerche Dissecting Forcep	152
Leriche	
Haemostatic Forcep	232
Retractor	322
Lewin Bone Repositioning Forcep	580
Lexer	
Dissecting Scissor	48-49, 129-130
Bone Chisel	529-530
Bone Gouge	528, 530
Bone Osteotome	529-530
Lexer-Baby Dissecting Scissor	50
Lexer-Fine Dissecting Scissor	50-51
Lexer-Mini	
Bone Gouge	529
Bone Osteotome	528
Lichtenberg Needle Holder	434, 466
Lichtwitz Antrum Puncture Needle	412
Lid Retractor	296
Ligature Adjuster	481
Ligature Conductor	479
Ligature Needle	471, 478
Lister	
Bandage Scissor	94, 140
Sinus Forcep	281
Lister (Eccentric) Bandage Scissor	94
Liston	
Amputation Knife	19
Bone Cutting Forcep	594
Liston-Key Bone Cutting Forcep	596
Littauer	
Cilia Forcep	186
Stitch Scissor	90
Little Retractor	308
Littler Dissecting Scissor	83
Littlewood Intestinal & Tissue Grasping Forcep	608
Livernois	
IOL Folding Forcep	204
IOL Holding Forcep	204-205
Livernois-McDonald IOL Inserting Forcep	205

L

	Page
Lloyd-Davies (Goligher) Rectal Scissor	88
Lockhart-Mummery Fistula Probe	381-382
Locklin Gum Scissor	77, 140
Lockwood Intestinal & Tissue Grasping Forcep	607
Logan Wound Spreader	331
Lorenz Bandage Scissor	93
Lorna Towel Clamp	276
Loute Wire Tightener	505
Lovelace Haemostatic Forcep	242
Lucae Bone Mallet	538
Lucas Bone Curette	551
Luer Bone Rongeur	589
Luer Suction Tube	404
Luer-Koerte Gall Stone Scoop	640

M

M.G. Hospital Needle Holder	431
Magill Catheter Introducing Forcep	418
Magnifying Glass	392
Maingot Hysterectomy Forcep	265
Male Urinal	656
Malleolar Forcep	580
Manhattan Eye & Ear Fixation Forcep	195
Manometer	390
Marquard Bone Rongeur	591
Martel-Rees Facelift Forcep	227
Martin	
Abdominal Spatula	326
Cartilage Seizing Forcep	583
Dressing Forcep	281-282
Finger Ring Saw	598
Hand Drill	498
Ligature Needle	478
Needle Holder	463
Plaster Knife	485
Retractor	313
Self-Retaining Retractor	346
Martin-Cushing Periosteal Elevator	557
Martin-Fuchsig Haemostatic Forcep	243
Martin-Jones Towel Clamp	275
Martin-Langenbeck Periosteal Elevator	564
Martini Needle Holder	464

Alphabetical Index

M

	Page
Masing	
Cartilage Slitting Knife	22
Lid Retractor	296
Masson Needle Holder	432, 461
Masson-Luethy Needle Holder	432
Mathieu	
Foreign Body Forcep	645
Needle Holder	434, 465-466
Rectal Speculum	620
Retractor	329
Mayfield Bone Rongeur	590
Mayo	
Common Duct Probe	379
Dissecting Scissor	31-32, 124-125
Mayo (Russian) Dissecting Forcep	162
Mayo-Bakes Gall Stone Forcep	638-639
Mayo-Harrington Dissecting Scissor	33
Mayo-Hegar Needle Holder	431, 460
Mayo-Lexer Dissecting Scissor	130
Mayo-Noble Dissecting Scissor	35-36
Mayo-Robson Intestinal Clamp	610, 616
Mayo-Stille Dissecting Scissor	34-35, 125-126
McDonald Periosteal Elevator	565
McGivney Hemorrhoidal Ligator	630-631
McIndoe	
Cartilage Scissor	47
Dissecting Forcep	156
Dressing Forcep	144, 210
Wound Retractor	293
McIntosh Laryngoscope	419-421, 424
McIntosh-Baby Laryngoscope	419
McKenzie Burr	498
McKissock Periosteal Elevator	555
McPherson	
Micro Needle Holder	435-436
Suture Tying Forcep	192, 196
McPherson-Vannas Iris Scissor	105
McPherson-Westcott	
Conjunctival Scissor	101
Stitch Scissor	102
McQuigg-Mixter Dissecting & Ligature Forcep	260
Mead	
Bone Mallet	539
Bone Rongeur	587
Periosteal Elevator	553
Measuring Caliper	396

M

	Page
Measuring Tape	397
Medicine Cup	654
Medicine Spoon	654
Meeker Dissecting & Ligature Forcep	256
Mendez Multipurpose LASIK Forcep	197
Menghini Liver Puncture Needle	412
Meniscus Knife	574
Metal Cup	654
Metal Jar	652
Methot Cotton Dispenser	657
Metzenbaum	
Dissecting Scissor	41-44, 46, 126-128
Needle Holder	431
Nerve Dissecting Scissor	47
Metzenbaum-Thorek Dissecting Scissor	128
Metzenbaum-Fine Delicate Dissecting Scissor	51-54, 130-133
Metzenbaum-Lahey Dissecting Forcep	132-133
Metzenbaum-Nelson Dissecting Scissor	45-46
Meyerding Retractor	298, 317
Michel Clip Applying & Removing Forcep	482-483
Michel Clip Applying Forcep	482
Michel Suture Clips	483
Micro Atrauma Forcep	174, 179-180
Micro Coronary Scissor	111-113, 115-116
Micro Dissecting Forcep	171-172
Micro Dissecting Scissor	108
Micro Dressing Forcep	169-170, 181
Micro Elevator	564
Micro Mosquito Haemostatic Forcep	229-230
Micro Needle Holder	438, 440-441, 445-447, 449-453, 456
Micro Pierce Forcep	160-161, 175-177
Micro Ring Forcep	173, 175, 177-179
Micro Scalpel Blade	10-11
Micro Scissor	98, 107-109, 114, 117-121
Micro Suturing Forcep	168-169, 174-176, 178 -179
Micro Vascular Needle Holder	464
Micro Vessel Dilator	160-161, 175-177
Middeldorf Retractor	312
Mikulicz	
Peritoneum Forcep	273
Retractor	324
Mikulicz-Baby Peritoneum Forcep	272
Miller Laryngoscope	418-419, 422, 425
Millesi Micro Scissor	110
Milligan Self-Retaining Retractor	342

Alphabetical Index

M

	Page
Millin	
Capsule Forcep	641
Ligature Holding Forcep	481
Retractor	355-356
Mixing Bowl	649
Mixer	
Dissecting & Ligature Forcep	259
Gall Stone Forcep	639
Mixer-Baby Dissecting & Ligature Forcep	258-259
Mixer-O'Shaughnessy Dissecting & Ligature Forcep	260
Mock Heparin Flushing Needle	414
Modell Wien Ligature Catcher	481
Modell. USA	
Bone Curette	547-548
Dissecting Forcep	151
Dressing Forcep	143
Umbilical Cord Scissor	73
Moeltgen Flexometer	395
Mogen Circumcision Clamp	645
Mohr Pinchcocks	279
Moldestad Vessel Hook	295
Mollison Self-Retaining Retractor	340-341
Molt Bone Curette	552-553
Molt Periosteal Elevator	553
Monocorps Miliium Knife	601
Moore Hand Drill	498
Moorfield Conjunctival Forcep	201
Morgan Proctoscope	625
Morris Retractor	316
Moynihan Hysterectomy Forcep	271
Muehling Bone Shear	70
Mueller	
Nerve Approximator	218
Rectal Scissor	89
Murphy Retractor	305
Murphy-Lane Bone Lever	571
Myrtle Leaf Probe	378

N

Nabatoff Vein Probe	382-383
Nail Scissor	91-92
Naunton-Morgan Needle Holder	462
Needle Holder	462

N

	Page
Neff Meniscus Knife	575
Negus Haemostatic Forcep	243-244
Neivert Needle Holder	429
Nelaton Butterfly Probe	380
Nelson	
Dissecting Forcep	163
Trocar	399
Nerve Approximator	218-219
Nerve Dissecting Scissor	57, 84
Nissen	
Bile Duct Clamp	264
Haemostatic Forcep	243
Non Perforating Towel Clamp	276
Norfolk-Norwich Self-Retaining Retractor	335
Northbent Stitch Scissor	89
Norwood Rectal Snare	629
Noyes Iris Scissor	97-98
Nuboer Suction Tube	409
Nugent Utility Forcep	201-202
Nussbaum Intestinal Clamp	612

O

O'Connell Periosteal Elevator	566
O'Connor Skin Hook	290
O'Sullivan-O'Connor Retractor	364
Ochsner	
Dressing Forcep	148
Gall Stone Probe	379
Trocar	399
Ochsner-Kocher Haemostatic Forcep	235-236
Oehler Dissecting Forcep	213
Olivecrona	
Trigeminal Knife	21
Trigeminal Scissor	68
Ollier Retractor	305
Olsen-Hegar Needle Holder	433, 465
Omberdanne Bone Mallet	539
Operating	
Knife	16-18
Loupe	392
Scissor	27-30, 123-124
Ophthalmoscope	393-394
Organ Grasping Forcep	226

Alphabetical Index

O

	Page
Oscillating Sagittal Saw	493
Osher Iris Forcep	202
Otis Urethrotome	644
Otoscope	393-394
Overholt Dissecting & Ligature Forcep	254
Overholt-Baby Dissecting & Ligature Forcep	251
Overholt-Fine Dissecting & Ligature Forcep	254
Overholt-Geissendoerfer Dissecting & Ligature Forcep	252-253
Overholt-Martin Dissecting & Ligature Forcep	250
Overholt-Mini Dissecting & Ligature Forcep	255
Overholt-Mixter Dissecting & Ligature Forcep	251

P

Parametrium Hysterectomy Scissor	136
Parker Retractor	328
Parker-Langenbeck (US Army) Retractor	329
Parker-Mott Retractor	328
Parks Rectal Speculum	620
Partsch	
Bone Chisel	520-521
Bone Gouge	521
Bone Mallet	540
Periosteal Elevator	552
Partsch Mod. Lange	552
Passow Bone Tamper	536
Patella Forcep	580
Payr	
Intestinal Clamp	612
Ligature Conductor	480
Payr-Baby Intestinal Clamp	611
Pean Delicate Haemostatic Forcep	238
Pean Haemostatic Forcep	224
Pean-Nippon Haemostatic Forcep	237
Peck-Joseph Facelift Scissor	55-56
Peers-Bretram Towel Clamp	277
Peet Splinter Forcep	187
Pelkmann Foreign Body Forcep	283
Pennington Organ Grasping Forcep	226
Pennybaker Periosteal Elevator	556, 566
Percy Amputation Shield	586
Periosteal Elevator	559-562
Perkins Self-Retaining Retractor	339-340
Perthes Bone Reamer	494

N

	Page
Phalangeal Knife	20
Phaneuf Hysterectomy Forcep	265
Pierce-Colibri Corneal Forcep	190
Pinard Stethoscope	389
Placenta Pan	656
Plaster of Paris Shear	96
Plaster Saw	487
Plester Self-Retaining Retractor	341-342
Polloson Retractor	319
Poole Suction Tube	407
Poole-Baby Suction Tube	407
Post Mortem Chisel	518
Post Mortem Hammer	518
Potts	
Dissecting Scissor	59
Micro Scissor	120
Potts-De Martel Vascular Scissor	66
Potts-Smith	
Dissecting Forcep	156
Dressing Forcep	146, 212
Vascular Scissor	60-62, 67
Pratt	
Fistula Probe	382
Haemostatic Forcep	227
Rectal Speculum	618
Presbyterian Tubing Clamp	278
Pressofix Tourniquet	391
Prince Tonsil Scissor	70
Proctoscope	623
Probe	377-379
Prostate Retractor	326
Providence-Hospital Haemostatic Forcep	231
Pudendus Anaesthesia Needle	411
Putti Bone Rasp	534-535

Q

Quattro (Mod. USA) Plaster Spreader	486
Quimby Delicate Scissor	84
Quinke Lumbar Puncture Needle	411

Alphabetical Index

R

	Page
Rabiner Percussion Hammer	389
Rachietome	518
Radolf Nail Extracting Forcep	599
Ragnell (Kilner) Dissecting Scissor	56, 139
Ragnell-Davis Retractor	298
Ralk	
Hand Drill	504
Splinter Forcep	187-188
Ramley Sponge Holding Forcep	287
Ramsey	
Dissecting Forcep	164
Dressing Forcep	148
Randall Kidney Stone Forcep	635-636
Razor Knife	22-23
Record-Arkansas Sharpening Stone	23
Rectal Scissor	88
Recto-Proctoscope	626-629
Rectoscope	626
Redon Guide Needle	415-416
Rees Facelift Scissor	134
Reill	
Bone Repositioning Forcep	579
Micro Needle Holder	445
Reiner Plaster Knife	485
Resano	
Cartilage Scissor	41
Sigmoid Anastomosis Clamp	618
Resection Knife	20
Reverdin	
Abdominal Spatula	325
Ligature Needle	467-469
Reynolds Dissecting Scissor	57-58
Ribbon	
Grade Scissor	87
Iris Scissor	85
Kaye Facelift Scissor	87
Salyer Scissor	85
Stevens Tenotomy Scissor	86-87
Strabismus Scissor	86
Ricard Retractor	352-353
Richardson Retractor	315
Richardson-Eastman Retractor	315
Richter Clip Applying Forcep	483
Roberts	
Haemostatic Forcep	247
Periosteal Elevator	554

R

	Page
Robin Towel Clamp	275
Rochester-Carmalt Haemostatic Forcep	244
Rochester-Ochsner Haemostatic Forcep	236
Rochester-Pean Haemostatic Forcep	235
Roeder Towel Clamp	276
Roettgen-Ruskin Bone Rongeur	592
Rollet Fine Wound Retractor	292
Roschke Anal Retractor	621
Rosenwasser Donor Lamella Inserting Forcep	204
Ross Aorta Retractor	319
Round Bowl	648, 651
Round Dish	649
Round Saw Blade	487
Roux Retractor	327-328
Roux-Baby Retractor	327
Roux-Mini Retractor	327
Rudd Hemorrhoidal Ligator	630
Ruler	397
Rumel Dissecting and Ligature Forcep	257
Ruskin Bone Rongeur	591
Ruskin-Liston Bone Cutting Forcep	595-596
Russian Modell Dissecting Forcep	161
Ryder Needle Holder	463
Ryder-Vascular Needle Holder	454, 463

S

Saalfeld Comedone Extractor	603
Sachse Meatotome	645
Salyer	
Bone Holding Forcep	582
Cleft Palate Scissor	54
Samii Tumor Grasping Forcep	165
Sanvenero Dissecting Scissor	55
Sarot	
Haemostatic Forcep	247
Needle Holder	432, 460
Satinsky Thoracic Scissor	59
Satterlee Amputation Saw	491
Satterlee Saw Blade	491
Sauer Fixation Forcep	195
Sauerbruch	
Bone Rongeur	594
Retractor	309, 315

Alphabetical Index

S

	Page
Scalp-Contour Self-Retaining Retractor	333-334
Scalpel Blade	5-8
Scalpel Handle	2-4, 9
Scalpel Blade Remover	8
Schaedel Towel Clamp	274
Schamberg Comedone Extractor	603
Schede Bone Curette	543
Scheibe (Collin) Organ Grasping Forcep	615
Schink Skin Graft Knife	24
Schink Skin Graft Knife Blade	24
Schmid Vessel Irrigation Cannula	414
Schmieden	
Ligature Conductor	479
Ligature Needle	470
Schmieden-Dick Ligature Needle	470
Schmieden-Payr Ligature Conductor	480
Schmieden-Taylor Dissecting Scissor	68
Schmidt Haemostatic Forcep	243
Schoenborn Retractor	311
Schumacher	
Bone Lever	571
Umbilical Cord Scissor	73
Schumacher (Wagner) Bone Lever	571
Scoville	
Bone Curette	545-546
Retractor	369-371
Scoville-Haverfield Retractor	369-370
Scoville-Richter Retractor	371
Scudder Intestinal Clamp	613, 617
Sedillot Periosteal Elevator	555, 559
Segment Saw Blade	487
Segond Hysterectomy Forcep	269
Segond-Landau Hysterectomy Forcep	269
Seiffert Probe	379
Seldin Periosteal Elevator	554
Selenius Meniscus Knife	575
Selman Dissecting Forcep	161
Semb	
Bone Cutting Forcep	597
Bone Holding Forcep	582-583
Bone Rongeur	591
Periosteal Elevator	563
Semken	
Dissecting Forcep	154, 210
Dressing Forcep	145
Micro Dissecting Forcep	211

S

	Page
Senn-Green Retractor	298
Senn-Miller Retractor	299
Sequestrum Bone Holding Forcep	581
Seutin Plaster of Paris Shear	95
Sewall Periosteal Elevator	553
Shaaf Splinter Forcep	185
Shea Vein Graft Scissor	56
Shepard Lens Holding Forcep	206
Silver	
Probe	378
Skin Graft Knife	24
Silver Skin Graft Knife Blade	25
Simon	
Bone Curette	546
Fistula Knife	21
Retractor	313
Sims	
Gynecological Scissor	36-38, 135
Rectal Speculum	619
Sims (Schulze-Bergmann) Rectal Speculum	619
Sims-Siebold Gynecological Scissor	37-38
Singley-Tuttle Dissecting Forcep	163
Skin Fixation Plate	24
Skin Graft Knife Blade	24
Skin Hook	290
Skull Breaker	517
Slender Pattern	
Dissecting Forcep	150
Dressing Forcep	142
Smillie	
Knee Retractor	572
Meniscus Knife	574
Smith (Mod. USA) Bandage Scissor	93
Smith-Peterson	
Bone Gouge	525
Bone Osteotome	524-525
Snyder-O.S.U Bone Gouge	519
Solution Bowl	649
Spencer Stitch Scissor	89
Spencer-Wells Haemostatic Forcep	225
Spherical Burr	496-497, 500
Spirit Lamp	657
Splinter Forcep	184-185
Spratt Bone Curette	544
Sputum Cup	655
St. Marks Pelvis Retractor	324

Alphabetical Index

S

	Page
Stacke (Silver) Probe	378
Standard Pattern	
Dissecting Forcep	149-150
Dressing Forcep	142
Steinert IOL Inserting Forcep	204
Steinhauser Bone Repositioning Forcep	579
Steinmann	
Extension Pins	505
Tendon Holding Forcep	577
Stella-S Facelift Scissor	134
Stellbrink Bone Rongeur	586
Stelzner Rectal Scissor	88-89
Stern-Gills Micro Scissor	106
Sternberg Retractor	327
Sternum Saw	493
Stevens Tenotomy Scissor	80-82, 136-137
Stieglitz Splinter Forcep	187
Stille	
Bone Chisel	524
Bone Gouge	524
Bone Osteotome	524
Bone Rongeur	591
Dissecting Forcep	152
Dissecting Scissor	35
Dressing Forcep	143-144
Drill Handle	496
Kidney Pedicle Clamp	264
Plaster of Paris Shear	485
Stille-Barraya Dissecting Forcep	162
Stille-Liston Bone Cutting Forcep	596
Stille-Luer Bone Rongeur	593
Stille-Ruskin Bone Rongeur	592
Stille-Sherman Hand Drill	496
Stockman Penis Clamp	646
Stone Dissecting Forcep	152
Strabismus Scissor	82-83
Strandell-Stille Retractor	300
Strassburger Modell Dissecting Forcep	165
Stratte Needle Holder	433, 461
Strauss	
Penis Clamp	646
Rectoscope	626-629
Strully	
Neurological Scissor	68
Vascular Scissor	67
Suction Haemorrhoidal Ligator	630

S

	Page
Suction Raspatory	405
Suction Tube	399-400
Swedish Periosteal Elevator	565
Syme	
Ligature Needle	471
Periosteal Elevator	554
Systrunk Nail Splitting Scissor	30

T

Tablet Tray	654
Taylor	
Dissecting Forcep	154-155
Dressing Forcep	145
Knee Retractor	573
Retractor	371
Taylor Mod. USA Percussion Hammer	388
Tendon Holding Forcep	578
Tendon Interlacing Forcep	578
Tendon Passing Instrument	576
Tendon Stripper	576
Tendon Tunnelling Forcep	577
Tennant Suture Tying Forcep	199
Tenotomy Scissor	55
Terrier Haemostatic Forcep	228
Thomas-Allis Intestinal & Tissue Grasping Forcep	607
Thorek Dissecting Scissor	50
Tibolt Punctal Scissor	102
Tissue Picker	294
Toennis	
Dissecting Scissor	69
Needle Holder	435, 467
Periosteal Elevator	566
Toennis-Adson Dissecting Scissor	69, 133
Tohoku Towel Clamp	276
Tonsil Needle	412-413
Toti Trepine	503
Towel Clamp	277
Townley Caliper	395
Traverse Self-Retaining Retractor	335
Trelat Periosteal Elevator	553
Trepine	496
Treves Dissecting Forcep	164
Trigeminal Knife	22

Alphabetical Index

T

	Page
Troutman	
Micro Needle Holder	444-445
Superior Rectus Forcep	196
Troutman-Castroviejo Corneoscleral Scissor	100
Troutman-Chris Blade Breaker	25
Troutman-Katzin Corneal Transplant Scissor	100
Tubing Clamp	278
Tudor-Edwards Retractor	316
Tuffier	
Abdominal Spatula	326
Haemostatic Forcep	226
Retractor	316
Tunneling Forcep	284
Tuohy Lumbar Puncture Needle	411
Turner Micro Dressing Forcep	145
Twist Drill	496-498, 501

U

Ulrich	
Bone Holding Forcep	584-585
Dressing Forcep	281
Fistula Knife	21
Universal	
Bandage Scissor	95
Tray	650-651
Trocar	399
Wire Cutting Scissor	90, 139
Unna Comedone Extractor	602-603
Unna-Vidal Comedone Extractor	604
Urethral Retractor	326
Uro Tangential Forcep	263
Utrata Capsulorhexis Forcep	198

V

Vacuum Cleaner	488
Van Buren	
Bone Holding Forcep	582
Urethral Sound	641-642

V

	Page
Vannas	
Capsulotomy Scissor	103-104
Micro Scissor	106-107, 109
Varady Varix Instrument	385-386
Vascular Scissor	59, 66-67
Vasectomy Dissecting Forcep	635
Vasectomy Fixation Clamp	635
Veidenheimer Sigmoid Anastomosis Clamp	618
Vein Cannula	411
Verbrugge Bone Holding Forcep	586
Verbrugge-Mueller Bone Lever	570
Verhoeven Suction Cannula	403
Vernier Calliper	395-396
Verres Insufflation Cannula	413
Very Delicate Operating Scissor	77-78
Vessel Clip, Mini	219
Vickers	
Bone Mallet	542
Low Profile Retractor	357-358
Vidal Lupus Scraper	601
Virchow	
Autopsy Knife	18
Brain Knife	19
Cartilage Knife	18
Skull Breaker	517
Vise Grip Plier	515
Vise Micro Jeweller Forcep	160
Volkmann	
Bone Curette	543-544, 549
Retractor	301-303
Vollmar	
Stripper	383-384
Vessel Irrigation Cannula	413

W

Wachenfeldt Clip Applying Forcep	482
Wagner	
Bone Gouge	531
Bone Lever	567
Operating Scissor	75
Periosteal Elevator	561
Waisted Saw Blade	487
Walb Post Mortem Knife	19

Alphabetical Index

W

	Page
Waldmann Nasal Scissor	73
Walton Finger Ring Saw	598
Wangensteen	
Dressing Forcep	213
Needle Holder	433, 462
Ward Periosteal Elevator	553
Wartenberg Sensibility Instrument	389
Wassmund Retractor	305
Watson Skin Graft Knife	23
Watson-Cheyne Periosteal Elevator	565
Watson-Jones Bone Lever	571
Waugh	
Dissecting Forcep	154
Dressing Forcep	147
Webster Needle Holder	428, 458-459
Wecker Iris Scissor	98-99
Weitlaner Self-Retaining Retractor	335-338
Weitlaner-Baby Self-Retaining Retractor	342
Weitlaner-Wullstein Self Retaining Retractor	339
Weller Dissecting Scissor	41
Wertheim	
Gynecological Scissor	38, 135
Hysterectomy Forcep	269, 271-272
Vaginal Clamp	267
Wertheim (Rogers) Hysterectomy Forcep	268
Wertheim-Cullen Vaginal Clamp	267
Westcott	
Stitch Scissor	102
Tenotomy Scissor	101-102
Wickstroem Dissecting & Ligature Forcep	261
Wies Chalazion Forcep	209
Williams Intestinal & Tissue Grasping Forcep	608
Williger	
Bone Curette	549-550
Bone Mallet	537, 539
Periosteal Elevator	561, 564
Wilson Haemostatic Forcep	244
Wire Cutting Plier	515-517
Wire Strainer	506
Wire Twisting Forcep	511-512
Wolff	
Lupus Curette	601
Plaster Breaker	486
Wound Retractor	294-295, 297-298, 301, 311
Wound Spreader	333
Wullstein Suction Tube	402-403

V

	Page
Yankauer Suction Tube	406-407
Yasargil	
Micro Forcep	167
Micro Needle Holder	438-439, 441
Micro Scissor	110
Suction Tube	404-405
Tumor Grasping Forcep	166
Yeoman (Turrell) Rectal Biopsy Forcep	631-633
Young	
Ligature Needle	469-470
Prostatic Retractor	640

Z

Zaufal-Jansen Bone Rongeur	590
Zenker	
Dissecting & Ligature Forcep	258
Retractor	310
Ziegler Head Mirror	391
Zielke Bone Gouge	532
Zoellner Suction Tube	402
Zweifel Needle Holder	434, 466



IT'S TIME TO TRY

ONE OF THE BEST INSTRUMENT SETS

Quality

United Kingdom

We focus on quality of our products more than anything else. Our products are made from German stainless steel by our highly experienced team.

Value

Affordable

We believe that quality should be affordable so to make it accessible and help improve patient health care. Our cost-effective instrument solutions help us realise this vision.

Warranty

Two Years

Hospita provides 24 months warranty for his instruments, retractors and other stainless steel products.



More Info Call Us:
+44 20 3432 6757



Visit Us for more
www.hospita.co